

Raoul Bott
Loring W. Tu

Differential Forms in Algebraic Topology

With 92 Illustrations



Springer-Verlag
New York Heidelberg Berlin

Raoul Bott
Department of Mathematics
Harvard University
Cambridge, Massachusetts 02138
USA

Loring W. Tu
Department of Mathematics
University of Michigan
Ann Arbor, Michigan 48109
USA

Editorial Board

P. R. Halmos
Managing Editor
Department of
Mathematics
Indiana University
Bloomington, IN 47401
USA

F. W. Gehring
Department of
Mathematics
University of Michigan
Ann Arbor, MI 48109
USA

C. C. Moore
Department of
Mathematics
University of California
Berkeley, CA 94720
USA

AMS Classifications: 57 Rxx, 58 Axx, 14 F40

Library of Congress Cataloging in Publication Data
Bott, Raoul, 1924-

Differential forms in algebraic topology.
(Graduate texts in mathematics; 82)
Bibliography: p.
Includes index.

1. Differential topology. 2. Algebraic
topology. 3. Differential forms. I. Tu,
Loring W. II. Title. III. Series.
QA613.6.B67 514'.72 81-9172
AACR2

© 1982 by Springer-Verlag New York Inc.
All rights reserved. No part of this book may be translated or reproduced in any
form without written permission from Springer-Verlag, 175 Fifth Avenue, New
York, New York 10010, U.S.A.

Printed in the United States of America.

9 8 7 6 5 4 3 2 1

ISBN 0-387-90613-4 Springer-Verlag New York Heidelberg Berlin
ISBN 3-540-90613-4 Springer-Verlag Berlin Heidelberg New York

Preface

The guiding principle in this book is to use differential forms as an aid in exploring some of the less digestible aspects of algebraic topology. Accordingly, we move primarily in the realm of smooth manifolds and use the de Rham theory as a prototype of all of cohomology. For applications to homotopy theory we also discuss by way of analogy cohomology with arbitrary coefficients.

Although we have in mind an audience with prior exposure to algebraic or differential topology, for the most part a good knowledge of linear algebra, advanced calculus, and point-set topology should suffice. Some acquaintance with manifolds, simplicial complexes, singular homology and cohomology, and homotopy groups is helpful, but not really necessary. Within the text itself we have stated with care the more advanced results that are needed, so that a mathematically mature reader who accepts these background materials on faith should be able to read the entire book with the minimal prerequisites.

There are more materials here than can be reasonably covered in a one-semester course. Certain sections may be omitted at first reading without loss of continuity. We have indicated these in the schematic diagram that follows.

This book is not intended to be foundational; rather, it is only meant to open some of the doors to the formidable edifice of modern algebraic topology. We offer it in the hope that such an informal account of the subject at a semi-introductory level fills a gap in the literature.

It would be impossible to mention all the friends, colleagues, and students whose ideas have contributed to this book. But the senior author would like on this occasion to express his deep gratitude, first of all to his primary topology teachers E. Specker, N. Steenrod, and

K. Reidemeister of thirty years ago, and secondly to H. Samelson, A. Shapiro, I. Singer, J.-P. Serre, F. Hirzebruch, A. Borel, J. Milnor, M. Atiyah, S.-s. Chern, J. Mather, P. Baum, D. Sullivan, A. Haefliger, and Graeme Segal, who, mostly in collaboration, have continued this word of mouth education to the present; the junior author is indebted to Allen Hatcher for having initiated him into algebraic topology. The reader will find their influence if not in all, then certainly in the more laudable aspects of this book. We also owe thanks to the many other people who have helped with our project: to Ron Donagi, Zbig Fiedorowicz, Dan Freed, Nancy Hingston, and Deane Yang for their reading of various portions of the manuscript and for their critical comments, to Ruby Aguirre, Lu Ann Custer, Barbara Moody, and Caroline Underwood for typing services, and to the staff of Springer-Verlag for its patience, dedication, and skill.

RAOUL BOTT

LORING TU

Contents

Introduction	1
CHAPTER I	
De Rham Theory	13
§1 The de Rham Complex on \mathbb{R}^n	13
The de Rham complex	13
Compact supports	17
§2 The Mayer-Vietoris Sequence	19
The functor Ω^*	19
The Mayer-Vietoris sequence	22
The functor Ω_c^* and the Mayer-Vietoris sequence for compact supports	25
§3 Orientation and Integration	27
Orientation and the integral of a differential form	27
Stokes' theorem	31
§4 Poincaré Lemmas	33
The Poincaré lemma for de Rham cohomology	33
The Poincaré lemma for compactly supported cohomology	37
The degree of a proper map	40
§5 The Mayer-Vietoris Argument	42
Existence of a good cover	42
Finite dimensionality of de Rham cohomology	43
Poincaré duality on an orientable manifold	44

The Künneth formula and the Leray–Hirsch theorem	47
The Poincaré dual of a closed oriented submanifold	50
§6 The Thom Isomorphism	53
Vector bundles and the reduction of structure groups	53
Operations on vector bundles	56
Compact cohomology of a vector bundle	59
Compact vertical cohomology and integration along the fiber	61
Poincaré duality and the Thom class	65
The global angular form, the Euler class, and the Thom class	70
Relative de Rham theory	78
§7 The Nonorientable Case	79
The twisted de Rham complex	79
Integration of densities, Poincaré duality, and the Thom isomorphism	85
CHAPTER II	
The Čech–de Rham Complex	89
§8 The Generalized Mayer–Vietoris Principle	89
Reformulation of the Mayer–Vietoris sequence	89
Generalization to countably many open sets and applications	92
§9 More Examples and Applications of the Mayer–Vietoris Principle	99
Examples: computing the de Rham cohomology from the combinatorics of a good cover	100
Explicit isomorphisms between the double complex and de Rham and Čech	102
The tic-tac-toe proof of the Künneth formula	105
§10 Presheaves and Čech Cohomology	108
Presheaves	108
Čech cohomology	110
§11 Sphere Bundles	113
Orientability	114
The Euler class of an oriented sphere bundle	116
The global angular form	121
Euler number and the isolated singularities of a section	122
Euler characteristic and the Hopf index theorem	126
§12 The Thom Isomorphism and Poincaré Duality Revisited	129
The Thom isomorphism	130
Euler class and the zero locus of a section	133
A tic-tac-toe lemma	135
Poincaré duality	139

§13	Monodromy	141
	When is a locally constant presheaf constant?	141
	Examples of monodromy	151
CHAPTER III		
	Spectral Sequences and Applications	154
§14	The Spectral Sequence of a Filtered Complex	155
	Exact couples	155
	The spectral sequence of a filtered complex	156
	The spectral sequence of a double complex	161
	The spectral sequence of a fiber bundle	169
	Some applications	170
	Product structures	174
	The Gysin sequence	177
	Leray's construction	179
§15	Cohomology with Integer Coefficients	182
	Singular homology	183
	The cone construction	184
	The Mayer-Vietoris sequence for singular chains	185
	Singular cohomology	188
	The homology spectral sequence	196
§16	The Path Fibration	197
	The path fibration	198
	The cohomology of the loop space of a sphere	203
§17	Review of Homotopy Theory	206
	Homotopy groups	206
	The relative homotopy sequence	212
	Some homotopy groups of the spheres	213
	Attaching cells	217
	Digression on Morse theory	220
	The relation between homotopy and homology	225
	$\pi_3(S^2)$ and the Hopf invariant	227
§18	Applications to Homotopy Theory	239
	Eilenberg-MacLane spaces	240
	The telescoping construction	241
	The cohomology of $K(\mathbb{Z}, 3)$	245
	The transgression	247
	Basic tricks of the trade	249
	Postnikov approximation	250
	Computation of $\pi_4(S^3)$	251

The Whitehead tower	252
Computation of $\pi_3(S^3)$	256
§19 Rational Homotopy Theory	258
Minimal models	259
Examples of Minimal Models	259
The main theorem and applications	262
CHAPTER IV	
Characteristic Classes	266
§20 Chern Classes of a Complex Vector Bundle	267
The first Chern class of a complex line bundle	267
The projectivization of a vector bundle	269
Main properties of the Chern classes	271
§21 The Splitting Principle and Flag Manifolds	273
The splitting principle	273
Proof of the Whitney product formula and the equality of the top Chern class and the Euler class	275
Computation of some Chern classes	278
Flag manifolds	282
§22 Pontrjagin Classes	285
Conjugate bundles	286
Realization and complexification	286
The Pontrjagin classes of a real vector bundle	289
Application to the embedding of a manifold in a Euclidean space	290
§23 The Search for the Universal Bundle	291
The Grassmannian	292
Digression on the Poincaré series of a graded algebra	294
The classification of vector bundles	297
The infinite Grassmannian	302
Concluding remarks	303
References	307
List of Notations	311
Index	319

Introduction

The most intuitively evident topological invariant of a space is the number of connected pieces into which it falls. Over the past one hundred years or so we have come to realize that this primitive notion admits in some sense two higher-dimensional analogues. These are the *homotopy* and *cohomology groups* of the space in question.

The evolution of the higher homotopy groups from the component concept is deceptively simple and essentially unique. To describe it, let $\pi_0(X)$ denote the set of path components of X and if p is a point of X , let $\pi_0(X, p)$ denote the set $\pi_0(X)$ with the path component of p singled out. Also, corresponding to such a point p , let $\Omega_p X$ denote the space of maps (continuous functions) of the unit circle $\{z \in \mathbb{C} : |z| = 1\}$ which send 1 to p , made into a topological space via the compact open topology. The path components of this so-called *loop space* $\Omega_p X$ are now taken to be the elements of $\pi_1(X, p)$:

$$\pi_1(X, p) = \pi_0(\Omega_p X, \bar{p}).$$

The composition of loops induces a group structure on $\pi_1(X, p)$ in which the constant map \bar{p} of the circle to p plays the role of the identity; so endowed, $\pi_1(X, p)$ is called the *fundamental group* or the *first homotopy group* of X at p . It is in general not Abelian. For instance, for a Riemann surface of genus 3, as indicated in the figure below:

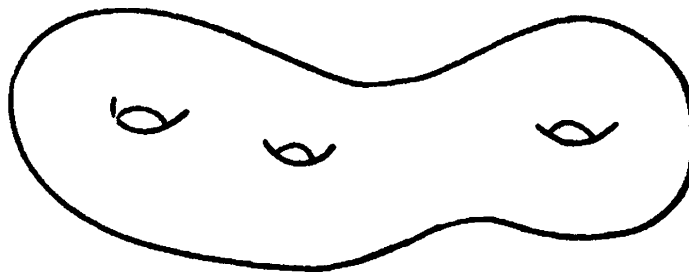

$\pi_1(X, p)$ is generated by six elements $\{x_1, x_2, x_3, y_1, y_2, y_3\}$ subject to the single relation

$$\prod_{i=1}^3 [x_i, y_i] = 1,$$

where $[x_i, y_i]$ denotes the commutator and 1 the identity. The fundamental group is in fact sufficient to classify the closed oriented 2-dimensional surfaces, but is insufficient in higher dimensions.

To return to the general case, all the higher homotopy groups $\pi_k(X, p)$ for $k \geq 2$ can now be defined through the inductive formula:

$$\pi_{k+1}(X, p) = \pi_k(\Omega_p X, \bar{p}).$$

By the way, if p and p' are two points in X in the same path component, then

$$\pi_k(X, p) \simeq \pi_k(X, p'),$$

but the correspondence is not necessarily unique. For the Riemann surfaces such as discussed above, the higher π_k 's for $k \geq 2$ are all trivial, and it is in part for this reason that π_1 is sufficient to classify them. The groups π_k for $k \geq 2$ turn out to be Abelian and therefore do not seem to have been taken seriously until the 1930's when W. Hurewicz defined them (in the manner above, among others) and showed that, far from being trivial, they constituted the basic ingredients needed to describe the homotopy-theoretic properties of a space.

The great drawback of these easily defined invariants of a space is that they are very difficult to compute. To this day not all the homotopy groups of say the 2-sphere, i.e., the space $x^2 + y^2 + z^2 = 1$ in \mathbb{R}^3 , have been computed! Nonetheless, by now much is known concerning the general properties of the homotopy groups, largely due to the formidable algebraic techniques to which the "cohomological extension" of the component concept lends itself, and the relations between homotopy and cohomology which have been discovered over the years.

This cohomological extension starts with the dual point of view in which a component is characterized by the property that on it *every locally constant function is globally constant*. Such a component is sometimes called a connected component, to distinguish it from a *path component*. Thus, if we define $H^0(X)$ to be the vector space of real-valued *locally constant* functions on X , then $\dim H^0(X)$ tells us the number of connected components of X . Note that on reasonable spaces where path components and connected components agree, we therefore have the formula

$$\text{cardinality } \pi_0(X) = \dim H^0(X).$$

Still the two concepts are dual to each other, the first using maps of the unit interval into X to test for connectedness and the second using maps of X

into \mathbb{R} for the same purpose. One further difference is that the cohomology group $H^0(X)$ has, by fiat, a natural \mathbb{R} -module structure.

Now what should the proper higher-dimensional analogue of $H^0(X)$ be? Unfortunately there is no decisive answer here. Many plausible definitions of $H^k(X)$ for $k > 0$ have been proposed, all with slightly different properties but all isomorphic on "reasonable spaces". Furthermore, in the realm of differentiable manifolds, all these theories coincide with the *de Rham theory* which makes its appearance there and constitutes in some sense the most perfect example of a cohomology theory. The de Rham theory is also unique in that it stands at the crossroads of topology, analysis, and physics, enriching all three disciplines.

The gist of the "de Rham extension" is comprehended most easily when M is assumed to be an open set in some Euclidean space \mathbb{R}^n , with coordinates x_1, \dots, x_n . Then amongst the C^∞ functions on M the locally constant ones are precisely those whose gradient

$$df = \sum \frac{\partial f}{\partial x_i} dx_i$$

vanishes identically. Thus here $H^0(M)$ appears as the space of solutions of the differential equation $df = 0$. This suggests that $H^1(M)$ should also appear as the space of solutions of some natural differential equations on the manifold M . Now consider a 1-form on M :

$$\theta = \sum a_i dx_i,$$

where the a_i 's are C^∞ functions on M . Such an expression can be integrated along a smooth path γ , so that we may think of θ as a function on paths γ :

$$\gamma \mapsto \int_\gamma \theta.$$

It then suggests itself to seek those θ which give rise to *locally constant* functions of γ , i.e., for which the integral $\int_\gamma \theta$ is left unaltered under small variations of γ —but keeping the endpoints fixed! (Otherwise, only the zero 1-form would be locally constant.) Stokes' theorem teaches us that these line integrals are characterized by the differential equations:

$$\frac{\partial a_i}{\partial x_j} - \frac{\partial a_j}{\partial x_i} = 0 \quad (\text{written } d\theta = 0).$$

On the other hand, the fundamental theorem of calculus implies that $\int_\gamma df = f(Q) - f(P)$, where P and Q are the endpoints of γ , so that *the gradients are trivially locally constant*.

One is here irresistibly led to the definition of $H^1(M)$ as the vector space of *locally constant line integrals modulo the trivially constant ones*. Similarly the higher cohomology groups $H^k(M)$ are defined by simply replacing line integrals with their higher-dimensional analogues, the *k-volume integrals*

The Grassmann calculus of exterior differential forms facilitates these extensions quite magically. Moreover, the differential equations characterizing the locally constant k -integrals are seen to be C^∞ invariants and so extend naturally to the class of C^∞ manifolds.

Chapter I starts with a rapid account of this whole development, assuming little more than the standard notions of advanced calculus, linear algebra and general topology. A nodding acquaintance with singular homology or cohomology helps, but is not necessary. No real familiarity with differential geometry or manifold theory is required. After all, the concept of a manifold is really a very natural and simple extension of the calculus of several variables, as our fathers well knew. Thus for us a manifold is essentially a space constructed from open sets in \mathbb{R}^n by patching them together in a smooth way. This point of view goes hand in hand with the "computability" of the de Rham theory. Indeed, the decisive difference between the π_k 's and the H^k 's in this regard is that if a manifold X is the union of two open submanifolds U and V :

$$X = U \cup V,$$

then the cohomology groups of U , V , $U \cap V$, and X are linked by a much stronger relation than the homotopy groups are. The linkage is expressed by the exactness of the following sequence of linear maps, the Mayer-Vietoris sequence:

$$\begin{array}{ccccccc} & & H^{k+1}(X) & \rightarrow & & & \\ & & \curvearrowleft & & d^* & & \\ & & \text{-----} & & \text{-----} & & \\ & & H^k(X) & \rightarrow & H^k(U) \oplus H^k(V) & \rightarrow & H^k(U \cap V) \\ & & \curvearrowright & & d^* & & \\ & & \text{-----} & & \text{-----} & & \\ & & & & & & \rightarrow H^{k-1}(U \cap V) \\ & & 0 & \rightarrow & H^0(X) & \rightarrow & \dots \end{array}$$

starting with $k = 0$ and extending up indefinitely. In this sequence every arrow stands for a linear map of the vector spaces and exactness asserts that the kernel of each map is precisely the image of the preceding one. The horizontal arrows in our diagram are the more or less obvious ones induced by restriction of functions, but the coboundary operator d^* is more subtle and uses the existence of a *partition of unity* subordinate to the cover $\{U, V\}$ of X , that is, smooth functions ρ_U and ρ_V such that the first has support in U , the second has support in V , and $\rho_U + \rho_V \equiv 1$ on X . The simplest relation imaginable between the H^k 's of U , V , and $U \cup V$ would of course be that H^k behaves additively; the Mayer-Vietoris sequence teaches us that this is indeed the case if U and V are disjoint. Otherwise, there is a geometric feedback from $H^k(U \cap V)$ described by d^* , and one of the hallmarks of a topologist is a sound intuition for this d^* .

The exactness of the Mayer-Vietoris sequence is our first goal once the basics of the de Rham theory are developed. Thereafter we establish the

second essential property for the computability of the theory, namely that for a smoothly contractible manifold M ,

$$H^k(M) = \begin{cases} \mathbb{R} & \text{for } k = 0, \\ 0 & \text{for } k > 0. \end{cases}$$

This *homotopy invariance* of the de Rham theory can again be thought of as having evolved from the fundamental theorem of calculus. Indeed, the formula

$$f(x) dx = d \int_0^x f(u) du$$

shows that every line integral (1-form) on \mathbb{R}^1 is a gradient, whence $H^1(\mathbb{R}^1) = 0$. The homotopy invariance is thus established for the real line. This argument also paves the way for the general case.

The two properties that we have just described constitute a verification of the *Eilenberg–Steenrod axioms* for the de Rham theory in the present context. Combined with a little geometry, they can be used in a standard manner to compute the cohomology of simple manifolds. Thus, for spheres one finds

$$H^k(S^n) = \begin{cases} \mathbb{R} & \text{for } k = 0 \text{ or } n \\ 0 & \text{otherwise,} \end{cases}$$

while for a Riemann surface X_g with g holes,

$$H^k(X_g) = \begin{cases} \mathbb{R} & \text{for } k = 0 \text{ or } 2 \\ \mathbb{R}^{2g} & \text{for } k = 1 \\ 0 & \text{otherwise.} \end{cases}$$

A more systematic treatment in Chapter II leads to the computability proper of the de Rham theory in the following sense. By a finite good cover of M we mean a covering $\mathcal{U} = \{U_\alpha\}_{\alpha=1}^N$ of M by a finite number of open sets such that all intersections $U_{\alpha_1} \cap \dots \cap U_{\alpha_m}$ are either vacuous or contractible. The purely combinatorial data that specify for each subset $\{\alpha_1, \dots, \alpha_k\}$ of $\{1, \dots, N\}$ which of these two alternatives holds are called the incidence data of the cover. The computability of the theory is the assertion that it can be computed purely from such incidence data. Along lines established in a remarkable paper by André Weil [1], we show this to be the case for the de Rham theory. Weil's point of view constitutes an alternate approach to the sheaf theory of Leray and was influential in Cartan's *theorie des carapaces*. The beauty of his argument is that it can be read both ways: either to prove the computability of de Rham or to prove the topological invariance of the combinatorial prescription.

To digress for a moment, it is difficult not to speculate about what kept Poincaré from discovering this argument forty years earlier. One has the feeling that he already knew every step along the way. After all, the homotopy invariance of the de Rham theory for \mathbb{R}^n is known as the Poincaré

lemma! Nevertheless, he veered sharply from this point of view, thinking predominantly in terms of triangulations, and so he in fact was never able to prove either the computability of de Rham or the invariance of the combinatorial definition. Quite possibly the explanation is that the whole C^∞ point of view and, in particular, the partitions of unity were alien to him and his contemporaries, steeped as they were in real or complex analytic questions.

De Rham was of course the first to prove the topological invariance of the theory that now bears his name. He showed that it was isomorphic to the *singular cohomology*, which is trivially—i.e., by definition—topologically invariant. On the other hand, André Weil's approach relates the de Rham theory to the *Čech theory*, which is again topologically invariant.

But to return to the plan of our book, the bulk of Chapter I is actually devoted to explaining the fundamental symmetry in the cohomology of a compact oriented manifold. In its most primitive form this symmetry asserts that

$$\dim H^q(M) = \dim H^{n-q}(M).$$

Poincaré seems to have immediately realized this consequence of the locally Euclidean nature of a manifold. He saw it in terms of dual subdivisions, which turn the incidence relations upside down. In the de Rham theory the duality derives from the intrinsic pairing between differential forms of arbitrary and compact support. Indeed consider the de Rham theory of \mathbb{R}^1 with compactly supported forms. Clearly the only function with compact support on \mathbb{R}^1 is the zero function. As for 1-forms, not every 1-form $g dx$ is now a gradient of a *compactly supported* function f ; this happens if and only if $\int_{-\infty}^{\infty} g dx = 0$. Thus we see that the compactly supported de Rham theory of \mathbb{R}^1 is given by

$$H_c^k(\mathbb{R}^1) = \begin{cases} 0 & \text{for } k = 0 \\ \mathbb{R} & \text{for } k = 1, \end{cases}$$

and is just the de Rham theory “upside down.” This phenomenon now extends inductively to \mathbb{R}^n and is finally propagated via the Mayer-Vietoris sequence to the cohomology of any compact oriented manifold.

One virtue of the de Rham theory is that the essential mechanism of this duality is via the familiar operation of integration, coupled with the natural ring structure of the theory: a p -form θ can be multiplied by a q -form ϕ to produce a $(p+q)$ -form $\theta \wedge \phi$. This multiplication is “commutative in the graded sense”:

$$\theta \wedge \phi = (-1)^{pq} \phi \wedge \theta.$$

(By the way, the commutativity of the de Rham theory is another reason why it is more “perfect” than its other more general brethren, which become commutative only on the cohomology level.) In particular, if ϕ has compact support and is of dimension $n-p$, where $n = \dim M$, then inte-

gration over M gives rise to a pairing

$$(\theta, \phi) \rightarrow \int_M \theta \wedge \phi,$$

which descends to cohomology and induces a pairing

$$H^p(M) \otimes H_c^{n-p}(M) \rightarrow \mathbb{R}.$$

A more sophisticated version of Poincaré duality is then simply that *the pairing above is dual*; that is, it establishes the two spaces as duals of each other.

Although we return to Poincaré duality over and over again throughout the book, we have not attempted to give an exhaustive treatment. (There is, for instance, no mention of Alexander duality or other phenomena dealing with relative, rather than absolute, theory.) Instead, we chose to spend much time bringing Poincaré duality to life by explicitly constructing the Poincaré dual of a submanifold N in M . The problem is the following. Suppose $\dim N = k$ and $\dim M = n$, both being compact oriented. Integration of a k -form ω on M over N then defines a linear functional from $H^k(M)$ to \mathbb{R} , and so, by Poincaré duality, must be represented by a cohomology class in $H^{n-k}(M)$. The question is now: how is one to construct a representative of this Poincaré dual for N , and can such a representative be made to have support arbitrarily close to N ?

When N reduces to a point p in M , this question is easily answered. The dual of p is represented by any n -form ω with support in the component M_p of p and with total mass 1, that is, with

$$\int_{M_p} \omega = 1.$$

Note also that such an ω can be found with support in an arbitrarily small neighborhood of p , by simply choosing coordinates on M centered at p , say x_1, \dots, x_n , and setting

$$\omega = \lambda(x) dx_1 \dots dx_n$$

with λ a bump function of mass 1. (In the limit, thinking of Dirac's δ -function as the Poincaré dual of p leads us to de Rham's theory of currents.)

When the point p is replaced by a more general submanifold N , it is easy to extend this argument, provided N has a *product neighborhood* $D(N)$ in M in the sense that $D(N)$ is diffeomorphic to the product $N \times D^{n-k}$, where D^{n-k} is a disk of the dimension indicated. However, this need not be the case! Just think of the center circle in a Möbius band. Its neighborhoods are at best smaller Möbius bands.

In the process of constructing the Poincaré dual we are thus confronted by the preliminary question of how to measure the possible twistings of neighborhoods of N in M and to correct for the twist. This is a subject in its own right nowadays, but was initiated by H. Whitney and H. Hopf in just

the present context during the Thirties and Forties. Its trade name is *fiber bundle theory* and the cohomological measurements of the global twist in such "local products" as $D(N)$ are referred to as *characteristic classes*. In the last forty years the theory of characteristic classes has grown to such an extent that we cannot do it justice in our book. Still, we hope to have covered it sufficiently so that the reader will be able to see its ramifications in both differential geometry and topology. We also hope that our account could serve as a good introduction to the connection between characteristic classes and the global aspects of the gauge theories of modern physics.

That a connection between the equations of mathematical physics and topology might exist is not too surprising in view of the classical theory of electricity. Indeed, in a vacuum the electromagnetic field is represented by a 2-form in the (x, y, z, t) -space:

$$\omega = (E_x dx + E_y dy + E_z dz)dt + H_x dy dz - H_y dx dz + H_z dx dy,$$

and the form ω is locally constant in our sense, i.e., $d\omega = 0$. Relative to the Lorentz metric in \mathbb{R}^4 the *star* of ω is defined to be

$$*\omega = -(H_x dx + H_y dy + H_z dz)dt + E_x dy dz - E_y dx dz + E_z dx dz,$$

and Maxwell's equations simply assert that both ω and its star are closed: $d\omega = 0$ and $d*\omega = 0$. In particular, the cohomology class of $*\omega$ is a well defined object and is often of physical interest.

To take the simplest example, consider the Coulomb potential of a point charge q at rest in the origin of our coordinate system. The field ω generated by this charge then has the description

$$\omega = -d\left(\frac{1}{r} \cdot dt\right)$$

with $r = (x^2 + y^2 + z^2)^{1/2} \neq 0$. Thus ω is defined on $\mathbb{R}^4 - \mathbb{R}_t$, where \mathbb{R}_t denotes the t -axis. The de Rham cohomology of this set is easily computed to be

$$H^k(\mathbb{R}^4 - \mathbb{R}_t) = \begin{cases} \mathbb{R} & \text{for } k = 0, 2 \\ 0 & \text{otherwise.} \end{cases}$$

The form ω is manifestly cohomologically uninteresting, since it is d of a 1-form and so is trivially "closed", i.e., locally constant. On the other hand the $*$ of ω is given by

$$*\omega = \frac{q}{4\pi} \frac{x dy dz - y dx dz + z dx dy}{r^3},$$

which turns out to generate H^2 . The cohomology class of $*\omega$ can thus be interpreted as the charge of our source.

In seeking differential equations for more sophisticated phenomena than electricity, the modern physicists were led to equations (the Yang-Mills) which fit perfectly into the framework of characteristic classes as developed by such masters as Pontrjagin and Chern during the Forties.

Having sung the praises of the de Rham theory, it is now time to admit its limitations. The trouble with it, is that it only tells part of the cohomology story and from the point of view of the homotopy theorists, only the simplest part. The de Rham theory ignores torsion phenomena. To explain this in a little more detail, recall that the homotopy groups do not behave well under the union operation. However, they behave very well under Cartesian products. Indeed, as is quite easily shown,

$$\pi_q(X \times Y) = \pi_q(X) \oplus \pi_q(Y).$$

More generally, consider the situation of a fiber bundle (twisted product). Here we are dealing with a space E mapped onto a space X with the fibers—i.e., the inverse images of points—all homeomorphic in some uniform sense to a fixed space Y . For fiber bundles, the additivity of π_q is stretched into an infinite exact sequence of Mayer-Vietoris type, however now going in the opposite direction:

$$\cdots \rightarrow \pi_q(Y) \rightarrow \pi_q(E) \rightarrow \pi_q(X) \rightarrow \pi_{q-1}(Y) \rightarrow \cdots$$

This phenomenon is of course fundamental in studying the twist we talked about earlier, but it also led the homotopy theorists to the conjecture that in their much more flexible homotopy category, where objects are considered equal if they can be deformed into each other, every space factors into a twisted product of irreducible prime factors. This turns out to be true and is called the *Postnikov decomposition* of the space. Furthermore, the "prime spaces" in this context all have nontrivial homotopy groups in only one dimension. Now in the homotopy category such a prime space, say with nontrivial homotopy group π in dimension n , is determined uniquely by π and n and is denoted $K(\pi, n)$. These $K(\pi, n)$ -spaces of Eilenberg and MacLane therefore play an absolutely fundamental role in homotopy theory. They behave well under the standard group operations. In particular, corresponding to the usual decomposition of a finitely generated Abelian group:

$$\pi = \left(\bigoplus_p \pi^{(p)} \right) \oplus \mathbb{Z}^r$$

into p -primary parts and a free part (said to correspond to the prime at infinity), the $K(\pi, n)$ will factor into a product

$$K(\pi, n) = \left(\prod_p K(\pi^{(p)}, n) \right) \cdot K(\mathbb{Z}, n)^r.$$

It follows that in homotopy theory, just as in many questions of number theory, one can work one prime at a time. In this framework it is now quite easy to explain the shortcomings of the de Rham theory: the theory is sensitive only to the prime at infinity!

After having encountered the Čech theory in Chapter II, we make in Chapter III the now hopefully easy transition to cohomology with coefficients in an arbitrary Abelian group. This theory, say with coefficients in the

integers, is then sensitive to all the p -primary phenomena in homotopy theory.

The development sketched here is discussed in greater detail in Chapter III, where we also apply the ideas to the computation of some relatively simple homotopy groups. All these computations in the final analysis derive from Serre's brilliant idea of applying the spectral sequence of Leray to homotopy problems and from his coining of a sufficiently general definition of a twisted product, so that, as the reader will see, the Postnikov decomposition in the form we described it, is a relatively simple matter. It remains therefore only to say a few words to the uninitiated about what this "spectral sequence" is.

We remarked earlier that homotopy behaves additively under products. On the other hand, cohomology does not. In fact, neglecting matters of torsion, i.e., reverting to the de Rham theory, one has the *Künneth formula*:

$$H^k(X \times Y) = \sum_{p+q=k} H^p(X) \otimes H^q(Y).$$

The next question is of course how cohomology behaves for twisted products. It is here that Leray discovered some a priori bounds on the extent and manner in which the Künneth formula can fail due to a twist. For instance, one of the corollaries of his spectral sequence is that if X and Y have vanishing cohomology in positive dimensions less than p and q respectively, then however one twists X with Y , the Künneth formula will hold up to dimension $d < \min(p, q)$.

Armed with this sort of information, one can first of all compute the early part of the cohomology of the $K(\pi, n)$ inductively, and then deduce which $K(\pi, n)$ must occur in a Postnikov decomposition of X by comparing the cohomology on both sides. This procedure is of course at best ad hoc, and therefore gives us only fragmentary results. Still, the method points in the right direction and can be codified to prove the computability (in the logical sense) of any particular homotopy group, of a sphere, say. This theorem is due to E. Brown in full generality. Unfortunately, however, it is not directly applicable to explicit calculations—even with large computing machines.

So far this introduction has been written with a lay audience in mind. We hope that what they have read has made sense and has whetted their appetites. For the more expert, the following summary of the plan of our book might be helpful.

In Chapter I we bring out from scratch Poincaré duality and its various extensions, such as the Thom isomorphism, all in the de Rham category. Along the way all the axioms of a cohomology theory are encountered, but at first treated only in our restricted context.

In Chapter II we introduce the techniques of spectral sequences as an extension of the Mayer-Vietoris principle and so are led to A. Weil's Čech-de Rham theory. This theory is later used as a bridge to cohomology

in general and to integer cohomology in particular. We spend considerable time patching together the Euler class of a sphere bundle and exploring its relation to Poincaré duality. We also very briefly present the sheaf-theoretic proof of this duality.

In Chapter III we come to grips with spectral sequences in a more formal manner and describe some of their applications to homotopy theory, for example, to the computation of $\pi_3(S^3)$. This chapter is less self-contained than the others and is meant essentially as an introduction to homotopy theory proper. In the same spirit we close with a short account of Sullivan's rational homotopy theory.

Finally, in Chapter IV we use the Grothendieck approach towards characteristic classes to give a more or less self-contained treatment of Chern and Pontrjagin classes. We then relate them to the cohomology of the infinite Grassmannian.

Unfortunately there was no time left within the scope of our book to explain the functorial approach to classifying spaces in general and to make the connection with the Eilenberg–MacLane spaces. We had to relegate this material, which is most naturally explained in the framework of semi-simplicial theory, to a mythical second volume. The novice should also be warned that there are all too many other topics which we have not mentioned. These include generalized cohomology theories, cohomology operations, and the Adams and Eilenberg–Moore spectral sequences. Alas, there is also no mention of the truly geometric achievements of modern topology, that is, handlebody theory, surgery theory, and the structure theory of differentiable and piecewise linear manifolds. Still, we hope that our volume serves as an introduction to all this as well as to such topics in analysis as Hodge theory and the Atiyah–Singer index theorems for elliptic differential operators.

CHAPTER I

de Rham Theory

§1 The de Rham Complex on \mathbb{R}^n

To start things off we define in this section the de Rham cohomology and compute a few examples. This will turn out to be the most important diffeomorphism invariant of a manifold. So let x_1, \dots, x_n be the linear coordinates on \mathbb{R}^n . We define Ω^* to be the algebra over \mathbb{R} generated by dx_1, \dots, dx_n with the relations

$$\begin{cases} (dx_i)^2 = 0 \\ dx_i dx_j = -dx_j dx_i, i \neq j. \end{cases}$$

As a vector space over \mathbb{R} , Ω^* has basis

$$1, dx_i, dx_i dx_j, dx_i dx_j dx_k, \dots, dx_{i_1} \dots dx_{i_k},$$

$$i < j \quad i < j < k$$

The C^∞ differential forms on \mathbb{R}^n are elements of

$$\Omega^*(\mathbb{R}^n) = \{C^\infty \text{ functions on } \mathbb{R}^n\} \otimes_{\mathbb{R}} \Omega^*.$$

Thus, if ω is such a form, then ω can be uniquely written as $\sum f_{i_1 \dots i_k} dx_{i_1} \dots dx_{i_k}$ where the coefficients $f_{i_1 \dots i_k}$ are C^∞ functions. We also write $\omega = \sum f_I dx_I$. The algebra $\Omega^*(\mathbb{R}^n) = \bigoplus_{q=0}^n \Omega^q(\mathbb{R}^n)$ is naturally graded, where $\Omega^q(\mathbb{R}^n)$ consists of the C^∞ q -forms on \mathbb{R}^n . There is a differential operator

$$d : \Omega^q(\mathbb{R}^n) \rightarrow \Omega^{q+1}(\mathbb{R}^n),$$

defined as follows:

- i) if $f \in \Omega^0(\mathbb{R}^n)$, then $df = \sum \partial f / \partial x_i dx_i$
- ii) if $\omega = \sum f_I dx_I$, then $d\omega = \sum df_I dx_I$.

EXAMPLE 1.1. If $\omega = x dy$, then $d\omega = dx dy$.

This d , called the *exterior differentiation*, is the ultimate abstract extension of the usual gradient, curl, and divergence of vector calculus on \mathbb{R}^3 , as the example below partially illustrates.

EXAMPLE 1.2. On \mathbb{R}^3 , $\Omega^0(\mathbb{R}^3)$ and $\Omega^3(\mathbb{R}^3)$ are each 1-dimensional and $\Omega^1(\mathbb{R}^3)$ and $\Omega^2(\mathbb{R}^3)$ are each 3-dimensional over the C^∞ functions, so the following identifications are possible:

$$\begin{array}{ccccc} \{\text{functions}\} & \simeq & \{0\text{-forms}\} & \simeq & \{3\text{-forms}\} \\ f & \leftrightarrow & f & \leftrightarrow & f dx dy dz \end{array}$$

and

$$\{\text{vector fields}\} \simeq \{1\text{-forms}\} \simeq \{2\text{-forms}\}$$

$$X = (f_1, f_2, f_3) \leftrightarrow f_1 dx + f_2 dy + f_3 dz \leftrightarrow f_1 dy dz - f_2 dx dz + f_3 dx dy.$$

On functions,

$$df = \frac{\partial f}{\partial x} dx + \frac{\partial f}{\partial y} dy + \frac{\partial f}{\partial z} dz.$$

On 1-forms,

$$\begin{aligned} d(f_1 dx + f_2 dy + f_3 dz) \\ = \left(\frac{\partial f_3}{\partial y} - \frac{\partial f_2}{\partial z} \right) dy dz - \left(\frac{\partial f_1}{\partial z} - \frac{\partial f_3}{\partial x} \right) dx dz + \left(\frac{\partial f_2}{\partial x} - \frac{\partial f_1}{\partial y} \right) dx dy. \end{aligned}$$

On 2-forms,

$$d(f_1 dy dz - f_2 dx dz + f_3 dx dy) = \left(\frac{\partial f_1}{\partial x} + \frac{\partial f_2}{\partial y} + \frac{\partial f_3}{\partial z} \right) dx dy dz.$$

In summary,

$$\left. \begin{array}{l} d(0\text{-forms}) = \text{gradient,} \\ d(1\text{-forms}) = \text{curl,} \\ d(2\text{-forms}) = \text{divergence.} \end{array} \right\}$$

The wedge product of two differential forms, written $\tau \wedge \omega$ or $\tau \cdot \omega$, is defined as follows: if $\tau = \sum f_i dx_i$ and $\omega = \sum g_j dx_j$, then

$$\tau \wedge \omega = \sum f_i g_j dx_i dx_j.$$

Note that $\tau \wedge \omega = (-1)^{\text{deg } \tau \cdot \text{deg } \omega} \omega \wedge \tau$.

Proposition 1.3. d is an antiderivation, i.e.,

$$d(\tau \cdot \omega) = (d\tau) \cdot \omega + (-1)^{\text{deg } \tau} \tau \cdot d\omega.$$

PROOF. By linearity it suffices to check on monomials

$$\begin{aligned}\tau &= f_i dx_i, \quad \omega = g_j dx_j. \\ d(\tau \cdot \omega) &= d(f_i g_j) dx_i dx_j = (df_i)g_j dx_i dx_j + f_i dg_j dx_i dx_j \\ &= (d\tau) \cdot \omega + (-1)^{\deg \tau} \tau \cdot d\omega.\end{aligned}$$

On the level of functions $d(fg) = (df)g + f(dg)$ is simply the ordinary product rule. \square

Proposition 1.4. $d^2 = 0$.

PROOF. This is basically a consequence of the fact that the mixed partials are equal. On functions,

$$d^2 f = d\left(\sum_i \frac{\partial f}{\partial x_i} dx_i\right) = \sum_{i,j} \frac{\partial^2 f}{\partial x_j \partial x_i} dx_j dx_i.$$

Here the factors $\partial^2 f / \partial x_j \partial x_i$ are symmetric in i, j while $dx_j dx_i$ are skew-symmetric in i, j ; hence $d^2 f = 0$. On forms $\omega = f_i dx_i$,

$$d^2 \omega = d^2(f_i dx_i) = d(df_i dx_i) = 0$$

by the previous computation and the antiderivation property of d . \square

The complex $\Omega^*(\mathbb{R}^n)$ together with the differential operator d is called the de Rham complex on \mathbb{R}^n . The kernel of d are the closed forms and the image of d , the exact forms. The de Rham complex may be viewed as a God-given set of differential equations, whose solutions are the closed forms. For instance, finding a closed 1-form $f dx + g dy$ on \mathbb{R}^2 is tantamount to solving the differential equation $\partial g / \partial x - \partial f / \partial y = 0$. By Proposition 1.4 the exact forms are automatically closed; these are the trivial or "uninteresting" solutions. A measure of the size of the space of "interesting" solutions is the definition of the de Rham cohomology.

Definition. The q -th de Rham cohomology of \mathbb{R}^n is the vector space

$$H_{DR}^q(\mathbb{R}^n) = \{\text{closed } q\text{-forms}\} / \{\text{exact } q\text{-forms}\}.$$

We sometimes suppress the subscript DR and write $H^q(\mathbb{R}^n)$. If there is a need to distinguish between a form ω and its cohomology class, we denote the latter by $[\omega]$.

Note that all the definitions so far work equally well for any open subset U of \mathbb{R}^n ; for instance,

$$\Omega^*(U) = \{C^\infty \text{ functions on } U\} \otimes_{\mathbb{R}} \Omega^*.$$

So we may also speak of the de Rham cohomology $H_{DR}^q(U)$ of U .

EXAMPLES 1.5.

(a) $n = 0$

$$H^q = \begin{cases} \mathbb{R} & q = 0 \\ 0 & q > 0. \end{cases}$$

(b) $n = 1$ Since $(\ker d) \cap \Omega^0(\mathbb{R}^1)$ are the constant functions,

$$H^0(\mathbb{R}^1) = \mathbb{R}.$$

On $\Omega^1(\mathbb{R}^1)$, $\ker d$ are all the 1-forms.If $\omega = g(x)dx$ is a 1-form, then by taking

$$f = \int_0^x g(u) du,$$

we find that

$$df = g(x) dx.$$

Therefore every 1-form on \mathbb{R}^1 is exact and

$$H^1(\mathbb{R}^1) = 0.$$

(c) Let U be a disjoint union of m open intervals on \mathbb{R}^1 .

Then

$$H^0(U) = \mathbb{R}^m$$

and

$$H^1(U) = 0.$$

(d) In general

$$H^*(\mathbb{R}^n) = \begin{cases} \mathbb{R} & \text{in dimension } 0, \\ 0 & \text{otherwise.} \end{cases}$$

This result is called the *Poincaré lemma* and will be proved in Section 4.

The de Rham complex is an example of a differential complex. For the convenience of the reader we recall here some basic definitions and results on differential complexes. A direct sum of vector spaces $C = \bigoplus_{q \in \mathbb{Z}} C^q$ indexed by the integers is called a differential complex if there are homomorphisms

$$\dots \longrightarrow C^{q-1} \xrightarrow{d} C^q \xrightarrow{d} C^{q+1} \longrightarrow \dots$$

such that $d^2 = 0$. d is the *differential operator* of the complex C . The *cohomology* of C is the direct sum of vector spaces $H(C) = \bigoplus_{q \in \mathbb{Z}} H^q(C)$, where

$$H^q(C) = (\ker d \cap C^q) / (\text{im } d \cap C^q).$$

A map $f: A \rightarrow B$ between two differential complexes is a chain map if it commutes with the differential operators of A and B : $f d_A = d_B f$.

A sequence of vector spaces

$$\cdots \longrightarrow V_{i-1} \xrightarrow{f_{i-1}} V_i \xrightarrow{f_i} V_{i+1} \longrightarrow \cdots$$

is said to be exact if for all i the kernel of f_i is equal to the image of its predecessor f_{i-1} . An exact sequence of the form

$$0 \longrightarrow A \longrightarrow B \longrightarrow C \longrightarrow 0$$

is called a short exact sequence. Given a short exact sequence of differential complexes

$$0 \longrightarrow A \xrightarrow{f} B \xrightarrow{g} C \longrightarrow 0$$

in which the maps f and g are chain maps, there is a long exact sequence of cohomology groups

$$\begin{array}{c} \curvearrowright H^{q+1}(A) \longrightarrow \cdots \xrightarrow{f^*} \\ \curvearrowright H^q(A) \xrightarrow{f^*} H^q(B) \xrightarrow{g^*} H^q(C) \end{array}$$

In this sequence f^* and g^* are the naturally induced maps and $d^*[c]$, $c \in C^q$, is obtained as follows:

$$\begin{array}{ccccccc} & & \uparrow & & \uparrow & & \uparrow \\ 0 & \longrightarrow & A^{q+1} & \xrightarrow{f} & B^{q+1} & \xrightarrow{g} & C^{q+1} \longrightarrow 0 \\ & & \uparrow & & \uparrow & & \uparrow \\ 0 & \longrightarrow & A^q & \xrightarrow{f} & B^q & \xrightarrow{g} & C^q \longrightarrow 0 \\ & & \uparrow & & \uparrow & & \uparrow \\ & & & & d & & d \\ & & & & \uparrow & & \uparrow \\ & & & & & & c \end{array}$$

By the surjectivity of g there is an element b in B^q such that $g(b) = c$. Because $g(db) = d(gb) = dc = 0$, $db = f(a)$ for some a in A^{q+1} . This a is easily checked to be closed. $d^*[c]$ is defined to be the cohomology class $[a]$ in $H^{q+1}(A)$. A simple diagram-chasing shows that this definition of d^* is independent of the choices made.

Exercise. Show that the long exact sequence of cohomology groups exists and is exact. (If you are stuck, see, for instance, MacLane [1, Ch. II, Th. 4.1, p. 45].)

Compact Supports

A slight modification of the construction of the preceding section will give us another diffeomorphism invariant of a manifold. For now we again

restrict our attention to \mathbb{R}^n . Recall that the support of a continuous function f on a topological space X is the smallest closed set on which f is not zero, i.e., $\text{Supp } f = \{p \in X \mid f(p) \neq 0\}$. If in the definition of the de Rham complex we use only the C^∞ functions with compact support, the resulting complex is called the de Rham complex $\Omega_c^*(\mathbb{R}^n)$ with compact supports:

$$\Omega_c^*(\mathbb{R}^n) = \{C^\infty \text{ functions on } \mathbb{R}^n \text{ with compact support}\} \otimes_{\mathbb{R}} \Omega^*.$$

The cohomology of this complex is denoted by $H_c^*(\mathbb{R}^n)$.

EXAMPLE 1.6.

$$(a) H_c^*(\text{point}) = \begin{cases} \mathbb{R} & \text{in dimension 0,} \\ 0 & \text{elsewhere.} \end{cases}$$

(b) *The compact cohomology of \mathbb{R}^1 .* Again the closed 0-forms are the constant functions. Since there are no constant functions on \mathbb{R}^1 with compact support,

$$H_c^0(\mathbb{R}^1) = 0.$$

To compute $H_c^1(\mathbb{R}^1)$, consider the integration map

$$\int_{\mathbb{R}^1} : \Omega_c^1(\mathbb{R}^1) \longrightarrow \mathbb{R}^1.$$

This map is clearly surjective. It vanishes on the exact 1-forms df where f has compact support, for if the support of f lies in the interior of $[a, b]$, then

$$\int_{\mathbb{R}^1} \frac{df}{dx} dx = \int_a^b \frac{df}{dx} dx = f(b) - f(a) = 0.$$

If $g(x) dx \in \Omega_c^1(\mathbb{R}^1)$ is in the kernel of the integration map, then the function

$$f(x) = \int_{-\infty}^x g(u) du$$

will have compact support and $df = g(x) dx$. Hence the kernel of $\int_{\mathbb{R}^1}$ are precisely the exact forms and

$$H_c^1(\mathbb{R}^1) = \frac{\Omega_c^1(\mathbb{R}^1)}{\ker \int_{\mathbb{R}^1}} = \mathbb{R}^1.$$

REMARK. If $g(x) dx \in \Omega_c^1(\mathbb{R}^1)$ does not have total integral 0, then

$$f(x) = \int_{-\infty}^x g(u) du$$

will not have compact support and $g(x) dx$ will not be exact.

(c) More generally,

$$H_c^*(\mathbb{R}^n) = \begin{cases} \mathbb{R} & \text{in dimension } n \\ 0 & \text{otherwise.} \end{cases}$$

This result is the *Poincaré lemma for cohomology with compact support* and will be proved in Section 4.

Exercise 1.7. Compute $H_{DR}^*(\mathbb{R}^2 - P - Q)$ where P and Q are two points in \mathbb{R}^2 . Find the closed forms that represent the cohomology classes.

§2 The Mayer-Vietoris Sequence

In this section we extend the definition of the de Rham cohomology from \mathbb{R}^n to any differentiable manifold and introduce a basic technique for computing the de Rham cohomology, the Mayer-Vietoris sequence. But first we have to discuss the functorial nature of the de Rham complex.

The Functor Ω^*

Let x_1, \dots, x_m and y_1, \dots, y_n be the standard coordinates on \mathbb{R}^m and \mathbb{R}^n respectively. A smooth map $f: \mathbb{R}^m \rightarrow \mathbb{R}^n$ induces a pullback map on C^∞ functions $f^*: \Omega^0(\mathbb{R}^n) \rightarrow \Omega^0(\mathbb{R}^m)$ via

$$f^*(g) = g \circ f.$$

We would like to extend this pullback map to all forms $f^*: \Omega^*(\mathbb{R}^n) \rightarrow \Omega^*(\mathbb{R}^m)$ in such a way that it commutes with d . The commutativity with d defines f^* uniquely:

$$f^*(\sum g_i dy_{i_1} \dots dy_{i_r}) = \sum (g_i \circ f) df_{i_1} \dots df_{i_r},$$

where $f_i = y_i \circ f$ is the i -th component of the function f .

Proposition 2.1. *With the above definition of the pullback map f^* on forms, f^* commutes with d .*

PROOF. The proof is essentially an application of the chain rule.

$$df^*(g_i dy_{i_1} \dots dy_{i_r}) = d((g_i \circ f) df_{i_1} \dots df_{i_r}) = d(g_i \circ f) df_{i_1} \dots df_{i_r}.$$

$$f^*d(g_i dy_{i_1} \dots dy_{i_r}) = f^*\left(\frac{\partial g_i}{\partial y_i} dy_i dy_{i_1} \dots dy_{i_r}\right)$$

$$= \left(\left(\frac{\partial g_i}{\partial y_i} \circ f\right) df_i\right) df_{i_1} \dots df_{i_r}$$

$$= d(g_i \circ f) df_{i_1} \dots df_{i_r} \quad \square$$

Let x_1, \dots, x_n be the standard coordinate system and u_1, \dots, u_n a new coordinate system on \mathbb{R}^n , i.e., there is a diffeomorphism $f: \mathbb{R}^n \rightarrow \mathbb{R}^n$ such that $u_i = x_i \circ f = f^*(x_i)$. By the chain rule, if g is a smooth function on \mathbb{R}^n , then

$$\sum_i \frac{\partial g}{\partial u_i} du_i = \sum_{i,j} \frac{\partial g}{\partial u_i} \frac{\partial u_i}{\partial x_j} dx_j = \sum_j \frac{\partial g}{\partial x_j} dx_j.$$

So dg is independent of the coordinate system.

Exercise 2.1.1. More generally show that if $\omega = \sum g_I du_I$, then $d\omega = \sum dg_I du_I$.

Thus the exterior derivative d is independent of the coordinate system on \mathbb{R}^n .

Recall that a *category* consists of a class of *objects* and for any two objects A and B , a set $\text{Hom}(A, B)$ of *morphisms* from A to B , satisfying the following properties. If f is a morphism from A to B and g a morphism from B to C , then the *composite morphism* $g \circ f$ from A to C is defined; furthermore, the composition operation is required to be associative and to have an identity 1_A in $\text{Hom}(A, A)$ for every object A . The class of all groups together with the group homomorphisms is an example of a category.

A *covariant functor* F from a category \mathcal{X} to a category \mathcal{Y} associates to every object A in \mathcal{X} an object $F(A)$ in \mathcal{Y} , and every morphism $f: A \rightarrow B$ in \mathcal{X} a morphism $F(f): F(A) \rightarrow F(B)$ in \mathcal{Y} such that F preserves composition and the identity:

$$F(g \circ f) = F(g) \circ F(f)$$

$$F(1_A) = 1_{F(A)}.$$

If F reverses the arrows, i.e., $F(f): F(B) \rightarrow F(A)$, it is said to be a *contravariant functor*.

In this fancier language the discussion above may be summarized as follows: Ω^* is a *contravariant functor* from the category of Euclidean spaces $\{\mathbb{R}^n\}_{n \in \mathbb{Z}}$ and smooth maps: $\mathbb{R}^m \rightarrow \mathbb{R}^n$ to the category of commutative differential graded algebras and their homomorphisms. It is the unique such functor that is the pullback of functions on $\Omega^0(\mathbb{R}^n)$. Here the commutativity of the graded algebra refers to the fact that

$$\tau\omega = (-1)^{\deg \tau \deg \omega} \omega\tau.$$

The functor Ω^* may be extended to the category of differentiable manifolds. For the fundamentals of manifold theory we recommend de Rham [1, Chap. I]. Recall that a *differentiable structure* on a manifold is given by an *atlas*, i.e., an open cover $\{U_\alpha\}_{\alpha \in A}$ of M in which each open set U_α is homeomorphic to \mathbb{R}^n via a homeomorphism $\phi_\alpha: U_\alpha \xrightarrow{\sim} \mathbb{R}^n$, and on the overlaps $U_\alpha \cap U_\beta$ the transition functions

$$g_{\alpha\beta} = \phi_\alpha \circ \phi_\beta^{-1}: \phi_\beta(U_\alpha \cap U_\beta) \rightarrow \phi_\alpha(U_\alpha \cap U_\beta)$$

are diffeomorphisms of open subsets of \mathbb{R}^n ; furthermore, the atlas is required to be maximal with respect to inclusions. All manifolds will be assumed to be Hausdorff and to have a countable basis. The collection $\{(U_\alpha, \phi_\alpha)\}_{\alpha \in I}$ is called a *coordinate open cover* of M and ϕ_α is the *trivialization* of U_α . Let u_1, \dots, u_n be the standard coordinates on \mathbb{R}^n . We can write $\phi_\alpha = (x_1, \dots, x_n)$, where $x_i = u_i \circ \phi_\alpha$ are a coordinate system on U_α . A function f on U_α is *differentiable* if $f \circ \phi_\alpha^{-1}$ is a differentiable function on \mathbb{R}^n . If f is a differentiable function on U_α , the partial derivative $\partial f / \partial x_i$ is defined to be the i -th partial of the pullback function $f \circ \phi_\alpha^{-1}$ on \mathbb{R}^n :

$$\frac{\partial f}{\partial x_i}(p) = \frac{\partial (f \circ \phi_\alpha^{-1})}{\partial u_i}(\phi_\alpha(p)).$$

The *tangent space* to M at p , written $T_p M$, is the vector space over \mathbb{R} spanned by the operators $\partial / \partial x_1(p), \dots, \partial / \partial x_n(p)$, and a smooth *vector field* on U_α is a linear combination $X_\alpha = \sum f_i \partial / \partial x_i$ where the f_i 's are smooth functions on U_α . Relative to another coordinate system (y_1, \dots, y_n) , $X_\alpha = \sum g_j \partial / \partial y_j$ where $\partial / \partial x_i$ and $\partial / \partial y_j$ satisfy the *chain rule*:

$$\frac{\partial}{\partial x_i} = \sum \frac{\partial y_j}{\partial x_i} \frac{\partial}{\partial y_j}.$$

A C^∞ vector field on M may be viewed as a collection of vector fields X_α on U_α which agree on the overlaps $U_\alpha \cap U_\beta$.

A *differential form* ω on M is a collection of forms ω_U for U in the atlas defining M , which are compatible in the following sense: if i and j are the inclusions

$$\begin{array}{ccc} U \cap V & \xrightarrow{i} & U \\ & \searrow j & \\ & & V \end{array}$$

then $i^* \omega_U = j^* \omega_V$ in $\Omega^*(U \cap V)$. By the functoriality of Ω^* , the exterior derivative and the wedge product extend to differential forms on a manifold. Just as for \mathbb{R}^n a smooth map of differentiable manifolds $f: M \rightarrow N$ induces in a natural way a pullback map on forms $f^*: \Omega^*(N) \rightarrow \Omega^*(M)$. In this way Ω^* becomes a contravariant functor on the category of differentiable manifolds.

A *partition of unity* on a manifold M is a collection of non-negative C^∞ functions $\{\rho_\alpha\}_{\alpha \in I}$ such that

- (a) Every point has a neighborhood in which $\sum \rho_\alpha$ is a finite sum.
- (b) $\sum \rho_\alpha = 1$.

The basic technical tool in the theory of differentiable manifolds is the existence of a partition of unity. This result assumes two forms:

- (1) Given an open cover $\{U_\alpha\}_{\alpha \in I}$ of M , there is a partition of unity $\{\rho_\alpha\}_{\alpha \in I}$ such that the support of ρ_α is contained in U_α . We say in this case that $\{\rho_\alpha\}$ is a partition of unity *subordinate* to the open cover $\{U_\alpha\}$.

- (2) Given an open cover $\{U_\alpha\}_{\alpha \in I}$ of M , there is a partition of unity $\{\rho_\beta\}_{\beta \in J}$ with compact support, but possibly with an index set J different from I , such that the support of ρ_β is contained in some U_α .

For a proof see Warner [1, p. 10] or de Rham [1, p. 3].

Note that in (1) the support of ρ_α is not assumed to be compact and the index set of $\{\rho_\alpha\}$ is the same as that of $\{U_\alpha\}$, while in (2) the reverse is true. We usually cannot demand simultaneously compact support and the same index set on a noncompact manifold M . For example, consider the open cover of \mathbb{R}^1 consisting of precisely one open set, namely \mathbb{R}^1 itself. This open cover clearly does not have a partition of unity with compact support subordinate to it.

The Mayer-Vietoris Sequence

The Mayer-Vietoris sequence allows one to compute the cohomology of the union of two open sets. Suppose $M = U \cup V$ with U, V open. Then there is a sequence of inclusions

$$M \leftarrow U \amalg V \begin{array}{c} \xrightarrow{\partial_0} \\ \xrightarrow{\partial_1} \end{array} U \cap V$$

where $U \amalg V$ is the disjoint union of U and V and ∂_0 and ∂_1 are the inclusions of $U \cap V$ in V and in U respectively. Applying the contravariant functor Ω^* , we get a sequence of restrictions of forms

$$\Omega^*(M) \rightarrow \Omega^*(U) \oplus \Omega^*(V) \begin{array}{c} \xrightarrow{\partial_0^*} \\ \xrightarrow{\partial_1^*} \end{array} \Omega^*(U \cap V),$$

where by the restriction of a form to a submanifold we mean its image under the pullback map induced by the inclusion. By taking the difference of the last two maps, we obtain the *Mayer-Vietoris sequence*

$$(2.2) \quad 0 \rightarrow \Omega^*(M) \rightarrow \Omega^*(U) \oplus \Omega^*(V) \rightarrow \Omega^*(U \cap V) \rightarrow 0$$

$$(\omega, \tau) \mapsto \tau - \omega$$

Proposition 2.3. *The Mayer-Vietoris sequence is exact.*

PROOF. The exactness is clear except at the last step. We first consider the case of functions on $M = \mathbb{R}^1$. Let f be a C^∞ function on $U \cap V$ as shown in Figure 2.1. We must write f as the difference of a function on U and a function on V . Let $\{\rho_U, \rho_V\}$ be a partition of unity subordinate to the open cover $\{U, V\}$. Note that $\rho_V f$ is a function on U —to get a function on an open set we must multiply by the partition function of the other open set. Since

$$(\rho_U f) - (-\rho_V f) = f,$$

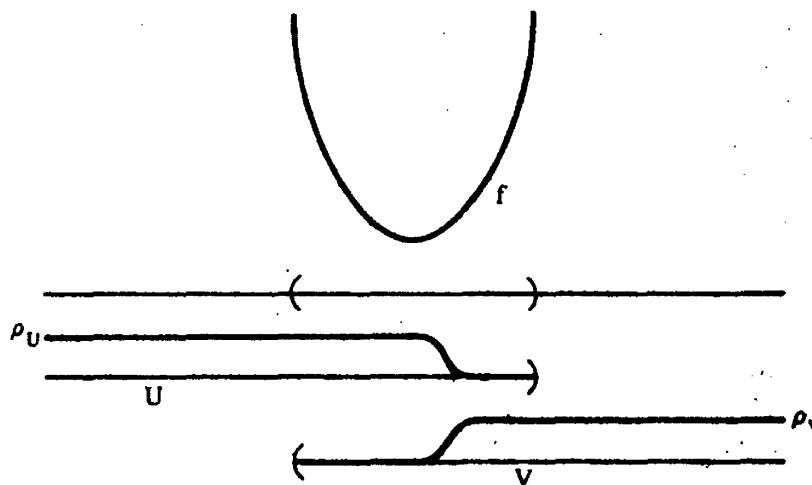

Figure 2.1

we see that $\Omega^0(U) \oplus \Omega^0(V) \rightarrow \Omega^0(\mathbb{R}^1) \rightarrow 0$ is surjective. For a general manifold M , if $\omega \in \Omega^q(U \cap V)$, then $(-\rho_V \omega, \rho_U \omega)$ in $\Omega^q(U) \oplus \Omega^q(V)$ maps onto ω . \square

The Mayer-Vietoris sequence

$$0 \rightarrow \Omega^*(M) \rightarrow \Omega^*(U) \oplus \Omega^*(V) \rightarrow \Omega^*(U \cap V) \rightarrow 0$$

induces a long exact sequence in cohomology, also called a Mayer-Vietoris sequence:

$$(2.4) \quad \begin{array}{ccccccc} \hookrightarrow & H^{q+1}(M) & \rightarrow & H^{q+1}(U) \oplus H^{q+1}(V) & \rightarrow & H^{q+1}(U \cap V) & \hookrightarrow \\ & & & \searrow d^* & & & \\ \hookrightarrow & H^q(M) & \rightarrow & H^q(U) \oplus H^q(V) & \rightarrow & H^q(U \cap V) & \hookrightarrow \end{array}$$

We recall again the definition of the coboundary operator d^* in this explicit instance. The short exact sequence gives rise to a diagram with exact rows

$$\begin{array}{ccccccc} & \uparrow & & \uparrow & & \uparrow & \\ 0 & \rightarrow & \Omega^{q+1}(M) & \rightarrow & \Omega^{q+1}(U) \oplus \Omega^{q+1}(V) & \rightarrow & \Omega^{q+1}(U \cap V) \rightarrow 0 \\ & & d\uparrow & & d\uparrow & & d\uparrow \\ 0 & \rightarrow & \Omega^q(M) & \rightarrow & \Omega^q(U) \oplus \Omega^q(V) & \rightarrow & \Omega^q(U \cap V) \rightarrow 0 \\ & & & & \omega & & \omega \\ & & & & \zeta & & \omega \quad d\omega = 0 \end{array}$$

Let $\omega \in \Omega^q(U \cap V)$ be a closed form. By the exactness of the rows, there is a $\xi \in \Omega^q(U) \oplus \Omega^q(V)$ which maps to ω , namely, $\xi = (-\rho_V \omega, \rho_U \omega)$. By the

commutativity of the diagram and the fact that $d\omega = 0$, $d\xi$ goes to 0 in $\Omega^{q+1}(U \cap V)$, i.e., $-d(\rho_V \omega)$ and $d(\rho_U \omega)$ agree on the overlap $U \cap V$. Hence $d\xi$ is the image of an element in $\Omega^{q+1}(M)$. This element is easily seen to be closed and represents $d^*[\omega]$. As remarked earlier, it can be shown that $d^*[\omega]$ is independent of the choices in this construction. Explicitly we see that the coboundary operator is given by

$$(2.5) \quad d^*[\omega] = \begin{cases} [-d(\rho_V \omega)] & \text{on } U \\ [d(\rho_U \omega)] & \text{on } V. \end{cases}$$

We define the *support* of a form ω on a manifold M to be the smallest closed set Z so that ω restricted to Z is not 0. Note that in the Mayer-Vietoris sequence $d^*\omega \in H^*(M)$ has support in $U \cap V$.

EXAMPLE 2.6 (The cohomology of the circle). Cover the circle with two open sets U and V as shown in Figure 2.2. The Mayer-Vietoris sequence gives

$$\begin{array}{ccccccc}
 & & S^1 & & U \sqcup V & & U \cap V \\
 H^2 & & 0 & & 0 & & 0 \\
 \curvearrowright H^1 & & \longrightarrow & & 0 & \longrightarrow & 0 \\
 & & & & d^* & & \\
 H^0 & & \longrightarrow & & \mathbb{R} \oplus \mathbb{R} & \xrightarrow{\delta} & \mathbb{R} \oplus \mathbb{R} \curvearrowright
 \end{array}$$

The difference map δ sends (ω, τ) to $(\tau - \omega, \tau - \omega)$, so $\text{im } \delta$ is 1-dimensional. It follows that $\ker \delta$ is also 1-dimensional. Therefore,

$$H^0(S^1) = \ker \delta = \mathbb{R}$$

$$H^1(S^1) = \text{coker } \delta = \mathbb{R}.$$

We now find an explicit representative for the generator of $H^1(S^1)$. If $\alpha \in \Omega^0(U \cap V)$ is a closed 0-form which is not the image under δ of a closed form in $\Omega^0(U) \oplus \Omega^0(V)$, then $d^*\alpha$ will represent a generator of $H^1(S^1)$. As α we may take the function which is 1 on the upper piece of $U \cap V$ and 0 on

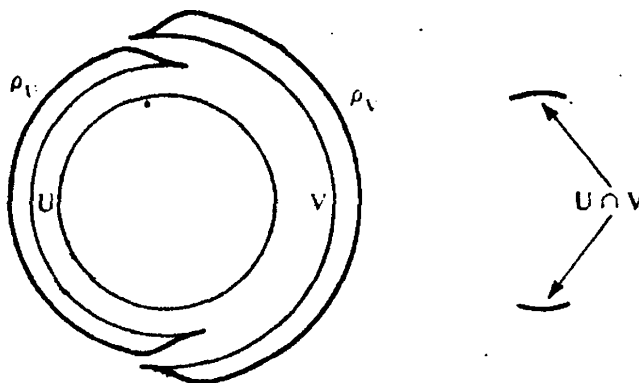

Figure 2.2

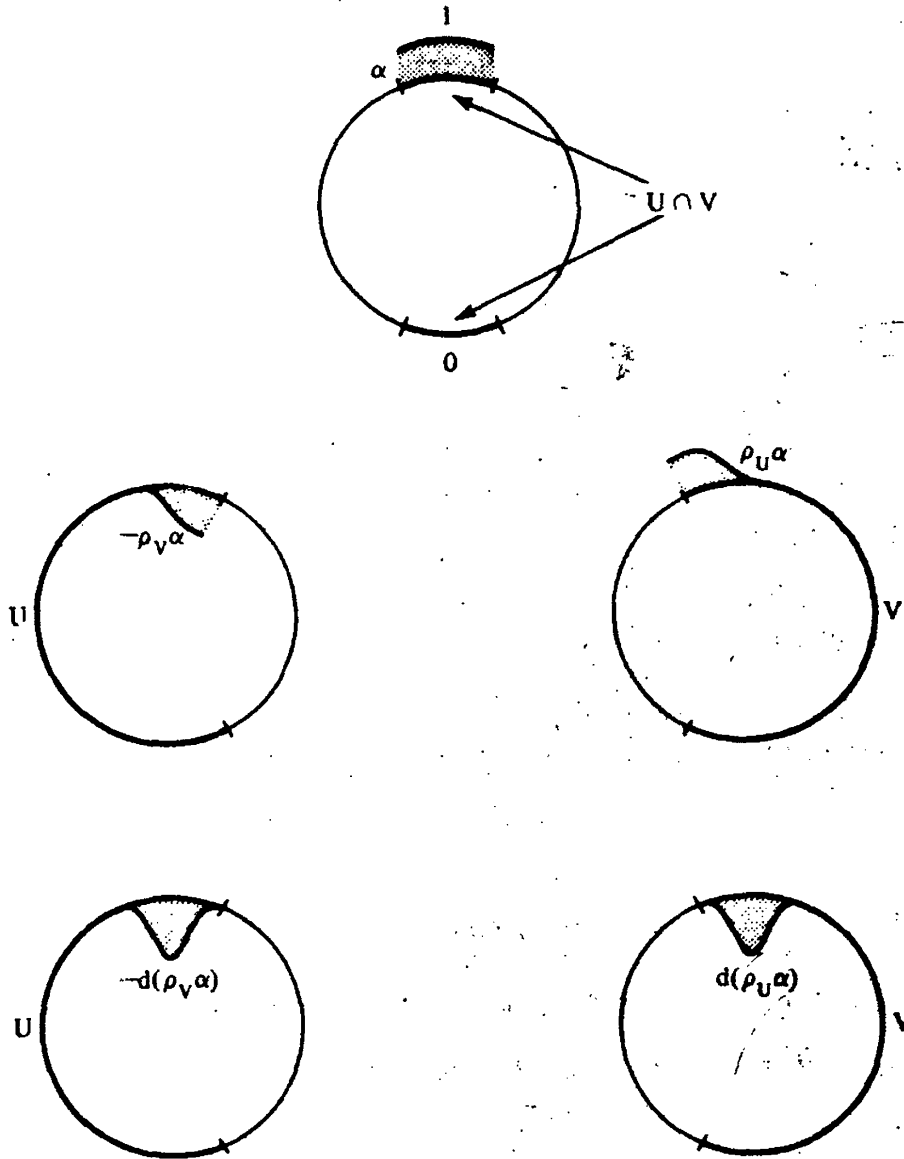

Figure 2.3

the lower piece (see Figure 2.3). Now α is the image of $(-\rho_V \alpha, \rho_U \alpha)$. Since $-d(\rho_V \alpha)$ and $d(\rho_U \alpha)$ agree on $U \cap V$, they represent a global form on S^1 ; this form is $d^* \alpha$. It is a bump 1-form with support in $U \cap V$.

The Functor Ω_c^* and the Mayer-Vietoris Sequence for Compact Supports

Again, before taking up the Mayer-Vietoris sequence for compactly supported cohomology, we need to discuss the functorial properties of $\Omega_c^*(M)$, the algebra of forms with compact support on the manifold M . In general the pullback by a smooth map of a form with compact support need not

have compact support; for example, consider the pullback of functions under the projection $M \times \mathbb{R} \rightarrow M$. So Ω_c^* is not a functor on the category of manifolds and smooth maps. However if we consider not all smooth maps, but only an appropriate subset of smooth maps, then Ω_c^* can be made into a functor. There are two ways in which this can be done.

- (a) Ω_c^* is a *contravariant* functor under *proper maps*. (A map is *proper* if the inverse image of every compact set is compact.)
 (b) Ω_c^* is a *covariant* functor under *inclusions of open sets*.

If $j : U \rightarrow M$ is the inclusion of the open subset U in the manifold M , then $j_* : \Omega_c^*(U) \rightarrow \Omega_c^*(M)$ is the map which extends a form on U by zero to a form on M .

It is the covariant nature of Ω_c^* which we shall exploit to prove Poincaré duality for noncompact manifolds. So from now on we assume that Ω_c^* refers to the covariant functor in (b). There is also a Mayer-Vietoris sequence for this functor. As before, let M be covered by two open sets U and V . The sequence of inclusions

$$M \leftarrow U \amalg V \leftarrow U \cap V$$

gives rise to a sequence of forms with compact support

$$\begin{array}{ccccc} \Omega_c^*(M) & \xleftarrow{\text{sum}} & \Omega_c^*(U) \oplus \Omega_c^*(V) & \xleftarrow[\text{inclusion}]{\delta} & \Omega_c^*(U \cap V) \\ & & & & \\ & & (-j_*\omega, j_*\omega) & \xleftarrow{\quad} & \omega \end{array}$$

Proposition 2.7. *The Mayer-Vietoris sequence of forms with compact support*

$$0 \leftarrow \Omega_c^*(M) \leftarrow \Omega_c^*(U) \oplus \Omega_c^*(V) \leftarrow \Omega_c^*(U \cap V) \leftarrow 0$$

is exact.

PROOF. This time exactness is easy to check at every step. We do it for the last step. Let ω be a form in $\Omega_c^*(M)$. Then ω is the image of $(\rho_U \omega, \rho_V \omega)$ in $\Omega_c^*(U) \oplus \Omega_c^*(V)$. The form $\rho_U \omega$ has compact support because $\text{Supp } \rho_U \omega \subset \text{Supp } \rho_U \cap \text{Supp } \omega$ and by a lemma from general topology, a closed subset of a compact set in a Hausdorff space is compact. This shows the surjectivity of the map $\Omega_c^*(U) \oplus \Omega_c^*(V) \rightarrow \Omega_c^*(M)$. Note that whereas in the previous Mayer-Vietoris sequence we multiply by ρ_V to get a form on U , here $\rho_U \omega$ is a form on U . \square

Again the Mayer-Vietoris sequence gives rise to a long exact sequence in cohomology:

$$(2.8) \quad \begin{array}{ccccccc} \hookrightarrow & H_c^{q+1}(M) & \leftarrow & H_c^{q+1}(U) \oplus H_c^{q+1}(V) & \leftarrow & H_c^{q+1}(U \cap V) & \hookrightarrow \\ & & & & & & \\ & & & d_* & & & \\ \hookrightarrow & H_c^q(M) & \leftarrow & H_c^q(U) \oplus H_c^q(V) & \leftarrow & H_c^q(U \cap V) & \hookrightarrow \end{array}$$

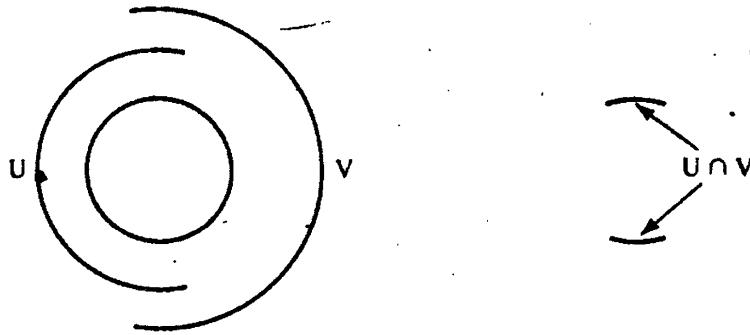

Figure 2.4

EXAMPLE 2.9 (The cohomology with compact support of the circle). Of course since S^1 is compact, the cohomology with compact support $H_c^*(S^1)$ should be the same as the ordinary de Rham cohomology $H^*(S^1)$. Nonetheless, as an illustration we will compute $H_c^*(S^1)$ from the Mayer-Vietoris sequence for compact supports:

$$\begin{array}{ccccccc}
 & S^1 & & U \sqcup V & & U \cap V & \\
 H_c^2 & & & 0 & & 0 & \leftarrow \\
 H_c^1 & \leftarrow & & \mathbb{R} \oplus \mathbb{R} & \xleftarrow{\delta} & \mathbb{R} \oplus \mathbb{R} & \leftarrow \\
 H_c^0 & \leftarrow & & 0 & \leftarrow & 0 & \leftarrow
 \end{array}$$

Here the map δ sends $\omega = (\omega_1, \omega_2) \in H_c^1(U \cap V)$ to $(-j_U)_*\omega, (j_V)_*\omega \in H_c^1(U) \oplus H_c^1(V)$, where j_U and j_V are the inclusions of $U \cap V$ in U and in V respectively. Since $\text{im } \delta$ is 1-dimensional,

$$H_c^0(S^1) = \ker \delta = \mathbb{R}$$

$$H_c^1(S^1) = \text{coker } \delta = \mathbb{R}.$$

§3 Orientation and Integration

Orientation and the Integral of a Differential Form

Let x_1, \dots, x_n be the standard coordinates on \mathbb{R}^n . Recall that the Riemann integral of a differentiable function f with compact support is

$$\int_{\mathbb{R}^n} |f| dx_1 \dots dx_n = \lim_{\Delta x_i \rightarrow 0} \sum f \Delta x_1 \dots \Delta x_n.$$

We define the integral of an n -form with compact support $\omega = f dx_1 \dots dx_n$ to be the Riemann integral $\int_{\mathbb{R}^n} |f| dx_1 \dots dx_n$. Note that contrary to the usual calculus notation we put an absolute value sign in the Riemann

integral; this is to emphasize the distinction between the Riemann integral of a function and the integral of a differential form. While the order of x_1, \dots, x_n matters in a differential form, it does not in a Riemann integral; if π is a permutation of $\{1, \dots, n\}$, then

$$\int f dx_{\pi(1)} \dots dx_{\pi(n)} = (\text{sgn } \pi) \int f |dx_1 \dots dx_n|,$$

but

$$\int f |dx_{\pi(1)} \dots dx_{\pi(n)}| = \int f |dx_1 \dots dx_n|.$$

In a situation where there is no possibility of confusion, we may revert to the usual calculus notation.

So defined, the integral of an n -form on \mathbb{R}^n depends on the coordinates x_1, \dots, x_n . From our point of view a change of coordinates is given by a diffeomorphism $T: \mathbb{R}^n \rightarrow \mathbb{R}^n$ with coordinates y_1, \dots, y_n and x_1, \dots, x_n respectively:

$$x_i = x_i \circ T(y_1, \dots, y_n) = T_i(y_1, \dots, y_n).$$

We now study how the integral $\int \omega$ transforms under such diffeomorphisms.

Exercise 3.1. Show that $dT_1 \dots dT_n = J(T) dy_1 \dots dy_n$, where $J(T) = \det(\partial x_i / \partial y_j)$ is the Jacobian determinant of T .

Hence,

$$\int_{\mathbb{R}^n} T^* \omega = \int_{\mathbb{R}^n} (f \circ T) dT_1 \dots dT_n = \int_{\mathbb{R}^n} (f \circ T) J(T) dy_1 \dots dy_n$$

relative to the coordinate system y_1, \dots, y_n . On the other hand, by the change of variables formula,

$$\int_{\mathbb{R}^n} \omega = \int_{\mathbb{R}^n} f(x_1, \dots, x_n) dx_1 \dots dx_n = \int_{\mathbb{R}^n} (f \circ T) |J(T)| dy_1 \dots dy_n,$$

Thus

$$\int_{\mathbb{R}^n} T^* \omega = \pm \int_{\mathbb{R}^n} \omega$$

depending on whether the Jacobian determinant is positive or negative. In general if T is a diffeomorphism of open subsets of \mathbb{R}^n and if the Jacobian determinant $J(T)$ is everywhere positive, then T is said to be *orientation-preserving*. The integral on \mathbb{R}^n is not invariant under the whole group of

diffeomorphisms of \mathbb{R}^n , but only under the subgroup of orientation-preserving diffeomorphisms.

Let M be a differentiable manifold with atlas $\{(U_\alpha, \phi_\alpha)\}$. We say that the atlas is *oriented* if all the transition functions $\theta_{\alpha\beta} = \phi_\alpha \circ \phi_\beta^{-1}$ are orientation-preserving, and that the manifold is *orientable* if it has an oriented atlas.

Proposition 3.2. *A manifold M of dimension n is orientable if and only if it has a global nowhere vanishing n -form.*

PROOF. Observe that $T: \mathbb{R}^n \rightarrow \mathbb{R}^n$ is orientation-preserving if and only if $T^* dx_1 \dots dx_n$ is a positive multiple of $dx_1 \dots dx_n$ at every point.

(\Leftarrow) Suppose M has a global nowhere-vanishing n -form ω . Let $\phi_\alpha: U_\alpha \xrightarrow{\cong} \mathbb{R}^n$ be a coordinate map. Then $\phi_\alpha^* dx_1 \dots dx_n = f_\alpha \omega$ where f_α is a nowhere-vanishing real-valued function on U_α . Thus f_α is either everywhere positive or everywhere negative. In the latter case interchange x_1 and x_2 . Since $\phi_\alpha^* dx_2 dx_1 dx_3 \dots dx_n = -\phi_\alpha^* dx_1 dx_2 dx_3 \dots dx_n = (-f_\alpha)\omega$, we may assume f_α to be positive for all α . Hence, any transition function $\phi_\beta \phi_\alpha^{-1}: \mathbb{R}^n \rightarrow \mathbb{R}^n$ will pull $dx_1 \dots dx_n$ to a positive multiple of itself. So $\{(U_\alpha, \phi_\alpha)\}$ is an oriented atlas.

(\Rightarrow) Conversely, suppose M has an oriented atlas $\{(U_\alpha, \phi_\alpha)\}$. Then

$$(\phi_\beta \phi_\alpha^{-1})^* (dx_1 \dots dx_n) = \lambda dx_1 \dots dx_n$$

for some positive function λ . Thus

$$\phi_\beta^* dx_1 \dots dx_n = (\phi_\alpha^* \lambda)(\phi_\alpha^* dx_1 \dots dx_n).$$

Denoting $\phi_\alpha^* dx_1 \dots dx_n$ by ω_α , we see that $\omega_\beta = f \omega_\alpha$ where $f = \phi_\alpha^* \lambda = \lambda \circ \phi_\alpha$ is a positive function on $U_\alpha \cap U_\beta$.

Let $\omega = \sum \rho_\alpha \omega_\alpha$ where ρ_α is a partition of unity subordinate to the open cover $\{U_\alpha\}$. At each point p in M , all the forms ω_α , if defined, are positive multiples of one another. Since $\rho_\alpha \geq 0$ and not all ρ_α can vanish at a point, ω is nowhere vanishing. \square

Any two global nowhere vanishing n -forms ω and ω' on an orientable manifold M of dimension n differ by a nowhere vanishing function: $\omega = f\omega'$. If M is connected, then f is either everywhere positive or everywhere negative. We say that ω and ω' are *equivalent* if f is positive. Thus on a connected orientable manifold M the nowhere vanishing n -forms fall into two equivalence classes. Either class is called an *orientation* on M , written $[M]$. For example, the standard orientation on \mathbb{R}^n is given by $dx_1 \dots dx_n$.

Now choose an orientation $[M]$ on M . Given a top form τ in $\Omega_c^n(M)$, we define its integral by

$$\int_{[M]} \tau = \sum_\alpha \int_{U_\alpha} \rho_\alpha \tau$$

where $\int_{U_\alpha} \rho_\alpha \tau$ means $\int_{\mathbb{R}^n} (\phi_\alpha^{-1})^* (\rho_\alpha \tau)$ for some orientation-preserving trivialization $\phi_\alpha : U_\alpha \xrightarrow{\sim} \mathbb{R}^n$; as in Proposition 2.7, $\rho_\alpha \tau$ has compact support. By the orientability assumption, the integral over a coordinate patch $\int_{U_\alpha} \omega$ is well defined. With a fixed orientation on M understood, we will often write $\int_M \tau$ instead of $\int_{[M]} \tau$. Reversing the orientation results in the negative of the integral.

Proposition 3.3. *The definition of the integral $\int_M \tau$ is independent of the oriented atlas $\{(U_\alpha, \phi_\alpha)\}$ and the partition of unity $\{\rho_\alpha\}$.*

PROOF. Let $\{V_\beta\}$ be another oriented atlas of M , and $\{\chi_\beta\}$ a partition of unity subordinate to $\{V_\beta\}$. Since $\sum_\beta \chi_\beta = 1$,

$$\sum_\alpha \int_{U_\alpha} \rho_\alpha \tau = \sum_{\alpha, \beta} \int_{U_\alpha} \rho_\alpha \chi_\beta \tau.$$

Now $\rho_\alpha \chi_\beta \tau$ has support in $U_\alpha \cap V_\beta$, so

$$\int_{U_\alpha} \rho_\alpha \chi_\beta \tau = \int_{V_\beta} \rho_\alpha \chi_\beta \tau.$$

Therefore

$$\sum_\alpha \int_{U_\alpha} \rho_\alpha \tau = \sum_{\alpha, \beta} \int_{V_\beta} \rho_\alpha \chi_\beta \tau = \sum_\beta \int_{V_\beta} \chi_\beta \tau. \quad \square$$

A manifold M of dimension n with boundary is given by an atlas $\{(U_\alpha, \phi_\alpha)\}$ where U_α is homeomorphic to either \mathbb{R}^n or the upper half space $\mathbb{H}^n = \{(x_1, \dots, x_n) \mid x_n \geq 0\}$. The boundary ∂M of M is an $(n-1)$ -dimensional manifold. An oriented atlas for M induces in a natural way an oriented atlas for ∂M . This is a consequence of the following lemma.

Lemma 3.4. *Let $T : \mathbb{H}^n \rightarrow \mathbb{H}^n$ be a diffeomorphism of the upper half space with everywhere positive Jacobian determinant. T induces a map \bar{T} of the boundary of \mathbb{H}^n to itself. The induced map \bar{T} , as a diffeomorphism of \mathbb{R}^{n-1} , also has positive Jacobian determinant everywhere.*

PROOF. By the inverse function theorem an interior point of \mathbb{H}^n must be the image of an interior point. Hence T maps the boundary to the boundary. We will check that \bar{T} has positive Jacobian determinant for $n=2$; the general case is similar.

Let T be given by

$$\begin{aligned} x_1 &= T_1(y_1, y_2) \\ x_2 &= T_2(y_1, y_2). \end{aligned}$$

Then \bar{T} is given by

$$x_1 = T_1(y_1, 0).$$

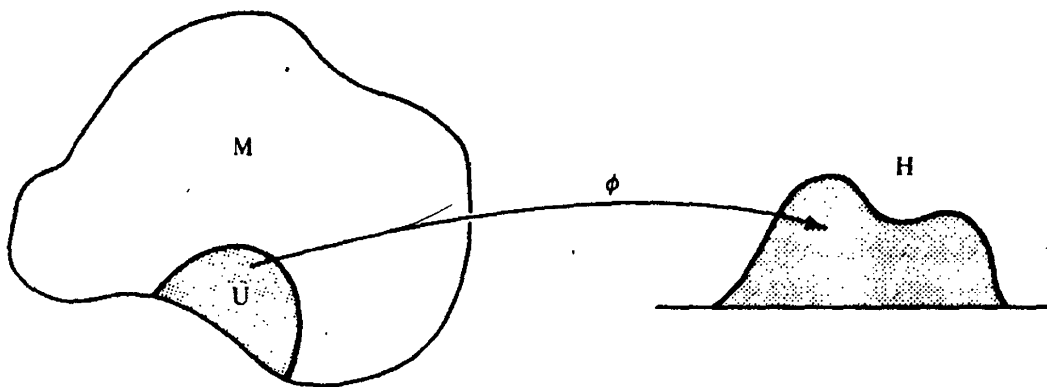

Figure 3.1

By assumption

$$\begin{vmatrix} \frac{\partial T_1}{\partial y_1}(y_1, 0) & \frac{\partial T_1}{\partial y_2}(y_1, 0) \\ \frac{\partial T_2}{\partial y_1}(y_1, 0) & \frac{\partial T_2}{\partial y_2}(y_1, 0) \end{vmatrix} > 0.$$

Since $0 = T_2(y_1, 0)$ for all y_1 , $\partial T_2 / \partial y_1(y_1, 0) = 0$; since T maps the upper half plane to itself,

$$\frac{\partial T_2}{\partial y_2}(y_1, 0) > 0.$$

Therefore

$$\frac{\partial T_1}{\partial y_1}(y_1, 0) > 0. \quad \square$$

Let the upper half space $H^n = \{x_n \geq 0\}$ in \mathbb{R}^n be given the standard orientation $dx_1 \dots dx_n$. Then the *induced orientation* on its boundary $\partial H^n = \{x_n = 0\}$ is by definition the equivalence class of $(-1)^n dx_1 \dots dx_{n-1}$; this sign is needed to make Stokes' theorem sign-free. In general for M an oriented manifold with boundary, we define the *induced orientation* $[\partial M]$ on ∂M by the following requirement: if ϕ is an orientation-preserving diffeomorphism of some open set U in M into the upper half space H^n , then

$$\phi^*[\partial H^n] = [\partial M]|_{\partial U},$$

where $\partial U = (\partial M) \cap U$ (see Figure 3.1).

Stokes' Theorem

A basic result in the theory of integration is

Theorem 3.5 (Stokes' Theorem). *If ω is an $(n - 1)$ -form with compact support on an oriented manifold M of dimension n and if ∂M is given the induced*

orientation, then

$$\int_M d\omega = \int_{\partial M} \omega.$$

We first examine two special cases.

SPECIAL CASE 1 (\mathbb{R}^n). By the linearity of the integrand we may take ω to be $f dx_1 \dots dx_{n-1}$. Then $d\omega = \pm \partial f / \partial x_n dx_1 \dots dx_n$. By Fubini's theorem,

$$\int_{\mathbb{R}^n} d\omega = \pm \int \left(\int_{-\infty}^{\infty} \frac{\partial f}{\partial x_n} dx_n \right) dx_1 \dots dx_{n-1}.$$

But $\int_{-\infty}^{\infty} \partial f / \partial x_n dx_n = f(x_1, \dots, x_{n-1}, \infty) - f(x_1, \dots, x_{n-1}, -\infty) = 0$ because f has compact support. Since \mathbb{R}^n has no boundary, this proves Stokes' theorem for \mathbb{R}^n .

SPECIAL CASE 2 (The upper half plane). In this case (see Figure 3.2)

$$\omega = f(x, y) dx + g(x, y) dy$$

and

$$d\omega = \left(-\frac{\partial f}{\partial y} + \frac{\partial g}{\partial x} \right) dx dy.$$

Note that

$$\int_{\mathbb{H}^2} \frac{\partial g}{\partial x} dx dy = \int_0^{\infty} \left(\int_{-\infty}^{\infty} \frac{\partial g}{\partial x} dx \right) dy = \int g(\infty, y) - g(-\infty, y) dy = 0,$$

since g has compact support. Therefore,

$$\begin{aligned} \int_{\mathbb{H}^2} \omega &= - \int_{\mathbb{H}^2} \frac{\partial f}{\partial y} dx dy = - \int_{-\infty}^{\infty} \left(\int_0^{\infty} \frac{\partial f}{\partial y} dy \right) dx \\ &= - \int_{-\infty}^{\infty} (f(x, \infty) - f(x, 0)) dx \\ &= \int_{-\infty}^{\infty} f(x, 0) dx = \int_{\partial \mathbb{H}^2} \omega \end{aligned}$$

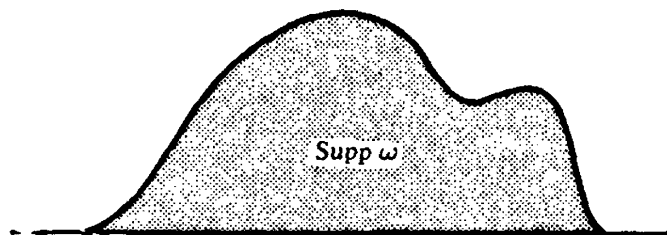

Figure 3.2

where the last equality holds because the restriction of $g(x, y)dy$ to $\partial\mathbb{H}^2$ is 0. So Stokes' theorem holds for the upper half plane.

The case of the upper half space in \mathbb{R}^n is entirely analogous.

Exercise 3.6. Prove Stokes' theorem for the upper half space.

We now consider the general case of a manifold of dimension n . Let $\{U_\alpha\}$ be an oriented atlas for M and $\{\rho_\alpha\}$ a partition of unity subordinate to $\{U_\alpha\}$. Write $\omega = \sum \rho_\alpha \omega$. Since Stokes' theorem $\int_M d\omega = \int_{\partial M} \omega$ is linear in ω , we need to prove it only for $\rho_\alpha \omega$, which has the virtue that its support is contained entirely in U_α . Furthermore, $\rho_\alpha \omega$ has compact support because

$$\text{Supp } \rho_\alpha \omega \subset \text{Supp } \rho_\alpha \cap \text{Supp } \omega$$

is a closed subset of a compact set. Since U_α is diffeomorphic to either \mathbb{R}^n or the upper half space \mathbb{H}^n , by the computations above Stokes' theorem holds for U_α . Consequently

$$\int_M d\rho_\alpha \omega = \int_{U_\alpha} d\rho_\alpha \omega = \int_{\partial U_\alpha} \rho_\alpha \omega = \int_{\partial M} \rho_\alpha \omega.$$

This concludes the proof of Stokes' theorem in general.

§4 Poincaré Lemmas

The Poincaré Lemma for de Rham Cohomology

In this section we compute the ordinary cohomology and the compactly supported cohomology of \mathbb{R}^n . Let $\pi: \mathbb{R}^n \times \mathbb{R}^1 \rightarrow \mathbb{R}^n$ be the projection on the first factor and $s: \mathbb{R}^n \rightarrow \mathbb{R}^n \times \mathbb{R}^1$ the zero section.

$$\begin{array}{ccc} \mathbb{R}^n \times \mathbb{R}^1 & \Omega^*(\mathbb{R}^n \times \mathbb{R}^1) & \\ \begin{array}{c} \uparrow \downarrow \\ s \quad \pi \end{array} & \begin{array}{c} \uparrow \downarrow \\ s^* \quad \pi^* \end{array} & \begin{array}{l} \pi(x, t) = x \\ s(x) = (x, 0) \end{array} \\ \mathbb{R}^n & \Omega^*(\mathbb{R}^n) & \end{array}$$

We will show that these maps induce inverse isomorphisms in cohomology and therefore $H^*(\mathbb{R}^{n+1}) \simeq H^*(\mathbb{R}^n)$. As a matter of convention all maps are assumed to be C^∞ unless otherwise specified.

Since $\pi \circ s = 1$, we have trivially $s^* \circ \pi^* = 1$. However $s \circ \pi \neq 1$ and correspondingly $\pi^* \circ s^* \neq 1$ on the level of forms. For example, $\pi^* \circ s^*$ sends the function $f(x, t)$ to $f(x, 0)$, a function which is constant along every fiber. To show that $\pi^* \circ s^*$ is the identity in cohomology, it is enough to find a map K on $\Omega^*(\mathbb{R}^n \times \mathbb{R}^1)$ such that

$$1 - \pi^* \circ s^* = \pm(dK \pm Kd),$$

for $dK \pm Kd$ maps closed forms to exact forms and therefore induces zero in cohomology. Such a K is called a *homotopy operator*; if it exists, we say that $\pi^* \circ s^*$ is *chain homotopic* to the identity. Note that the homotopy operator K decreases the degree by 1.

Every form on $\mathbb{R}^n \times \mathbb{R}$ is uniquely a linear combination of the following two types of forms:

$$\begin{aligned} \text{(I)} & (\pi^* \phi) f(x, t), \\ \text{(II)} & (\pi^* \phi) f(x, t) dt, \end{aligned}$$

where ϕ is a form on the base \mathbb{R}^n . We define $K : \Omega^q(\mathbb{R}^n \times \mathbb{R}) \rightarrow \Omega^{q-1}(\mathbb{R}^n \times \mathbb{R})$ by

$$\begin{aligned} \text{(I)} & (\pi^* \phi) f(x, t) \mapsto 0, \\ \text{(II)} & (\pi^* \phi) f(x, t) dt \mapsto (\pi^* \phi) \int_0^t f. \end{aligned}$$

Let's check that K is indeed a homotopy operator. We will use the simplified notation $\partial f / \partial x$ for $\sum \partial f / \partial x_i dx_i$, and $\int g$ for $\int g(x, t) dt$. On forms of type (I),

$$\begin{aligned} \omega &= (\pi^* \phi) \cdot f(x, t), \quad \deg \omega = q, \\ (1 - \pi^* s^*) \omega &= (\pi^* \phi) \cdot f(x, t) - \pi^* \phi \cdot f(x, 0), \\ (dK - Kd) \omega &= -Kd\omega = -K \left((d\pi^* \phi) f + (-1)^q \pi^* \phi \left(\frac{\partial f}{\partial x} dx + \frac{\partial f}{\partial t} dt \right) \right) \\ &= (-1)^{q-1} \pi^* \phi \int_0^t \frac{\partial f}{\partial t} = (-1)^{q-1} \pi^* \phi [f(x, t) - f(x, 0)]. \end{aligned}$$

Thus,

$$1 - \pi^* s^* = (-1)^{q-1} (dK - Kd).$$

On forms of type (II),

$$\begin{aligned} \omega &= (\pi^* \phi) f dt, \quad \deg \omega = q, \\ d\omega &= (\pi^* d\phi) f dt + (-1)^{q-1} (\pi^* \phi) \frac{\partial f}{\partial x} dx dt, \\ (1 - \pi^* s^*) \omega &= \omega \text{ because } s^*(dt) = d(s^*t) = d(0) = 0, \\ Kd\omega &= (\pi^* d\phi) \int_0^t f + (-1)^{q-1} (\pi^* \phi) dx \int_0^t \frac{\partial f}{\partial x}, \\ dK\omega &= (\pi^* d\phi) \int_0^t f + (-1)^{q-1} (\pi^* \phi) \left[dx \left(\int_0^t \frac{\partial f}{\partial x} \right) + f dt \right]. \end{aligned}$$

Thus

$$(dK - Kd) \omega = (-1)^{q-1} \omega.$$

In either case,

$$1 - \pi^* \circ s^* = (-1)^{q-1}(dK - Kd) \quad \text{on } \Omega^q(\mathbb{R}^n \times \mathbb{R}).$$

This proves

Proposition 4.1. *The maps $H^*(\mathbb{R}^n \times \mathbb{R}^1) \xrightarrow{\pi^*} H^*(\mathbb{R}^n)$ are isomorphisms.*

By induction, we obtain the cohomology of \mathbb{R}^n .

Corollary 4.1.1 (Poincaré Lemma).

$$H^*(\mathbb{R}^n) = H^*(\text{point}) = \begin{cases} \mathbb{R} & \text{in dimension 0} \\ 0 & \text{elsewhere.} \end{cases}$$

Consider more generally

$$\begin{array}{ccc} M \times \mathbb{R}^1 & & \\ \pi \downarrow & \uparrow s & \\ M & & \end{array}$$

If $\{U_\alpha\}$ is an atlas for M , then $\{U_\alpha \times \mathbb{R}^1\}$ is an atlas for $M \times \mathbb{R}^1$. Again every form on $M \times \mathbb{R}^1$ is a linear combination of the two types of forms (I) and (II). We can define the homotopy operator K as before and the proof carries over word for word to show that $H^*(M \times \mathbb{R}^1) \simeq H^*(M)$ is an isomorphism via π^* and s^* .

Corollary 4.1.2 (Homotopy Axiom for de Rham Cohomology). *Homotopic maps induce the same map in cohomology.*

PROOF. Recall that a *homotopy* between two maps f and g from M to N is a map $F : M \times \mathbb{R}^1 \rightarrow N$ such that

$$\begin{cases} F(x, t) = f(x) & \text{for } t \geq 1 \\ F(x, t) = g(x) & \text{for } t \leq 0. \end{cases}$$

Equivalently if s_0 and $s_1 : M \rightarrow M \times \mathbb{R}^1$ are the 0-section and 1-section respectively, i.e., $s_1(x) = (x, 1)$, then

$$\begin{aligned} f &= F \circ s_1, \\ g &= F \circ s_0. \end{aligned}$$

Thus

$$\begin{aligned} f^* &= (F \circ s_1)^* = s_1^* \circ F^*, \\ g^* &= (F \circ s_0)^* = s_0^* \circ F^*. \end{aligned}$$

Since s_1^* and s_0^* both invert π^* , they are equal. Hence,

$$f^* = g^*.$$

□

Two manifolds M and N are said to have the same *homotopy type in the C^∞ sense* if there are C^∞ maps $f : M \rightarrow N$ and $g : N \rightarrow M$ such that $g \circ f$ and $f \circ g$ are C^∞ homotopic to the identity on M and N respectively. A manifold having the homotopy type of a point is said to be *contractible*.

Corollary 4.1.2.1. *Two manifolds with the same homotopy type have the same de Rham cohomology.*

If $i : A \hookrightarrow M$ is the inclusion and $r : M \rightarrow A$ is a map which restricts to the identity on A , then r is called a *retraction of M onto A* . Equivalently, $r \circ i : A \rightarrow A$ is the identity. If in addition $i \circ r : M \rightarrow M$ is *homotopic* to the identity on M , then r is said to be a *deformation retraction of M onto A* . In this case A and M have the same homotopy type.

Corollary 4.1.2.2. *If A is a deformation retract of M , then A and M have the same de Rham cohomology.*

Exercise 4.2. Show that $r : \mathbb{R}^2 - \{0\} \rightarrow S^1$ given by $r(x) = x/\|x\|$ is a deformation retraction.

Exercise 4.3. The cohomology of the n -sphere S^n . Cover S^n by two open sets U and V where U is slightly larger than the northern hemisphere and V slightly larger than the southern hemisphere (Figure 4.1). Then $U \cap V$ is diffeomorphic to $S^{n-1} \times \mathbb{R}^1$ where S^{n-1} is the equator. Using the Mayer-Vietoris sequence, show that

$$H^*(S^n) = \begin{cases} \mathbb{R} & \text{in dimensions } 0, n \\ 0 & \text{otherwise.} \end{cases}$$

We saw previously that a generator of $H^1(S^1)$ is a bump 1-form on S^1 which gives the isomorphism $H^1(S^1) \simeq \mathbb{R}^1$ under integration (see Figure

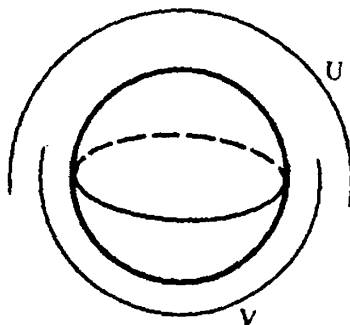

Figure 4.1

* In fact two manifolds have the same homotopy type in the C^∞ sense if and only if they have the same homotopy type in the usual (continuous) sense. This is because every continuous map between two manifolds is continuously homotopic to a C^∞ map (see Proposition 17.8).

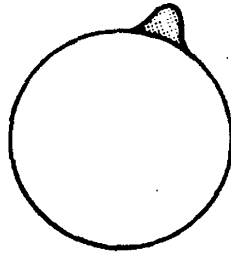

Figure 4.2

4.2). This bump 1-form propagates by the boundary map of the Mayer-Vietoris sequence to a bump 2-form on S^2 , which represents a generator of $H^2(S^2)$. In general a generator of $H^n(S^n)$ can be taken to be a bump n -form on S^n .

Exercise 4.3.1 Volume form on a sphere. Let $S^n(r)$ be the sphere of radius r

$$x_1^2 + \cdots + x_{n+1}^2 = r^2$$

in \mathbb{R}^{n+1} , and let

$$\omega = \frac{1}{r} \sum_{i=1}^{n+1} (-1)^{i-1} x_i dx_1 \cdots \widehat{dx}_i \cdots dx_{n+1}.$$

(a) Write S^n for the unit sphere $S^n(1)$. Compute the integral $\int_{S^n} \omega$ and conclude that ω is not exact.

(b) Regarding r as a function on $\mathbb{R}^{n+1} - 0$, show that $(dr) \cdot \omega = dx_1 \cdots dx_{n+1}$. Thus ω is the Euclidean volume form on the sphere $S^n(r)$.

From (a) we obtain an explicit formula for the generator of the top cohomology of S^n (although not as a bump form). For example, the generator of $H^2(S^2)$ is represented by

$$\sigma = \frac{1}{4\pi} (x_1 dx_2 dx_3 - x_2 dx_1 dx_3 + x_3 dx_1 dx_2).$$

The Poincaré Lemma for Compactly Supported Cohomology

The computation of the compactly supported cohomology $H_c^*(\mathbb{R}^n)$ is again by induction; we will show that there is an isomorphism

$$H_c^{*+1}(\mathbb{R}^n \times \mathbb{R}^1) \simeq H_c^*(\mathbb{R}^n).$$

Note that here, unlike the previous case, the dimension is shifted by one.

More generally consider the projection $\pi : M \times \mathbb{R}^1 \rightarrow M$. Since the pullback of a form on M to a form on $M \times \mathbb{R}^1$ necessarily has noncompact support, the pullback map π^* does not send $\Omega_c^*(M)$ to $\Omega_c^*(M \times \mathbb{R}^1)$. However, there is a push-forward map $\pi_* : \Omega_c^*(M \times \mathbb{R}^1) \rightarrow \Omega_c^{*-1}(M)$, called integration along the fiber, defined as follows. First note that a compactly

supported form on $M \times \mathbb{R}^1$ is a linear combination of two types of forms:

- (I) $\pi^*\phi \cdot f(x, t)$,
 (II) $\pi^*\phi \cdot f(x, t) dt$,

where ϕ is a form on the base (not necessarily with compact support), and $f(x, t)$ is a function with compact support. We define π_* by

$$(4.4) \quad \begin{aligned} \text{(I)} \quad & \pi_* \pi^*\phi \cdot f(x, t) \mapsto 0, \\ \text{(II)} \quad & \pi_* \pi^*\phi \cdot f(x, t) dt \mapsto \phi \int_{-\infty}^{\infty} f(x, t) dt. \end{aligned}$$

Exercise 4.5. Show that $d\pi_* = \pi_*d$; in other words, $\pi_* : \Omega_c^*(M \times \mathbb{R}^1) \rightarrow \Omega_c^{*-1}(M)$ is a chain map.

By this exercise π_* induces a map in cohomology $\pi_* : H_c^* \rightarrow H_c^{*-1}$. To produce a map in the reverse direction, let $e = e(t) dt$ be a compactly supported 1-form on \mathbb{R}^1 with total integral 1 and define

$$e_* : \Omega_c^*(M) \rightarrow \Omega_c^{*+1}(M \times \mathbb{R}^1)$$

by

$$\phi \mapsto \phi \wedge e.$$

The map e_* clearly commutes with d , so it also induces a map in cohomology. It follows directly from the definition that $\pi_* \circ e_* = 1$ on $\Omega_c^*(\mathbb{R}^n)$. Although $e_* \circ \pi_* \neq 1$ on the level of forms, we shall produce a homotopy operator K between 1 and $e_* \circ \pi_*$; it will then follow that $e_* \circ \pi_* = 1$ in cohomology.

To streamline the notation, write $\phi \cdot f$ for $\pi^*\phi \cdot f(x, t)$ and $\int f$ for $\int f(x, t) dt$. The homotopy operator $K : \Omega_c^*(M \times \mathbb{R}^1) \rightarrow \Omega_c^{*-1}(M \times \mathbb{R}^1)$ is defined by

$$\begin{aligned} \text{(I)} \quad & \phi \cdot f \mapsto 0, \\ \text{(II)} \quad & \phi \cdot f dt \mapsto \phi \int_{-\infty}^t f - \phi A(t) \int_{-\infty}^{\infty} f \quad \text{where } A(t) = \int_{-\infty}^t e. \end{aligned}$$

Proposition 4.6. $1 - e_* \pi_* = (-1)^{q-1}(dK - Kd)$ on $H_c^q(M \times \mathbb{R}^1)$.

PROOF. On forms of type (I), assuming $\deg \phi = q$, we have

$$(1 - e_* \pi_*)\phi \cdot f = \phi \cdot f,$$

$$\begin{aligned} (dK - Kd)\phi \cdot f &= -K \left(d\phi \cdot f + (-1)^q \phi \frac{\partial f}{\partial x} dx + (-1)^q \phi \frac{\partial f}{\partial t} dt \right) \\ &= (-1)^{q-1} \left(\phi \int_{-\infty}^t \frac{\partial f}{\partial t} - \phi A(t) \int_{-\infty}^{\infty} \frac{\partial f}{\partial t} \right) \\ &= (-1)^{q-1} \phi f. \quad \left[\text{Here } \int_{-\infty}^{\infty} \frac{\partial f}{\partial t} = f(x, \infty) - f(x, -\infty) = 0. \right] \end{aligned}$$

•
So

$$1 - e_* \pi_* = (-1)^{q-1} (dK - Kd).$$

On forms of type (II), now assuming $\deg \phi = q - 1$, we have

$$(1 - e_* \pi_*) \phi f dt = \phi f dt - \phi \left(\int_{-\infty}^{\infty} f \right) \wedge e,$$

$$\begin{aligned} (dK)(\phi f dt) &= (d\phi) \int_{-\infty}^t f + (-1)^{q-1} \phi \int_{-\infty}^t \frac{\partial f}{\partial x} dx dt + (-1)^{q-1} \phi f dt \\ &\quad - (d\phi)A(t) \int_{-\infty}^{\infty} f - (-1)^{q-1} \phi \left[e \int_{-\infty}^{\infty} f + A(t) \left(\int_{-\infty}^{\infty} \frac{\partial f}{\partial x} dx \right) \right] \end{aligned}$$

$$\begin{aligned} (Kd)(\phi f dt) &= K \left((d\phi) \cdot f dt + (-1)^{q-1} \phi \frac{\partial f}{\partial x} dx dt \right) \\ &= (d\phi) \int_{-\infty}^t f - (d\phi)A(t) \int_{-\infty}^{\infty} f \\ &\quad + (-1)^{q-1} \left[\phi \int_{-\infty}^t \frac{\partial f}{\partial x} dx dt - \phi A(t) \left(\int_{-\infty}^{\infty} \frac{\partial f}{\partial x} dx \right) \right]. \end{aligned}$$

So

$$(dK - Kd)\phi f dt = (-1)^{q-1} \left[\phi f dt - \phi \left(\int_{-\infty}^{\infty} f \right) e \right]$$

and the formula again holds. □

This concludes the proof of the following

Proposition 4.7. *The maps*

$$H_c^*(M \times \mathbb{R}^1) \xrightleftharpoons[e_*]{\pi_*} H_c^{*+1}(M)$$

are isomorphisms.

Corollary 4.7.1 (Poincaré Lemma for Compact Supports).

$$H_c^*(\mathbb{R}^n) = \begin{cases} \mathbb{R} & \text{in dimension } n \\ 0 & \text{otherwise.} \end{cases}$$

Here the isomorphism $H_c^n(\mathbb{R}^n) \cong \mathbb{R}$ is given by iterated π_* , i.e., by integration over \mathbb{R}^n .

To determine a generator for $H_c^n(\mathbb{R}^n)$, we start with the constant function 1 on a point and iterate with e_* . This gives $e(x_1) dx_1 e(x_2) dx_2 \dots e(x_n) dx_n$.

So a generator for $H_c^n(\mathbb{R}^n)$ is a bump n -form $\alpha(x) dx_1 \dots dx_n$ with

$$\int_{\mathbb{R}^n} \alpha(x) dx_1 \dots dx_n = 1.$$

The support of α can be made as small as we like.

REMARK. This Poincaré lemma shows that the compactly supported cohomology is not invariant under homotopy equivalence, although it is of course invariant under diffeomorphisms.

Exercise 4.8. Compute the cohomology groups $H^*(M)$ and $H_c^*(M)$ of the open Möbius strip M , i.e., the Möbius strip without the bounding edge (Figure 4.3). [*Hint:* Apply the Mayer-Vietoris sequences.]

The Degree of a Proper Map

As an application of the Poincaré lemma for compact supports we introduce here a C^∞ invariant of a proper map between two Euclidean spaces of the same dimension. Later, after Poincaré duality, this will be generalized to a proper map between any two oriented manifolds; for compact manifolds the properness assumption is of course redundant.

Let $f: \mathbb{R}^n \rightarrow \mathbb{R}^n$ be a proper map. Then the pullback $f^*: H_c^n(\mathbb{R}^n) \rightarrow H_c^n(\mathbb{R}^n)$ is defined. It carries a generator of $H_c^n(\mathbb{R}^n)$, i.e., a compactly supported closed form with total integral one, to some multiple of the generator. This multiple is defined to be the degree of f . If α is a generator of $H_c^n(\mathbb{R}^n)$, then

$$\text{deg } f = \int_{\mathbb{R}^n} f^* \alpha.$$

A priori the degree of a proper map is a real number; surprisingly, it turns out to be an integer. To see this, we need Sard's theorem. Recall that a critical point of a smooth map $f: \mathbb{R}^n \rightarrow \mathbb{R}^n$ is a point p where the differential $(f_*)_p: T_p \mathbb{R}^n \rightarrow T_{f(p)} \mathbb{R}^n$ is not surjective, and a critical value is the image of a critical point. A point of \mathbb{R}^n which is not a critical value is called a regular value. According to this definition any point of \mathbb{R}^n which is not in the image of f is a regular value so that the inverse image of a regular value may be empty.

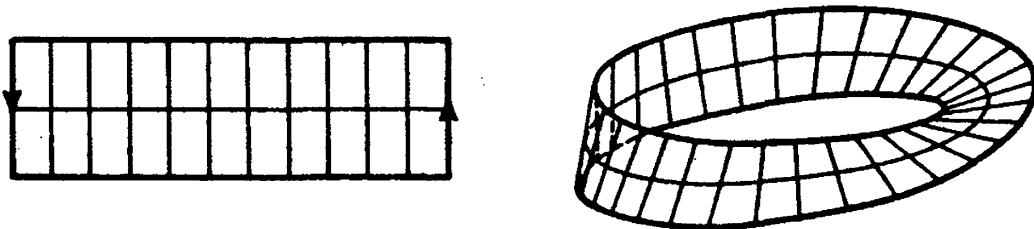

Figure 4.3

Theorem 4.9 (Sard's Theorem for \mathbb{R}^n). *The set of critical values of a smooth map $f : \mathbb{R}^m \rightarrow \mathbb{R}^n$ has measure zero in \mathbb{R}^n for any integers m and n .*

This means that given any $\epsilon > 0$, the set of critical values can be covered by cubes with total volume less than ϵ . Important special cases of this theorem were first published by A. P. Morse [1]. Sard's proof of the general case may be found in Sard [1].

Proposition 4.10 *Let $f : \mathbb{R}^n \rightarrow \mathbb{R}^n$ be a proper map. If f is not surjective, then it has degree 0.*

PROOF. Since the image of a proper map is closed (why?), if f misses a point q , it must miss some neighborhood U of q . Choose a bump n -form α whose support lies in U . Then $f^*\alpha \equiv 0$ so that $\deg f = 0$. \square

Exercise 4.10.1. Prove that the image of a proper map is closed.

So to show that the degree is an integer we only need to look at surjective proper maps from \mathbb{R}^n to \mathbb{R}^n . By Sard's theorem, almost all points in the image of such a map are regular values. Pick one regular value, say q . By hypothesis the inverse image of q is nonempty. Since in our case the two Euclidean spaces have the same dimension, the differential f_* is surjective if and only if it is an isomorphism. So by the inverse function theorem, around any point in the pre-image of q , f is a local diffeomorphism. It follows that $f^{-1}(q)$ is a discrete set of points. Since f is proper, $f^{-1}(q)$ is in fact a finite set of points. Choose a generator α of $H_c^n(\mathbb{R}^n)$ whose support is localized near q . Then $f^*\alpha$ is an n -form whose support is localized near the points of $f^{-1}(q)$ (see Figure 4.4). As noted earlier, a diffeomorphism preserves an integral only up to sign, so the integral of $f^*\alpha$ near each point of $f^{-1}(q)$ is ± 1 . Thus

$$\int_{\mathbb{R}^n} f^*\alpha = \sum_{f^{-1}(q)} \pm 1.$$

This proves that the degree of a proper map between two Euclidean spaces of the same dimension is an integer. More precisely, it shows that the number of

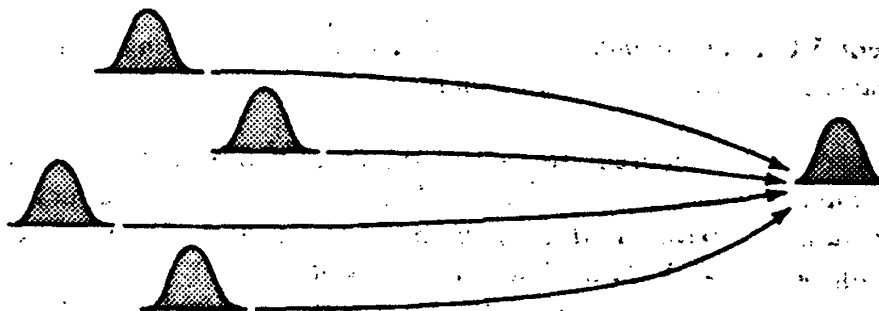

Figure 4.4

points, counted with multiplicity ± 1 , in the inverse image of any regular value is the same for all regular values and that this number is equal to the degree of the map.

Sard's theorem for \mathbb{R}^n , a key ingredient of this discussion, has a natural extension to manifolds. We take this opportunity to state Sard's theorem in general. A subset S of a manifold M is said to have *measure zero* if it can be covered by countably many coordinate open sets U_i such that $\phi_i(S \cap U_i)$ has measure zero in \mathbb{R}^n ; here ϕ_i is the trivialization on U_i . A *critical point* of a smooth map $f : M \rightarrow N$ between two manifolds is a point p in M where the differential $(f_*)_p : T_p M \rightarrow T_{f(p)} N$ is not surjective, and a *critical value* is the image of a critical point.

Theorem 4.11 (Sard's Theorem). *The set of critical values of a smooth map $f : M \rightarrow N$ has measure zero.*

Exercise 4.11.1. Prove Theorem 4.11 from Sard's theorem for \mathbb{R}^n .

§5 The Mayer-Vietoris Argument

The Mayer-Vietoris sequence relates the cohomology of a union to those of the subsets. Together with the Five Lemma, this gives a method of proof which proceeds by induction on the cardinality of an open cover, called the *Mayer-Vietoris argument*. As evidence of its power and versatility, we derive from it the finite dimensionality of the de Rham cohomology, Poincaré duality, the Künneth formula, the Leray-Hirsch theorem, and the Thom isomorphism, all for manifolds with finite good cover.

Existence of a Good Cover

Let M be a manifold of dimension n . An open cover $\mathcal{U} = \{U_\alpha\}$ of M is called a *good cover* if all finite intersections $U_{\alpha_0} \cap \cdots \cap U_{\alpha_r}$ are diffeomorphic to \mathbb{R}^n . A manifold which has a finite good cover is said to be of *finite type*.

Theorem 5.1. *Every manifold has a good cover. If the manifold is compact, then the cover may be chosen to be finite.*

To prove this theorem we will need a little differential geometry. A *Riemannian structure* on a manifold M is a smoothly varying metric $\langle \cdot, \cdot \rangle$ on the tangent space of M at each point; it is smoothly varying in the following sense: if X and Y are two smooth vector fields on M , then $\langle X, Y \rangle$ is a smooth function on M . Every manifold can be given a Riemannian structure by the following splicing procedure. Let $\{U_\alpha\}$ be a

coordinate open cover of M , $\langle \cdot, \cdot \rangle_a$ a Riemannian metric on U_a , and $\{\rho_a\}$ a partition of unity subordinate to $\{U_a\}$. Then $\langle \cdot, \cdot \rangle = \sum \rho_a \langle \cdot, \cdot \rangle_a$ is a Riemannian metric on M .

PROOF OF THEOREM 5.1. Endow M with a Riemannian structure. Now we quote the theorem in differential geometry that every point in a Riemannian manifold has a geodesically convex neighborhood (Spivak [1, Ex. 32(f), p. 491]). The intersection of any two such neighborhoods is again geodesically convex. Since a geodesically convex neighborhood in a Riemannian manifold of dimension n is diffeomorphic to \mathbb{R}^n , an open cover consisting of geodesically convex neighborhoods will be a good cover. \square

Given two covers $\mathcal{U} = \{U_\alpha\}_{\alpha \in I}$ and $\mathcal{B} = \{V_\beta\}_{\beta \in J}$, if every V_β is contained in some U_α , we say that \mathcal{B} is a *refinement* of \mathcal{U} and write $\mathcal{U} > \mathcal{B}$. To be more precise we specify a refinement by a map $\phi: J \rightarrow I$ such that $V_\beta \subset U_{\phi(\beta)}$. By a slight modification of the above proof we can show that *every open cover on a manifold has a refinement which is a good cover*: simply take the geodesically convex neighborhoods around each point to be inside some open set of the given cover.

A *directed set* is a set I with a partial order $>$ such that for any two elements a and b in I , there is an element c with $a > c$ and $b > c$. The set of open covers on a manifold is a directed set, since any two open covers always have a common refinement. A subset J of a directed set I is *cofinal* in I if for every i in I there is a j in J such that $i > j$. It is clear that J is also a directed set.

Corollary 5.2. *The good covers are cofinal in the set of all covers of a manifold M .*

Finite Dimensionality of de Rham Cohomology

Proposition 5.3.1 *If the manifold M has a finite good cover, then its cohomology is finite dimensional.*

PROOF. From the Mayer-Vietoris sequence

$$\cdots \rightarrow H^{q-1}(U \cap V) \xrightarrow{d^*} H^q(U \cup V) \xrightarrow{r} H^q(U) \oplus H^q(V) \rightarrow \cdots$$

we get

$$H^q(U \cup V) \simeq \ker r \oplus \operatorname{im} r \simeq \operatorname{im} d^* \oplus \operatorname{im} r.$$

Thus,

(*) *if the q th cohomology of U , V , and $U \cap V$ are finite dimensional, then so is the q th cohomology of $U \cup V$.*

For a manifold which is diffeomorphic to \mathbb{R}^n , the finite dimensionality of

$H^*(M)$ follows from the Poincaré lemma (41.1). We now proceed by induction on the cardinality of a good cover. Suppose the cohomology of any manifold having a good cover with at most p open sets is finite dimensional. Consider a manifold having a good cover $\{U_0, \dots, U_p\}$ with $p+1$ open sets. Now $(U_0 \cup \dots \cup U_{p-1}) \cap U_p$ has a good cover with p open sets, namely $\{U_{0,p}, U_{1,p}, \dots, U_{p-1,p}\}$. By hypothesis, the q th cohomology of $U_0 \cup \dots \cup U_{p-1}, U_p$ and $(U_0 \cup \dots \cup U_{p-1}) \cap U_p$ are finite dimensional; from Remark (*), so is the q th cohomology of $U_0 \cup \dots \cup U_p$. This completes the induction. \square

Similarly,

Proposition 5.3.2. *If the manifold M has a finite good cover, then its compact cohomology is finite dimensional.*

Poincaré Duality on an Orientable Manifold

A pairing between two finite-dimensional vector spaces

$$\langle \cdot, \cdot \rangle : V \otimes W \rightarrow \mathbb{R}$$

is said to be *nondegenerate* if $\langle v, w \rangle = 0$ for all w implies $v = 0$; equivalently, the map $v \mapsto \langle v, \cdot \rangle$ should define an isomorphism $V \cong W^*$.

Because the wedge product is an antiderivation, it descends to cohomology; by Stokes' theorem, integration also descends to cohomology. So for an oriented manifold M there is a pairing

$$\int : H^q(M) \otimes H_c^{n-q}(M) \rightarrow \mathbb{R}$$

given by the integral of the wedge product of two forms. Our first version of Poincaré duality asserts that this pairing is nondegenerate whenever M is orientable and has a finite good cover; equivalently,

$$(5.4) \quad H^q(M) \simeq (H_c^{n-q}(M))^*$$

Note that by (5.3.1) and (5.3.2) both $H^q(M)$ and $H_c^{n-q}(M)$ are finite-dimensional.

A couple of lemmas will be needed in the proof of Poincaré duality.

Exercise 5.5. Prove the Five Lemma: given a commutative diagram of Abelian groups

$$\begin{array}{ccccccccc} \cdots & \longrightarrow & A & \xrightarrow{f_1} & B & \xrightarrow{f_2} & C & \xrightarrow{f_3} & D & \xrightarrow{f_4} & E & \longrightarrow & \cdots \\ & & \alpha \downarrow & & \beta \downarrow & & \gamma \downarrow & & \delta \downarrow & & \varepsilon \downarrow & & \\ \cdots & \longrightarrow & A' & \xrightarrow{f_1} & B' & \xrightarrow{f_2} & C' & \xrightarrow{f_3} & D' & \xrightarrow{f_4} & E' & \longrightarrow & \cdots \end{array}$$

in which the rows are exact, if the maps α, β, δ and ε are isomorphisms, then so is the middle one γ .

Lemma 5.6. *The two Mayer-Vietoris sequences (2.4) and (2.8) may be paired together to form a sign-commutative diagram*

$$\begin{array}{ccccccc}
 \cdots & \rightarrow & H^q(U \cup V) & \xrightarrow{\text{restriction}} & H^q(U) \oplus H^q(V) & \xrightarrow{\text{difference}} & H^q(U \cap V) \xrightarrow{d^*} H^{q+1}(U \cup V) \rightarrow \cdots \\
 & & \otimes & & \otimes & & \otimes & & \otimes \\
 \cdots & \leftarrow & H_c^{n-q}(U \cup V) & \xleftarrow{\text{sum}} & H_c^{n-q}(U) \oplus H_c^{n-q}(V) & \xleftarrow{\text{difference}} & H_c^{n-q}(U \cap V) \xleftarrow{d_*} H_c^{n-q-1}(U \cup V) \\
 & & \downarrow \int_{U \cup V} & & \downarrow \int_U + \int_V & & \downarrow \int_{U \cap V} & & \downarrow \int_{U \cup V} \\
 & & \mathbb{R} & & \mathbb{R} & & \mathbb{R} & & \mathbb{R}
 \end{array}$$

Here sign-commutativity means, for instance, that

$$\int_{U \cap V} \omega \wedge d_* \tau = \pm \int_{U \cup V} (d^* \omega) \wedge \tau,$$

for $\omega \in H^q(U \cap V)$, $\tau \in H_c^{n-q-1}(U \cup V)$. This lemma is equivalent to saying that the pairing induces a map from the upper exact sequence to the dual of the lower exact sequence such that the following diagram is sign-commutative:

$$\begin{array}{ccccccc}
 \rightarrow & H^q & \rightarrow & H^q \oplus H^q & \rightarrow & H^q & \rightarrow \\
 & \downarrow & & \downarrow & & \downarrow & \\
 \rightarrow & (H_c^{n-q})^* & \rightarrow & (H_c^{n-q})^* \oplus (H_c^{n-q})^* & \rightarrow & (H_c^{n-q})^* & \rightarrow
 \end{array}$$

PROOF. The first two squares are in fact commutative as is straightforward to check. We will show the sign-commutativity of the third square.

Recall from (2.5) and (2.7) that $d^* \omega$ is a form in $H^{q+1}(U \cup V)$ such that

$$d^* \omega|_U = -d(\rho_V \omega)$$

$$d^* \omega|_V = d(\rho_U \omega),$$

and $d_* \tau$ is a form in $H_c^{n-q}(U \cap V)$ such that

$$\begin{aligned}
 & (-(\text{extension by 0 of } d_* \tau \text{ to } U), (\text{extension by 0 of } d_* \tau \text{ to } V)) \\
 & \qquad \qquad \qquad = (d(\rho_U \tau), d(\rho_V \tau)).
 \end{aligned}$$

Note that $d(\rho_V \tau) = (d\rho_V)\tau$ because τ is closed; similarly, $d(\rho_V \omega) = (d\rho_V)\omega$.

$$\int_{U \cap V} \omega \wedge d_* \tau = \int_{U \cap V} \omega \wedge (d\rho_V)\tau = (-1)^{d \cdot q} \int_{U \cap V} (d\rho_V)\omega \wedge \tau.$$

Since $d^* \omega$ has support in $U \cap V$,

$$\int_{U \cup V} d^* \omega \wedge \tau = - \int_{U \cap V} (d\rho_V)\omega \wedge \tau.$$

Therefore,

$$\int_{U \cap V} \omega \wedge d_* \tau = (-1)^{\deg \omega + 1} \int_{U \cup V} d^* \omega \wedge \tau. \quad \square$$

By the Five Lemma if Poincaré duality holds for U , V , and $U \cap V$, then it holds for $U \cup V$. We now proceed by induction on the cardinality of a good cover. For M diffeomorphic to \mathbb{R}^n , Poincaré duality follows from the two Poincaré lemmas

$$H^*(\mathbb{R}^n) = \begin{cases} \mathbb{R} & \text{in dimension } 0 \\ 0 & \text{elsewhere} \end{cases}$$

and

$$H_c^*(\mathbb{R}^n) = \begin{cases} \mathbb{R} & \text{in dimension } n \\ 0 & \text{elsewhere.} \end{cases}$$

Next suppose Poincaré duality holds for any manifold having a good cover with at most p open sets, and consider a manifold having a good cover $\{U_0, \dots, U_p\}$ with $p+1$ open sets. Now $(U_0 \cup \dots \cup U_{p-1}) \cap U_p$ has a good cover with p open sets, namely $\{U_{0,p}, U_{1,p}, \dots, U_{p-1,p}\}$. By hypothesis Poincaré duality holds for $U_0 \cup \dots \cup U_{p-1}$, U_p , and $(U_0 \cup \dots \cup U_{p-1}) \cap U_p$, so it holds for $U_0 \cup \dots \cup U_{p-1} \cup U_p$ as well. This induction argument proves Poincaré duality for any orientable manifold having a finite good cover. \square

REMARK 5.7. The finiteness assumption on the good cover is in fact not necessary. By a closer analysis of the topology of a manifold, the Mayer-Vietoris argument above can be extended to any orientable manifold (Greub, Halperin, and Vanstone [1, p. 198 and p. 14]). The statement is as follows: *if M is an orientable manifold of dimension n , whose cohomology is not necessarily finite dimensional, then*

$$H^q(M) \simeq (H_c^{n-q}(M))^* \quad , \quad \text{for any integer } q.$$

However, the reverse implication $H_c^q(M) \simeq (H^{n-q}(M))^*$ is not always true. The asymmetry comes from the fact that the dual of a direct sum is a direct product, but the dual of a direct product is not a direct sum. For example, consider the infinite disjoint union

$$M = \coprod_{i=1}^{\infty} M_i,$$

where the M_i 's are all manifolds of finite type of the same dimension n . Then the de Rham cohomology is a direct product

$$(5.7.1) \quad H^q(M) = \prod_i H^q(M_i),$$

but the compact cohomology is a direct sum

$$(5.7.2) \quad H_c^q(M) = \bigoplus_i H_c^q(M_i).$$

Taking the dual of the compact cohomology $H_c^q(M)$ gives a direct product

$$(5.7.3) \quad (H_c^q(M))^* = \prod_i (H_c^q(M_i))^*.$$

So by (5.7.1) and (5.7.3), it follows from Poincaré duality for the manifolds of finite type M_i , that

$$H^q(M) = (H_c^{n-q}(M))^*.$$

Corollary 5.8. *If M is a connected oriented manifold of dimension n , then $H_c^n(M) \simeq \mathbb{R}$. In particular if M is compact oriented and connected, $H^n(M) \simeq \mathbb{R}$.*

Let $f : M \rightarrow N$ be a map between two compact oriented manifolds of dimension n . Then there is an induced map in cohomology

$$f^* : H^n(N) \rightarrow H^n(M).$$

The *degree* of f is defined to be $\int_M f^* \omega$, where ω is the generator of $H^n(N)$. By the same argument as for the degree of a proper map between two Euclidean spaces, the degree of a map between two compact oriented manifolds is an integer and is equal to the number of points, counted with multiplicity ± 1 , in the inverse image of any regular point in N .

The Künneth Formula and the Leray-Hirsch Theorem

The Künneth formula states that the cohomology of the product of two manifolds M and F is the tensor product

$$(5.9) \quad H^*(M \times F) = H^*(M) \otimes H^*(F).$$

This means

$$H^n(M \times F) = \bigoplus_{p+q=n} H^p(M) \otimes H^q(F) \quad \text{for every } n.$$

More generally we are interested in the cohomology of a *fiber bundle*.

Definition. Let G be a topological group which acts effectively on a space F on the left. A surjection $\pi : E \rightarrow B$ between topological spaces is a *fiber bundle with fiber F and structure group G* if B has an open cover $\{U_\alpha\}$ such that there are homeomorphisms

$$\phi_\alpha : E|_{U_\alpha} \simeq U_\alpha \times F$$

and the transition functions are continuous functions with values in G :

$$g_{\alpha\beta}(x) = \phi_\alpha \phi_\beta^{-1} |_{(x) \times F} \in G.$$

Sometimes the *total space* E is referred to as the fiber bundle. A fiber bundle with structure group G is also called a G -bundle. If $x \in B$, the set $E_x = \pi^{-1}(x)$ is called the fiber at x .

Since we are working with de Rham theory, the spaces E , B , and F will be assumed to be C^∞ manifolds and the maps C^∞ maps. We may also speak of a fiber bundle without mentioning its structure group; in that case, the group is understood to be the group of diffeomorphisms of F , denoted $\text{Diff}(F)$.

REMARK. The action of a group G on a space F is said to be *effective* if the only element of G which acts trivially on F is the identity, i.e., if $g \cdot y = y$ for all y in F , then $g = 1 \in G$. In the C^∞ case, this is equivalent to saying that the kernel of the natural map $G \rightarrow \text{Diff}(F)$ is the identity or that G is a subgroup of $\text{Diff}(F)$, the group of diffeomorphisms of F . In the definition of a fiber bundle the action of G on F is required to be effective in order that the diffeomorphism

$$\phi_\alpha \phi_\beta^{-1} |_{(x) \times F}$$

of F can be identified unambiguously with an element of G .

The transition functions $g_{\alpha\beta} : U_\alpha \cap U_\beta \rightarrow G$ satisfy the cocycle condition:

$$g_{\alpha\beta} \cdot g_{\beta\gamma} = g_{\alpha\gamma}.$$

Given a cocycle $\{g_{\alpha\beta}\}$ with values in G we can construct a fiber bundle E having $\{g_{\alpha\beta}\}$ as its transition functions by setting

$$(5.10) \quad E = \left(\coprod U_\alpha \times F \right) / (x, y) \sim (x, g_{\alpha\beta}(x)y)$$

for (x, y) in $U_\beta \times F$ and $(x, g_{\alpha\beta}(x)y)$ in $U_\alpha \times F$.

The following proof of the Künneth formula assumes that M has a finite good cover. This assumption is necessary for the induction argument.

The two natural projections

$$\begin{array}{ccc} M \times F & \xrightarrow{\rho} & F \\ \downarrow \pi & & \\ M & & \end{array}$$

give rise to a map on forms

$$\omega \otimes \phi \mapsto \pi^* \omega \wedge \rho^* \phi$$

which induces a map in cohomology (exercise)

$$\psi : H^*(M) \otimes H^*(F) \rightarrow H^*(M \times F).$$

We will show that ψ is an isomorphism.

If $M = \mathbb{R}^n$, this is simply the Poincaré lemma.

In the following we will regard $M \times F$ as a product bundle over M . Let U and V be open sets in M and n a fixed integer. From the Mayer-Vietoris sequence

$$\cdots \rightarrow H^p(U \cup V) \rightarrow H^p(U) \oplus H^p(V) \rightarrow H^p(U \cap V) \cdots$$

we get an exact sequence by tensoring with $H^{n-p}(F)$

$$\begin{aligned} \cdots \rightarrow H^p(U \cup V) \otimes H^{n-p}(F) &\rightarrow (H^p(U) \otimes H^{n-p}(F)) \oplus (H^p(V) \otimes H^{n-p}(F)) \\ &\rightarrow H^p(U \cap V) \otimes H^{n-p}(F) \rightarrow \cdots \end{aligned}$$

since tensoring with a vector space preserves exactness. Summing over $p = 0, \dots, n$, yields the exact sequence

$$\begin{aligned} \cdots \rightarrow \bigoplus_{p=0}^n H^p(U \cup V) \otimes H^{n-p}(F) \\ \rightarrow \bigoplus_{p=0}^n (H^p(U) \otimes H^{n-p}(F)) \oplus (H^p(V) \otimes H^{n-p}(F)) \\ \rightarrow \bigoplus_{p=0}^n H^p(U \cap V) \otimes H^{n-p}(F) \rightarrow \cdots \end{aligned}$$

The following diagram is commutative

$$\begin{array}{ccccc} \bigoplus_{p=0}^n (H^p(U \cup V) \otimes H^{n-p}(F)) & \rightarrow & \bigoplus_{p=0}^n (H^p(U) \otimes H^{n-p}(F)) \oplus (H^p(V) \otimes H^{n-p}(F)) & \rightarrow & \bigoplus_{p=0}^n H^p(U \cap V) \otimes H^{n-p}(F) \\ \downarrow \psi & & \downarrow \psi & & \downarrow \psi \\ H^n((U \cup V) \times F) & \longrightarrow & H^n(U \times F) \oplus H^n(V \times F) & \longrightarrow & H^n((U \cap V) \times F) \end{array}$$

The commutativity is clear except possibly for the square

$$\begin{array}{ccc} \bigoplus (H^p(U \cap V) \otimes H^{n-p}(F)) & \xrightarrow{d^*} & \bigoplus H^{p+1}(U \cup V) \otimes H^{n-p}(F) \\ \downarrow \psi & & \downarrow \psi \\ H^n((U \cap V) \times F) & \xrightarrow{d^*} & H^n((U \cup V) \times F), \end{array}$$

which we now check. Let $\omega \otimes \phi$ be in $H^p(U \cap V) \otimes H^{n-p}(F)$. Then

$$\begin{aligned} \psi d^*(\omega \otimes \phi) &= \pi^*(d^*\omega) \wedge \rho^*\phi \\ d^*\psi(\omega \otimes \phi) &= d^*(\pi^*\omega \wedge \rho^*\phi). \end{aligned}$$

Recall from (2.5) that if $\{\rho_U, \rho_V\}$ is a partition of unity subordinate to $\{U, V\}$ then

$$d^*\omega = \begin{cases} -d(\rho_V \omega) & \text{on } U \\ d(\rho_U \omega) & \text{on } V. \end{cases}$$

Since the pullback functions $\{\pi^*\rho_U, \pi^*\rho_V\}$ form a partition of unity on $(U \cup V) \times F$ subordinate to the cover $\{U \times F, V \times F\}$, on $(U \cap V) \times F$

$$\begin{aligned} d^*(\pi^*\omega \wedge \rho^*\phi) &= d((\pi^*\rho_U)\pi^*\omega \wedge \rho^*\phi) \\ &= (d\pi^*(\rho_U \omega)) \wedge \rho^*\phi \quad \text{since } \phi \text{ is closed} \\ &= \pi^*(d^*\omega) \wedge \rho^*\phi. \end{aligned}$$

So the diagram is commutative.

By the Five Lemma if the theorem is true for U , V , and $U \cap V$, then it is also true for $U \cup V$. The Künneth formula now follows by induction on the cardinality of a good cover, as in the proof of Poincaré duality. \square

Let $\pi: E \rightarrow M$ be a fiber bundle with fiber F . Suppose there are cohomology classes e_1, \dots, e_r on E which restrict to a basis of the cohomology of each fiber. Then we can define a map

$$\psi: H^*(M) \otimes \mathbb{R}\{e_1, \dots, e_r\} \rightarrow H^*(E).$$

The same argument as the Künneth formula gives

Theorem 5.11 (Leray-Hirsch). *Let E be a fiber bundle over M with fiber F . Suppose M has a finite good cover. If there are global cohomology classes e_1, \dots, e_r on E which when restricted to each fiber freely generate the cohomology of the fiber, then $H^*(E)$ is a free module over $H^*(M)$ with basis $\{e_1, \dots, e_r\}$, i.e.*

$$H^*(E) \simeq H^*(M) \otimes \mathbb{R}\{e_1, \dots, e_r\} \simeq H^*(M) \otimes H^*(F).$$

Exercise 5.12 Künneth formula for compact cohomology. The Künneth formula for compact cohomology states that for any manifolds M and N having a finite good cover.

$$H_c^*(M \times N) = H_c^*(M) \otimes H_c^*(N).$$

(a) In case M and N are orientable, show that this is a consequence of Poincaré duality and the Künneth formula for de Rham cohomology.

(b) Using the Mayer-Vietoris argument prove the Künneth formula for compact cohomology for any M and N having a finite good cover.

The Poincaré Dual of a Closed Oriented Submanifold

Let M be an oriented manifold of dimension n and S a closed oriented submanifold of dimension k ; here by "closed" we mean as a subspace of M . Figure 5.1 is a closed submanifold of $\mathbb{R}^2 - \{0\}$, but Figure 5-2 is not. To every closed oriented submanifold $i: S \hookrightarrow M$ of dimension k , one can associ-

ate a unique cohomology class $[\eta_S]$ in $H^{n-k}(M)$, called its *Poincaré dual*, as follows. Let ω be a closed k -form with compact support on M . Since S is

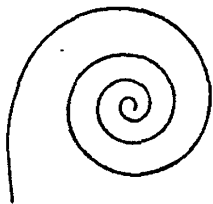

Figure 5.1



Figure 5.2

closed in M , $\text{Supp}(\omega|_S)$ is closed not only in S , but also in M . Now because $\text{Supp}(\omega|_S) \subset (\text{Supp } \omega) \cap S$ is a closed subset of a compact set, $i^*\omega$ also has compact support on S , so the integral $\int_S i^*\omega$ is defined. By Stokes's theorem integration over S induces a linear functional on $H_c^k(M)$. It follows by Poincaré duality: $(H_c^k(M))^* \simeq H^{n-k}(M)$, that integration over S corresponds to a unique cohomology class $[\eta_S]$ in $H^{n-k}(M)$. We will often call both the cohomology class $[\eta_S]$ and a form representing it the *Poincaré dual* of S . By definition the Poincaré dual η_S is the unique cohomology class in $H^{n-k}(M)$ satisfying

$$(5.13) \quad \int_S i^*\omega = \int_M \omega \wedge \eta_S$$

for any ω in $H_c^k(M)$.

Now suppose S is a *compact* oriented submanifold of dimension k in M . Since a compact subset of a Hausdorff space is closed, S is also a closed oriented submanifold and hence has a Poincaré dual $\eta_S \in H^{n-k}(M)$. This η_S we will call the *closed Poincaré dual* of S , to distinguish it from the *compact Poincaré dual* to be defined below. Because S is compact, one can in fact integrate over S not only k -forms with compact support on M , but *any* k -form on M . In this way S defines a linear functional on $H^k(M)$, and so by Poincaré duality corresponds to a unique cohomology class $[\eta'_S]$ in $H_c^{n-k}(M)$, the *compact Poincaré dual* of S . We must assume here that M has a finite good cover; otherwise, the duality $(H^k(M))^* \simeq H_c^{n-k}(M)$ does not hold. The compact Poincaré dual $[\eta'_S]$ is uniquely characterized by

$$(5.14) \quad \int_S i^*\omega = \int_M \omega \wedge \eta'_S,$$

for any $\omega \in H^k(M)$. If (5.14) holds for any closed k -form ω , then it certainly holds for any closed k -form ω with compact support. So *as a form*, η'_S is also the closed Poincaré dual of S , i.e., the natural map $H_c^{n-k}(M) \rightarrow H^{n-k}(M)$ sends the compact Poincaré dual to the closed Poincaré dual. Therefore we can in fact demand the closed Poincaré dual of a compact oriented submanifold to have compact support. However, as cohomology classes, $[\eta_S] \in H^{n-k}(M)$ and $[\eta'_S] \in H_c^{n-k}(M)$ could be quite different, as the following examples demonstrate.

EXAMPLE 5.15 (The Poincaré duals of a point P on \mathbb{R}^n). Since $H^n(\mathbb{R}^n) = 0$, the closed Poincaré dual η_P is trivial and can be represented by any closed n -form on \mathbb{R}^n , but the compact Poincaré dual is the nontrivial class in $H_c^n(\mathbb{R}^n)$ represented by a bump form with total integral 1.

EXAMPLE-EXERCISE 5.16 (The ray and the circle in $\mathbb{R}^2 - \{0\}$). Let x, y be the standard coordinates and r, θ the polar coordinates on $\mathbb{R}^2 - \{0\}$.

(a) Show that the Poincaré dual of the ray $\{(x, 0) \mid x > 0\}$ in $\mathbb{R}^2 - \{0\}$ is $d\theta/2\pi$ in $H^1(\mathbb{R}^2 - \{0\})$.

(b) Show that the closed Poincaré dual of the unit circle in $H^1(\mathbb{R}^2 - \{0\})$ is 0, but the compact Poincaré dual is the nontrivial generator $\rho(r)dr$ in $H_c^1(\mathbb{R}^2 - \{0\})$ where $\rho(r)$ is a bump function with total integral 1. (By a bump function we mean a smooth function whose support is contained in some disc and whose graph looks like a "bump".)

Thus the generator of $H^1(\mathbb{R}^2 - \{0\})$ is represented by the ray and the generator of $H_c^1(\mathbb{R}^2 - \{0\})$ by the circle (see Figure 5.3).

REMARK 5.17. The two Poincaré duals of a compact oriented submanifold correspond to the two homology theories—closed homology and compact homology. Closed homology has now fallen into disuse, while compact homology is known these days as the homology of singular chains. In Example-Exercise 5.16, the generator of $H_{1, \text{closed}}(\mathbb{R}^2 - \{0\})$ is the ray, while the generator of $H_{1, \text{compact}}(\mathbb{R}^2 - \{0\})$ is the circle. (The circle is a boundary in closed homology since the punctured closed disk is a closed 2-chain in $\mathbb{R}^2 - \{0\}$.) In general Poincaré duality sets up an isomorphism between closed homology and de Rham cohomology, and between compact homology and compact de Rham cohomology.

Let S be a compact oriented submanifold of dimension k in M . If $W \subset M$ is an open subset containing S , then the compact Poincaré dual of S in W , $\eta'_{S, W} \in H_c^{n-k}(W)$, extends by 0 to a form η'_S in $H_c^{n-k}(M)$. η'_S is clearly the compact Poincaré dual of S in M because

$$\int_S i^* \omega = \int_W \omega \wedge \eta'_{S, W} = \int_M \omega \wedge \eta'_S.$$

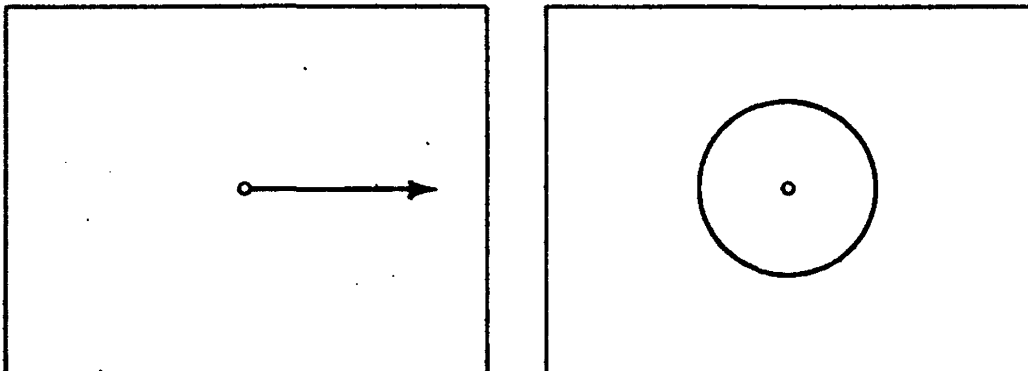

Figure 5.3

Thus, the support of the compact Poincaré dual of S in M may be shrunk into any open neighborhood of S . This is called the *localization principle*. For a noncompact closed oriented submanifold S the localization principle also holds. We will take it up in Proposition 6.25.

In this book we will mean by the Poincaré dual the *closed* Poincaré dual. However, as we have seen, if the submanifold is compact, we can demand that its closed Poincaré dual have compact support, even as a cohomology class in $H^{n-k}(M)$. Of course, on a compact manifold M , there is no distinction between the closed and the compact Poincaré duals.

§6 The Thom Isomorphism

So far we have encountered two kinds of C^∞ invariants of a manifold, de Rham cohomology and compactly supported cohomology. For vector bundles there is another invariant, namely, cohomology with compact support *in the vertical direction*. The Thom isomorphism is a statement about this last-named cohomology. In this section we use the Mayer-Vietoris argument to prove the Thom isomorphism for an orientable vector bundle. We then explain why the Poincaré dual and the Thom class are in fact one and the same thing. Using the interpretation of the Poincaré dual of a submanifold as the Thom class of the normal bundle, it is easy to write down explicitly the Poincaré dual, at least when the normal bundle is trivial. Next we give an explicit construction of the Thom class for an oriented rank 2 bundle, introducing along the way the global angular form and the Euler class. The higher-rank analogues will be taken up in Sections 11 and 12. We conclude this section with a brief discussion of the relative de Rham theory, citing the Thom class as an example of a relative class.

Vector Bundles and the Reduction of Structure Groups

Let $\pi: E \rightarrow M$ be a surjective map of manifolds whose fiber $\pi^{-1}(x)$ is a vector space for every x in M . The map π is a C^∞ *real vector bundle* of rank n if there is an open cover $\{U_\alpha\}$ of M and fiber-preserving diffeomorphisms

$$\phi_\alpha: E|_{U_\alpha} = \pi^{-1}(U_\alpha) \simeq U_\alpha \times \mathbb{R}^n$$

which are linear isomorphisms on each fiber. The maps

$$\phi_\alpha \circ \phi_\beta^{-1}: (U_\alpha \cap U_\beta) \times \mathbb{R}^n \rightarrow (U_\alpha \cap U_\beta) \times \mathbb{R}^n$$

are vector-space automorphisms of \mathbb{R}^n in each fiber and hence give rise to maps

$$\theta_{\alpha\beta}: U_\alpha \cap U_\beta \rightarrow GL(n, \mathbb{R})$$

$$\theta_{\alpha\beta}(x) = \phi_\alpha \phi_\beta^{-1}|_{\{x\} \times \mathbb{R}^n}.$$

In the terminology of Section 5 a vector bundle of rank n is a fiber bundle with fiber \mathbb{R}^n and structure group $GL(n, \mathbb{R})$. If the fiber is \mathbb{C}^n and the

structure group is $GL(n, \mathbb{C})$, the vector bundle is a *complex vector bundle*. Unless otherwise stated, by a vector bundle we mean a C^∞ real vector bundle.

Let U be an open set in M . A map $s : U \rightarrow E$ is a *section* of the vector bundle E over U if $\pi \circ s$ is the identity on U . The space of all sections over U is written $\Gamma(U, E)$. Note that every vector bundle has a well-defined global zero section. A collection of sections s_1, \dots, s_n over an open set U in M is a *frame* on U if for every point x in U , $s_1(x), \dots, s_n(x)$ form a basis of the vector space $E_x = \pi^{-1}(x)$.

The transition functions $\{g_{\alpha\beta}\}$ of a vector bundle satisfy the *cocycle condition*

$$g_{\alpha\beta} \circ g_{\beta\gamma} = g_{\alpha\gamma} \quad \text{on} \quad U_\alpha \cap U_\beta \cap U_\gamma.$$

The cocycle $\{g_{\alpha\beta}\}$ depends on the choice of the trivialization.

Lemma 6.1. *If the cocycle $\{g'_{\alpha\beta}\}$ comes from another trivialization $\{\phi'_\alpha\}$, then there exist maps $\lambda_\alpha : U_\alpha \rightarrow GL(n, \mathbb{R})$ such that*

$$g_{\alpha\beta} = \lambda_\alpha g'_{\alpha\beta} \lambda_\beta^{-1} \quad \text{on} \quad U_\alpha \cap U_\beta.$$

PROOF. The two trivializations differ by a nonsingular transformation of \mathbb{R}^n at each point:

$$\phi_\alpha = \lambda_\alpha \phi'_\alpha, \quad \lambda_\alpha : U_\alpha \rightarrow GL(n, \mathbb{R}).$$

Therefore,

$$g_{\alpha\beta} = \phi_\alpha \phi_\beta^{-1} = \lambda_\alpha \phi'_\alpha \phi'_\beta^{-1} \lambda_\beta^{-1} = \lambda_\alpha g'_{\alpha\beta} \lambda_\beta^{-1}. \quad \square$$

Two cocycles related in this way are said to be *equivalent*.

Given a cocycle $\{g_{\alpha\beta}\}$ with values in $GL(n, \mathbb{R})$ we can construct a vector bundle E having $\{g_{\alpha\beta}\}$ as its cocycle as in (5.10). A homomorphism between two vector bundles, called a *bundle map*, is a fiber-preserving smooth map $f : E \rightarrow E'$ which is linear on corresponding fibers.

Exercise 6.2. Show that two vector bundles on M are isomorphic if and only if their cocycles relative to some open cover are equivalent.

Given a vector bundle with cocycle $\{g_{\alpha\beta}\}$, if it is possible to find an equivalent cocycle with values in a subgroup H of $GL(n, \mathbb{R})$, we say that *the structure group of E may be reduced to H* . A vector bundle is *orientable* if its structure group may be reduced to $GL^+(n, \mathbb{R})$, the linear transformations of \mathbb{R}^n with positive determinant. A trivialization $\{(U_\alpha, \phi_\alpha)\}_{\alpha \in I}$ on E is said to be *oriented* if for every α and β in I , the transition function $g_{\alpha\beta}$ has positive determinant. Two oriented trivializations $\{(U_\alpha, \phi_\alpha)\}, \{(V_\beta, \psi_\beta)\}$ are *equivalent* if for every x in $U_\alpha \cap V_\beta$, $\phi_\alpha \circ (\psi_\beta)^{-1}(x) : \mathbb{R}^n \rightarrow \mathbb{R}^n$ has positive determinant. It is easily checked that this is an equivalence relation and that it

partitions all the oriented trivializations of the vector bundle E into two equivalence classes. Either equivalence class is called an *orientation* on the vector bundle E .

EXAMPLE 6.3 (The tangent bundle). By attaching to each point x in a manifold M , the tangent space to M at x , we obtain the *tangent bundle* of M :

$$T_M = \bigcup_{x \in M} T_x M.$$

Let $\{(U_\alpha, \psi_\alpha)\}$ be an atlas for M . The diffeomorphism

$$\psi_\alpha : U_\alpha \xrightarrow{\sim} \mathbb{R}^n$$

induces a map

$$(\psi_\alpha)_* : T_{U_\alpha} \xrightarrow{\sim} T_{\mathbb{R}^n},$$

which gives a local trivialization of the tangent bundle T_M . From this we see that the transition functions of T_M are the Jacobians of the transition functions of M . Therefore M is orientable if and only if its tangent bundle is. If $\psi_\alpha = (x_1, \dots, x_n)$, then $\partial/\partial x_1, \dots, \partial/\partial x_n$ is a frame for T_M over U_α . In the language of bundles a smooth vector field on U_α is a smooth section of the tangent bundle over U_α .

We now show that the structure group of every real vector bundle E may be reduced to the orthogonal group. First, we can endow E with a Riemannian structure—a smoothly varying positive definite symmetric bilinear form on each fiber—as follows. Let $\{U_\alpha\}$ be an open cover of M which trivializes E . On each U_α , choose a frame for $E|_{U_\alpha}$ and declare it to be orthonormal. This defines a Riemannian structure on $E|_{U_\alpha}$. Let $\langle \cdot, \cdot \rangle_\alpha$ denote this inner product on $E|_{U_\alpha}$. Now use a partition of unity $\{\rho_\alpha\}$ to splice them together, i.e., form

$$\langle \cdot, \cdot \rangle = \sum \rho_\alpha \langle \cdot, \cdot \rangle_\alpha.$$

This will be an inner product over all of M .

As trivializations of E , we take only those maps ϕ_α that send orthonormal frames of E (relative to the global metric $\langle \cdot, \cdot \rangle$) to orthonormal frames of \mathbb{R}^n . Then the transition functions $g_{\alpha\beta}$ will preserve orthonormal frames and hence take values in the orthogonal group $O(n)$. If the determinant of $g_{\alpha\beta}$ is positive, $g_{\alpha\beta}$ will actually be in the special orthogonal group $SO(n)$. Thus

Proposition 6.4. *The structure group of a real vector bundle of rank n can always be reduced to $O(n)$; it can be reduced to $SO(n)$ if and only if the vector bundle is orientable.*

Exercise 6.5. (a) Show that there is a direct product decomposition

$$GL(n, \mathbb{R}) = O(n) \times \{\text{positive definite symmetric matrices}\}.$$

(b) Use (a) to show that the structure group of any real vector bundle may be reduced to $O(n)$ by finding the λ_α 's of Lemma 6.1.

Operations on Vector Bundles

Apart from introducing the functorial operations on vector bundles, our main purpose here is to establish the triviality of a vector bundle over a contractible manifold, a fact needed in the proof of the Thom isomorphism.

Functorial operations on vector spaces carry over to vector bundles. For instance, if E and E' are vector bundles over M of rank n and m respectively, their *direct sum* $E \oplus E'$ is the vector bundle over M whose fiber at the point x in M is $E_x \oplus E'_x$. The local trivializations $\{\phi_\alpha\}$ and $\{\phi'_\alpha\}$ for E and E' induce a local trivialization for $E \oplus E'$:

$$\phi_\alpha \oplus \phi'_\alpha : E \oplus E' |_{U_\alpha} \simeq U_\alpha \times (\mathbb{R}^n \oplus \mathbb{R}^m).$$

Hence the transition matrices for $E \oplus E'$ are

$$\begin{pmatrix} g_{\alpha\beta} & 0 \\ 0 & g'_{\alpha\beta} \end{pmatrix}.$$

Similarly we can define the tensor product $E \otimes E'$, the dual E^* , and $\text{Hom}(E, E')$. Note that $\text{Hom}(E, E')$ is isomorphic to $E^* \otimes E'$. The tensor product $E \otimes E'$ clearly has transition matrices $\{g_{\alpha\beta} \otimes g'_{\alpha\beta}\}$, but the transition matrices for the dual E^* are not so immediate. Recall that the dual V^* of a real vector space V is the space of all linear functionals on V , i.e., $V^* \simeq \text{Hom}(V, \mathbb{R})$, and that a linear map $f: V \rightarrow W$ induces a map $f^t: W^* \rightarrow V^*$ represented by the transpose of the matrix of f . If

$$\phi_\alpha : E |_{U_\alpha} \simeq U_\alpha \times \mathbb{R}^n$$

is a trivialization for E , then

$$(\phi'_\alpha)^{-1} : E^* |_{U_\alpha} \simeq U_\alpha \times (\mathbb{R}^n)^*$$

is a trivialization for E^* . Therefore the transition functions of E^* are

$$(6.6) \quad (\phi'_\alpha)^{-1} \phi'_\beta = ((\phi_\alpha \phi_\beta^{-1})^t)^{-1} = (g'_{\alpha\beta})^{-1}.$$

Let M and N be manifolds and $\pi: E \rightarrow M$ a vector bundle over M . Any map $f: N \rightarrow M$ induces a vector bundle $f^{-1}E$ on N , called the *pullback of E by f* . This bundle $f^{-1}E$ is defined to be the subset of $N \times E$ given by

$$\{(n, e) \mid f(n) = \pi(e)\}$$

It is the unique maximal subset of $N \times E$ which makes the following diagram commutative

$$\begin{array}{ccc}
 & \subset N \times E & \\
 f^{-1}E & \longrightarrow & E \\
 \downarrow & & \downarrow \pi \\
 N & \xrightarrow{f} & M.
 \end{array}$$

The fiber of $f^{-1}E$ over a point y in N is isomorphic to $E_{f(y)}$. Since a product bundle pulls back to a product bundle we see that $f^{-1}E$ is locally trivial, and is therefore a vector bundle. Furthermore, if we have a composition

$$M'' \xrightarrow{g} M' \xrightarrow{f} M,$$

then

$$(f \circ g)^{-1}E = g^{-1}(f^{-1}E).$$

Let $\text{Vect}_k(M)$ be the isomorphism classes of rank k real vector bundles over M . It is a pointed set with base point the isomorphism class of the product bundle over M . If $f : M \rightarrow N$ is a map between two manifolds, let $\text{Vect}_k(f) = f^{-1}$ be the pullback map on bundles. In this way, for each integer k , $\text{Vect}_k(\)$ becomes a functor from the category of manifolds and smooth maps to the category of pointed sets and base point preserving maps.

REMARK 6.7 Let $\{U_\alpha\}$ be a trivializing open cover for E and $g_{\alpha\beta}$ the transition functions. Then $\{f^{-1}U_\alpha\}$ is a trivializing open cover for $f^{-1}E$ over N and $(f^{-1}E)|_{f^{-1}U_\alpha} \cong f^{-1}(E|_{U_\alpha})$. Therefore the transition functions for $f^{-1}E$ are the pullback functions $f^*g_{\alpha\beta}$.

A basic property of the pullback is the following.

Theorem 6.8 (Homotopy Property of Vector Bundles). *Assume Y to be a compact manifold. If f_0 and f_1 are homotopic maps from Y to a manifold X and E is a vector bundle on X , then $f_0^{-1}E$ is isomorphic to $f_1^{-1}E$, i.e., homotopic maps induce isomorphic bundles.*

PROOF. The problem of constructing an isomorphism between two vector bundles V and W of rank k over a space B may be turned into a problem in cross-sectioning a fiber bundle over B , as follows. Recall that $\text{Hom}(V, W) = V^* \otimes W$ is a vector bundle over B whose fiber at each point p consists of all the linear maps from V_p to W_p . Define $\text{Iso}(V, W)$ to be the

subset of $\text{Hom}(V, W)$ whose fiber at each point consists of all the *isomorphisms* from V_p to W_p . (This is like looking at the complement of the zero section of a line bundle.) $\text{Iso}(V, W)$ inherits a topology from $\text{Hom}(V, W)$, and is a fiber bundle with fiber $GL(n, \mathbb{R})$. An isomorphism between V and W is simply a section of $\text{Iso}(V, W)$.

Let $f: Y \times I \rightarrow X$ be a homotopy between f_0 and f_1 , and let $\pi: Y \times I \rightarrow Y$ be the projection. Suppose for some t_0 in I , $f_{t_0}^{-1}E$ is isomorphic to some vector bundle F on Y . We will show that for all t near t_0 , $f_t^{-1}E \simeq F$. By the compactness of the unit interval I it will then follow that $f_t^{-1}E \simeq F$ for all t in I .

Over $Y \times I$ there are two pullback bundles, $f^{-1}E$ and $\pi^{-1}F$. Since $f_{t_0}^{-1}E \simeq F$, $\text{Iso}(f^{-1}E, \pi^{-1}F)$ has a section over $Y \times t_0$, which a priori is also a section of $\text{Hom}(f^{-1}E, \pi^{-1}F)$. Since Y is compact, $Y \times t_0$ may be covered with a finite number of trivializing open sets for $\text{Hom}(f^{-1}E, \pi^{-1}F)$ (see Figure 6.1). As the fiber of $\text{Hom}(f^{-1}E, \pi^{-1}F)$ are Euclidean spaces, the section over $Y \times t_0$ may be extended to a section of $\text{Hom}(f^{-1}E, \pi^{-1}F)$ over the union of these open sets. Now any linear map near an isomorphism remains an isomorphism; thus we can extend the given section of $\text{Iso}(f^{-1}E, \pi^{-1}F)$ to a strip containing $Y \times t_0$. This proves that $f_t^{-1}E \simeq F$ for t near t_0 . We now cover $Y \times I$ with a finite number of such strips. Hence $f_0^{-1}E \simeq F \simeq f_1^{-1}E$. \square

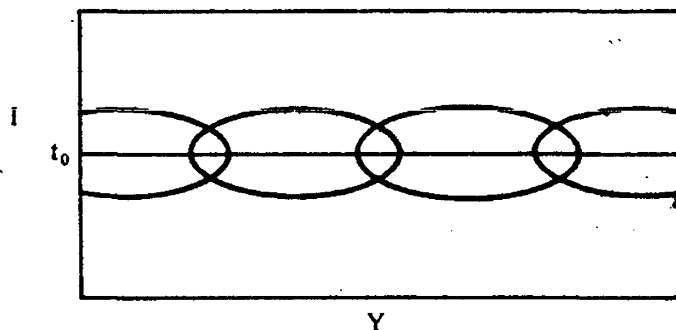

Figure 6.1

REMARK. If Y is not compact, we may not be able to find a strip of constant width over which $\text{Iso}(f^{-1}E, \pi^{-1}F)$ has a section; for example the strip may look like Figure 6.2.

But the same argument can be refined to give the theorem for Y a *paracompact space*. See, for instance, Husemoller [1, Theorem 4.7, p. 29]. Recall that Y is said to be *paracompact* if every open cover \mathcal{U} of Y has a *locally finite* open refinement \mathcal{U}' , that is, every point in Y has a neighborhood which meets only finitely many open sets in \mathcal{U}' . A compact space or a discrete space are clearly paracompact. By a theorem of A. H. Stone, so is every metric space (Dugundji [1, p. 186]). More importantly for us, every manifold is paracompact (Spivak [1, Ch. 2, Th. 13, p. 66]). Thus the homotopy

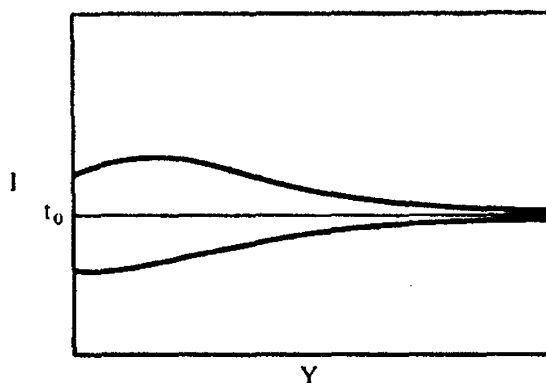

Figure 6.2

property of vector bundles (Theorem 6.8) actually holds over any manifold Y , compact or not.

Corollary 6.9. *A vector bundle over a contractible manifold is trivial.*

PROOF. Let E be a vector bundle over M and let f and g be maps

$$M \xrightarrow{f} \text{point}$$

such that $g \circ f$ is homotopic to the identity 1_M . By the homotopy property of vector bundles

$$E \simeq (g \circ f)^{-1}E \simeq f^{-1}(g^{-1}E).$$

Since $g^{-1}E$ is a vector bundle on a point, it is trivial, hence so is $f^{-1}(g^{-1}E)$. □

So for a contractible manifold M , $\text{Vect}_k(M)$ is a single point.

REMARK. Although all the results in this subsection are stated in the differentiable category of manifolds and smooth maps, the corresponding statements with “manifold” replaced by “space” also hold in the continuous category of topological spaces and continuous maps, the only exception being Corollary 6.9, in which the space should be assumed paracompact.

Exercise 6.10. Compute $\text{Vect}_k(S^1)$.

Compact Cohomology of a Vector Bundle

The Poincaré lemmas

$$H^*(M \times \mathbb{R}^n) = H^*(M)$$

$$H_c^*(M \times \mathbb{R}^n) = H_c^{*-n}(M)$$

may be viewed as results on the cohomology of the trivial bundle $M \times \mathbb{R}^n$ over M . More generally let E be a vector bundle of rank n over M . The zero section of E , $s : x \mapsto (x, 0)$, embeds M diffeomorphically in E . Since $M \times \{0\}$ is a deformation retract of E , it follows from the homotopy axiom for de Rham cohomology (Corollary 4.1.2.2) that

$$H^*(E) \simeq H^*(M).$$

For cohomology with compact support one may suspect that

$$(6.11) \quad H_c^*(E) \simeq H_c^{* - n}(M).$$

This is in general not true; the open Möbius strip, considered as a vector bundle over S^1 , provides a counterexample, since the compact cohomology of the Möbius strip is identically zero (Exercise 4.8). However, if E and M are orientable manifolds of finite type, then formula (6.11) holds. The proof is based on Poincaré duality, as follows. Let m be the dimension of M . Then

$$\begin{aligned} H_c^*(E) &\simeq (H^{m+n-*}(E))^* \text{ by Poincaré duality on } E \\ &\simeq (H^{m+n-*}(M))^* \text{ by the homotopy axiom for de Rham cohomology} \\ &\simeq H_c^{* - n}(M) \text{ by Poincaré duality on } M. \end{aligned}$$

Lemma 6.12. *An orientable vector bundle E over an orientable manifold M is an orientable manifold.*

PROOF. This follows from the fact that if $\{(U_\alpha, \psi_\alpha)\}$ is an oriented atlas for M with transition functions $h_{\alpha\beta} = \psi_\alpha \circ \psi_\beta^{-1}$ and

$$\phi_\alpha : E|_{U_\alpha} \simeq U_\alpha \times \mathbb{R}^n$$

is a local trivialization for E with transition functions $g_{\alpha\beta}$, then the composition

$$E|_{U_\alpha} \simeq U_\alpha \times \mathbb{R}^n \simeq \mathbb{R}^m \times \mathbb{R}^n$$

gives an atlas for E . The typical transition function of this atlas,

$$(\psi_\alpha \times 1) \circ \phi_\alpha \phi_\beta^{-1} \circ (\psi_\beta^{-1} \times 1) : \mathbb{R}^m \times \mathbb{R}^n \rightarrow \mathbb{R}^m \times \mathbb{R}^n$$

sends (x, y) to $(h_{\alpha\beta}(x), g_{\alpha\beta}(\psi_\alpha^{-1}(x))y)$ and has Jacobian matrix

$$(6.12.1) \quad \begin{pmatrix} D(h_{\alpha\beta}) & * \\ 0 & g_{\alpha\beta}(\psi_\alpha^{-1}(x)) \end{pmatrix},$$

where $D(h_{\alpha\beta})$ is the Jacobian matrix of $h_{\alpha\beta}$. The determinant of the matrix (6.12.1) is clearly positive. \square

Thus,

Proposition 6.13. *If $\pi : E \rightarrow M$ is an orientable vector bundle and M is orientable, then $H_c^*(E) \simeq H_c^{* - n}(M)$.*

REMARK 6.13.1. Actually the orientability assumption on M is superfluous. See Exercise 6.20.

REMARK 6.13.2. Let M be an oriented manifold with oriented atlas $\{(U_\alpha, \psi_\alpha)\}$ and $\pi: E \rightarrow M$ an oriented vector bundle over M with orientation $\{(U_\alpha, \phi_\alpha)\}$. Then E can be made into an oriented manifold with orientation given by the oriented atlas

$$\{\pi^{-1}(U_\alpha), (\psi_\alpha \times 1) \circ \phi_\alpha : \pi^{-1}(U_\alpha) \rightarrow U_\alpha \times \mathbb{R}^n \rightarrow \mathbb{R}^m \times \mathbb{R}^n\}.$$

This is called the *local product orientation* on E .

Compact Vertical Cohomology and Integration along the Fiber

As mentioned earlier, for vector bundles there is a third kind of cohomology. Instead of $\Omega_c^*(E)$, the complex of forms with compact support, we consider $\Omega_{cv}^*(E)$, the complex of forms with compact support *in the vertical direction*; in other words, a form in $\Omega_{cv}^*(E)$ need not have compact support in E but its restriction to each fiber has compact support. The cohomology of this complex, denoted $H_{cv}^*(E)$, is called *the cohomology of E with compact support in the vertical direction*, or *compact vertical cohomology*.

Let E be oriented as a rank n vector bundle. The formulas in (4.4) extend to this situation to give integration along the fiber, $\pi_* : \Omega_{cv}^*(E) \rightarrow \Omega^{*-n}(M)$, as follows. First consider the case of a trivial bundle $E = M \times \mathbb{R}^n$. Let t_1, \dots, t_n be the coordinates on the fiber \mathbb{R}^n . A form on E is a real linear combination of two types of forms: the type (I) forms are those which do not contain as a factor the n -form $dt_1 \dots dt_n$, and the type (II) forms are those which do. The map π_* is defined by

$$\begin{aligned} \text{(I)} \quad (\pi^*\phi)f(x, t_1, \dots, t_n) dt_{i_1} \dots dt_{i_r} &\mapsto 0, \quad r < n \\ \text{(II)} \quad (\pi^*\phi)f(x, t_1, \dots, t_n) dt_1 \dots dt_n &\mapsto \phi \int_{\mathbb{R}^n} f(x, t_1, \dots, t_n) dt_1 \dots dt_n, \end{aligned}$$

where f has compact support for each fixed x in M and ϕ is a form on M . Next suppose E is an arbitrary oriented vector bundle, with oriented trivialization $\{(U_\alpha, \phi_\alpha)\}_{\alpha \in I}$. Let x_1, \dots, x_m and y_1, \dots, y_m be the coordinate functions on U_α and U_β , and $t_1, \dots, t_n, u_1, \dots, u_n$ the fiber coordinates on $E|_{U_\alpha}$ and $E|_{U_\beta}$, given by ϕ_α and ϕ_β respectively. Because $\{(U_\alpha, \phi_\alpha)\}$ is an oriented trivialization for E , the two sets of fiber coordinates t_1, \dots, t_n and u_1, \dots, u_n are related by an element of $GL^+(n, \mathbb{R})$ at each point of $U_\alpha \cap U_\beta$. Again a form ω in $\Omega_{cv}^*(E)$ is locally of type (I) or (II). The map π_* is defined to be zero on type (I) forms. To define π_* on type (II) forms, write ω_α for $\omega|_{\pi^{-1}(U_\alpha)}$. Then

$$\omega_\alpha = (\pi^*\phi)f(x_1, \dots, x_m, t_1, \dots, t_n) dt_1 \dots dt_n$$

and

$$\omega_\beta = (\pi^*\tau)g(y_1, \dots, y_m, u_1, \dots, u_n) du_1 \dots du_n.$$

Define

$$\pi_* \omega_\alpha = \phi \int_{\mathbb{R}^n} f(x, t) dt_1 \dots dt_n.$$

Exercise 6.14. Show that if E is an oriented vector bundle, then $\pi_* \omega_\alpha = \pi_* \omega_\beta$. Hence $\{\pi_* \omega_\alpha\}_{\alpha \in 1}$ piece together to give a global form $\pi_* \omega$ on M . Furthermore, this definition is independent of the choice of the oriented trivialization for E .

Proposition 6.14.1. *Integration along the fiber π_* commutes with exterior differentiation d .*

PROOF. Let $\{(U_\alpha, \phi_\alpha)\}$ be a trivialization for \bar{E} , $\{\rho_\alpha\}$ a partition of unity subordinate to $\{U_\alpha\}$, and ω a form in $\Omega_{c_0}^*(E)$. Since $\omega = \sum \rho_\alpha \omega$, and both π_* and d are linear, it suffices to prove the proposition for $\rho_\alpha \omega$, that is, $\pi_* d(\rho_\alpha \omega) = d\pi_*(\rho_\alpha \omega)$. Thus from the outset we may assume E to be the product bundle $M \times \mathbb{R}^n$. If $\omega = (\pi^* \phi) f(x, t) dt_1 \dots dt_n$ is a type (II) form,

$$\begin{aligned} d\pi_* \omega &= d(\phi \int f(x, t) dt_1 \dots dt_n) \\ &= (d\phi) \int f(x, t) dt_1 \dots dt_n + (-1)^{\deg \phi} \phi \sum_i dx_i \int \frac{\partial f}{\partial x_i}(x, t) dt_1 \dots dt_n \end{aligned}$$

and

$$\begin{aligned} \pi_* d\omega &= \pi_* ((\pi^* d\phi) f dt_1 \dots dt_n + (-1)^{\deg \phi} \pi^* \phi \sum \frac{\partial f}{\partial x_i} dx_i dt_1 \dots dt_n) \\ &= (d\phi) \int f dt_1 \dots dt_n + (-1)^{\deg \phi} \sum_i \phi dx_i \int \frac{\partial f}{\partial x_i} dt_1 \dots dt_n. \end{aligned}$$

So $d\pi_* \omega = \pi_* d\omega$ for a type (II) form. Next let $\omega = (\pi^* \phi) f(x, t) dt_1 \dots dt_r$, $r < n$, be a type (I) form. Then

$$d\pi_* \omega = 0$$

and

$$\begin{aligned} \pi_* d\omega &= (-1)^{\deg \phi} \sum_i \pi_* ((\pi^* \phi) \frac{\partial f}{\partial t_i}(x, t) dt_i dt_1 \dots dt_r) \\ &= 0 \quad \text{if } dt_i dt_1 \dots dt_r \neq \pm dt_1 \dots dt_n. \end{aligned}$$

If $dt_i dt_1 \dots dt_r = \pm dt_1 \dots dt_n$, then $\int \frac{\partial f}{\partial t_i}(x, t) dt_i dt_1 \dots dt_r$ is again 0: because f has compact support,

$$\int_{-\infty}^{\infty} \frac{\partial f}{\partial t_i}(x, t) dt_i = f(\dots, \infty, \dots) - f(\dots, -\infty, \dots) = 0. \quad \square$$

Note that integration along the fiber, $\pi_* : \Omega^*(E) \rightarrow \Omega^{*-n}(M)$ lowers the degree of a form by the fiber dimension.

Proposition 6.15 (Projection Formula). (a) *Let $\pi : E \rightarrow M$ be an oriented rank n vector bundle, τ a form on M and ω a form on E with compact support along the fiber. Then*

$$\pi_*((\pi^*\tau) \cdot \omega) = \tau \cdot \pi_* \omega.$$

(b) *Suppose in addition that M is oriented of dimension m , $\omega \in \Omega_{cv}^n(E)$, and $\tau \in \Omega_c^{m+n-q}(M)$. Then with the local product orientation on E*

$$\int_E (\pi^*\tau) \wedge \omega = \int_M \tau \wedge \pi_* \omega.$$

PROOF. (a) Since two forms are the same if and only if they are the same locally, we may assume that E is the product bundle $M \times \mathbb{R}^n$. If ω is a form of type (I), say $\omega = \pi^*\phi \cdot f(x, t) dt_{i_1} \dots dt_{i_r}$, where $r < n$, then

$$\pi_*((\pi^*\tau) \cdot \omega) = \pi_*((\pi^*(\tau \phi) \cdot f(x, t) dt_{i_1} \dots dt_{i_r})) = 0 = \tau \cdot \pi_* \omega.$$

If ω is a form of type (II), say $\omega = \pi^*\phi \cdot f(x, t) dt_1 \dots dt_n$, then

$$\pi_*((\pi^*\tau) \cdot \omega) = \tau \phi \int_{\mathbb{R}^n} f(x, t) dt_1 \dots dt_n = \tau \cdot \pi_* \omega.$$

(b) Let $\{(U_\alpha, \phi_\alpha)\}_{\alpha \in J}$ be an oriented trivialization for E and $\{\rho_\alpha\}_{\alpha \in J}$ a partition of unity subordinate to $\{U_\alpha\}$. Writing $\omega = \sum \rho_\alpha \omega$, where $\rho_\alpha \omega$ has support in U_α , we have

$$\int_E (\pi^*\tau) \wedge \omega = \sum_\alpha \int_{E_{U_\alpha}} (\pi^*\tau) \wedge (\rho_\alpha \omega)$$

and

$$\int_M \tau \wedge \pi_* \omega = \sum_\alpha \int_{U_\alpha} \tau \wedge \pi_*(\rho_\alpha \omega).$$

Here $\tau \wedge \pi_*(\rho_\alpha \omega)$ has compact support because its support is a closed subset of the compact set $\text{Supp } \tau$; similarly, $(\pi^*\tau) \wedge (\rho_\alpha \omega)$ also has compact support. Therefore, it is enough to prove the proposition for $M = U_\alpha$ and E trivial. The rest of the proof proceeds as in (a). \square

The proof of the Poincaré lemma for compact supports (4.7) carries over verbatim to give

Proposition 6.16 (Poincaré Lemma for Compact Vertical Supports). *Integration along the fiber defines an isomorphism*

$$\pi_* : H_{cv}^*(M \times \mathbb{R}^n) \rightarrow H^{*-n}(M).$$

This is a special case of

Theorem 6.17 (Thom Isomorphism). *If the vector bundle $\pi : E \rightarrow M$ over a manifold M of finite type is orientable, then*

$$H_{cv}^*(E) \simeq H^{*-n}(M)$$

where n is the rank of E .

PROOF. Let U and V be open subsets of M . Using a partition of unity from the base M we see that

$$0 \rightarrow \Omega_{cv}^*(E|_{U \cup V}) \rightarrow \Omega_{cv}^*(E|_U) \oplus \Omega_{cv}^*(E|_V) \rightarrow \Omega_{cv}^*(E|_{U \cap V}) \rightarrow 0$$

is exact, as in (2.3). So we have the diagram of Mayer-Vietoris sequences

$$\begin{array}{ccccccc} \cdots & \longrightarrow & H_{cv}^*(E|_{U \cup V}) & \longrightarrow & H_{cv}^*(E|_U) \oplus H_{cv}^*(E|_V) & \longrightarrow & H_{cv}^*(E|_{U \cap V}) & \xrightarrow{d^*} & H_{cv}^{*+1}(E|_{U \cup V}) & \longrightarrow & \cdots \\ & & \downarrow \pi_* & & \downarrow \pi_* & & \downarrow \pi_* & & \downarrow \pi_* & & \\ \cdots & \longrightarrow & H^{*-n}(U \cup V) & \longrightarrow & H^{*-n}(U) \oplus H^{*-n}(V) & \longrightarrow & H^{*-n}(U \cap V) & \xrightarrow{d^*} & H^{*+1-n}(U \cup V) & \longrightarrow & \cdots \end{array}$$

The commutativity of this diagram is trivial for the first two squares; we will check that of the third. Recalling from (2.5) the explicit formula for the coboundary operator d^* , we have by the projection formula (6.15)

$$\pi_* d^* \omega = \pi_* ((\pi^* d\rho_U) \cdot \omega) = (d\rho_U) \cdot \pi_* \omega = d^* \pi_* \omega.$$

So the diagram in question is commutative.

By (6.9) if U is diffeomorphic to \mathbb{R}^n , then $E|_U$ is trivial, so that in this case the Thom isomorphism reduces to the Poincaré lemma for compact vertical supports (6.16). Hence in the diagram above, π_* is an isomorphism for contractible open sets. By the Five Lemma if the Thom isomorphism holds for U , V , and $U \cap V$, then it holds for $U \cup V$. The proof now proceeds by induction on the cardinality of a good cover for the base, as in the proof of Poincaré duality. This gives the Thom isomorphism for any manifold M having a finite good cover. \square

REMARK 6.17.1. Although the proof above works only for a manifold of finite type, the theorem is actually true for any base space. We will prove the theorem for an arbitrary manifold in (12.2.2).

Under the Thom isomorphism $\mathcal{F} : H^*(M) \simeq H_{cv}^{*+n}(E)$, the image of 1 in $H^0(M)$ determines a cohomology class Φ in $H_{cv}^n(E)$, called the *Thom class* of the oriented vector bundle E . Because $\pi_* \Phi = 1$, by the projection formula (6.15)

$$\pi_*(\pi^* \omega \wedge \Phi) = \omega \wedge \pi_* \Phi = \omega.$$

So the Thom isomorphism, which is inverse to π_* , is given by

$$\mathcal{F}(\omega) = \pi^*(\omega) \wedge \Phi.$$

Proposition 6.18. *The Thom class Φ on a rank n oriented vector bundle E can be uniquely characterized as the cohomology class in $H_{cv}^n(E)$ which restricts to the generator of $H_c^n(F)$ on each fiber F .*

PROOF. Since $\pi_* \Phi = 1$, $\Phi|_{\text{fiber}}$ is a bump form on the fiber with total integral 1. Conversely if Φ' in $H_{cv}^n(E)$ restricts to a generator on each fiber, then

$$\pi_*(\pi^* \omega \wedge \Phi') = \omega \wedge \pi_* \Phi' = \omega.$$

Hence $\pi^*(\) \wedge \Phi'$ must be the Thom isomorphism \mathcal{F} and $\Phi' = \mathcal{F}(1)$ is the Thom class. \square

Proposition 6.19. *If E and F are two oriented vector bundles over a manifold M , and π_1 and π_2 are the projections*

$$\begin{array}{ccc} & E \oplus F & \\ \pi_1 \swarrow & & \searrow \pi_2 \\ E & & F \end{array} ,$$

then the Thom class of $E \oplus F$ is $\Phi(E \oplus F) = \pi_1^* \Phi(E) \wedge \pi_2^* \Phi(F)$.

PROOF. Let $m = \text{rank } E$ and $n = \text{rank } F$. Then $\pi_1^* \Phi(E) \wedge \pi_2^* \Phi(F)$ is a class in $H_c^{m+n}(E \oplus F)$ whose restriction to each fiber is a generator of the compact cohomology of the fiber, since the isomorphism

$$H_c^{m+n}(\mathbb{R}^m \times \mathbb{R}^n) \simeq H_c^m(\mathbb{R}^m) \otimes H_c^n(\mathbb{R}^n)$$

is given by the wedge product of the generators. \square

Exercise 6.20. Using a Mayer-Vietoris argument as in the proof of the Thom isomorphism (Theorem 6.17), show that if $\pi : E \rightarrow M$ is an orientable rank n bundle, then

$$H_c^*(E) \simeq H_c^{*-n}(M).$$

Note that this is Proposition 6.13 with the orientability assumption on M removed.

Poincaré Duality and the Thom Class

Let S be a closed oriented submanifold of dimension k in an oriented manifold M of dimension n . Recall from (5.13) that the Poincaré dual of S is the cohomology class of the closed $(n - k)$ -form η_S characterized by the property

$$(6.21) \quad \int_S \omega = \int_M \omega \wedge \eta_S$$

for any closed k -form with compact support on M . In this section we will explain how the Poincaré dual of a submanifold relates to the Thom class of a bundle (Proposition 6.24). To this end we first introduce the notion of a *tubular neighborhood* of S in M ; this is, by definition an open neighborhood of S in M diffeomorphic to a vector bundle of rank $n - k$ over S . Now a sequence of vector bundles over M ,

$$0 \rightarrow E \rightarrow E' \rightarrow E'' \rightarrow 0,$$

is said to be *exact* if at each point p in M , the sequence of vector spaces

$$0 \rightarrow E_p \rightarrow E'_p \rightarrow E''_p \rightarrow 0$$

is exact, where E_p is the fiber of E at p . If S is a submanifold in M , the *normal bundle* $N = N_{S/M}$ of S in M is the vector bundle on S defined by the exact sequence

$$(6.22) \quad 0 \rightarrow T_S \rightarrow T_M|_S \rightarrow N \rightarrow 0,$$

where $T_M|_S$ is the restriction of the tangent bundle of M to S . The tubular neighborhood theorem states that every submanifold S in M has a tubular neighborhood T , and that in fact T is diffeomorphic to the normal bundle of S in M (see Spivak [1, p. 465] or Guillemin and Pollack [1, p. 76]). For example, if S is a curve in \mathbb{R}^3 , then a tubular neighborhood of S may be constructed using the metric in \mathbb{R}^3 by attaching to each point of S an open disc of radius one perpendicular to S at the center. The union of all these discs is a tubular neighborhood of S (Figure 6.3(a)).

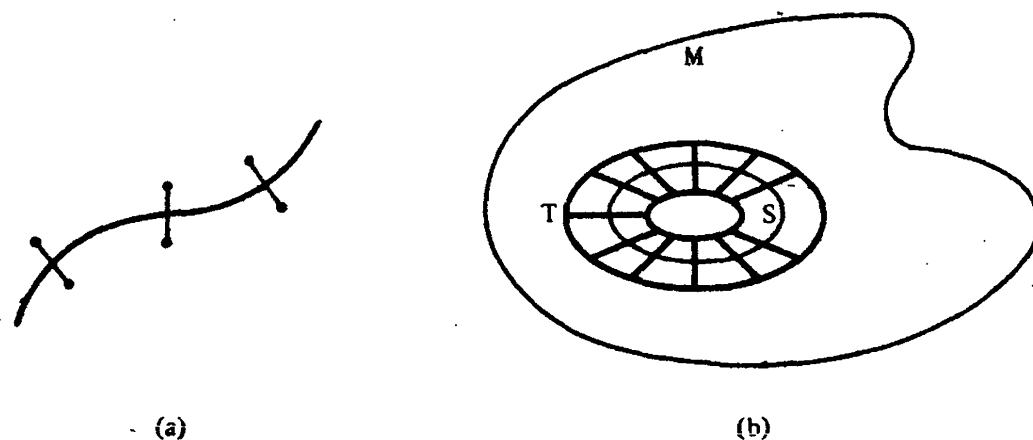

Figure 6.3

In general if A and B are two oriented vector bundles with oriented trivializations $\{(U_\alpha, \phi_\alpha)\}$ and $\{(U_\alpha, \psi_\alpha)\}$, respectively, then the *direct sum orientation* on $A \oplus B$ is given by the oriented trivialization $\{(U_\alpha, \phi_\alpha \oplus \psi_\alpha)\}$. Returning to our submanifold S in M , we let $j: T \hookrightarrow M$ be the inclusion of a tubular neighborhood T of S in M (see Figure 6.3(b)). Since S and M are orientable, the normal bundle N_S , being the quotient of $T_M|_S$ by T_S , is also orientable. By convention it is oriented in such a way that

$$N_S \oplus T_S = T_M|_S$$

has the direct sum orientation. So the Thom isomorphism theorem applies to the normal bundle $T = N_S$ over S and we have the sequence of maps

$$H^*(S) \xrightarrow{\hat{\Phi}} H^{*+s-k}(T) \xrightarrow{j_*} H^{*+s-k}(M)$$

where $\hat{\Phi}$ is the Thom class of the tube T and j_* is extension by 0; here j_* is defined because we are only concerned with forms on the tubular neighborhood T which vanish near the boundary of T . We claim that *the Poincaré*

dual of S is the Thom class of the normal bundle of S ; more precisely

$$(6.23) \quad \eta_S = j_*(\Phi \wedge 1) = j_* \Phi \quad \text{in } H^{n-k}(M).$$

To prove this we merely have to show that $j_* \Phi$ satisfies the defining property (5.13) of the Poincaré dual η_S . Let ω be any closed k -form with compact support on M , and $i: S \rightarrow T$ the inclusion, regarded as the zero section of the bundle $\pi: T \rightarrow S$. Since π is a deformation retraction of T onto S , π^* and i^* are inverse isomorphisms in cohomology. Therefore on the level of forms, ω and $\pi^*i^*\omega$ differ by an exact form: $\omega = \pi^*i^*\omega + d\tau$.

$$\begin{aligned} \int_M \omega \wedge j_* \Phi &= \int_T \omega \wedge \Phi && \text{because } j_* \Phi \text{ has support in } T \\ &= \int_T (\pi^*i^*\omega + d\tau) \wedge \Phi \\ &= \int_T (\pi^*i^*\omega) \wedge \Phi && \text{since } \int_T (d\tau) \wedge \Phi = \int_T d(\tau \wedge \Phi) = 0 \text{ by Stokes' theorem} \\ &= \int_S i^*\omega \wedge \pi_* \Phi && \text{by the projection formula (6.15)} \\ &= \int_S i^*\omega && \text{because } \pi_* \Phi = 1. \end{aligned}$$

This concludes the proof of the claim. Note that if S is compact, then its Poincaré dual $\eta_S = j_* \Phi$ has compact support.

Conversely, suppose E is an oriented vector bundle over an oriented manifold M . Then M is diffeomorphically embedded as the zero section in E and there is an exact sequence

$$0 \rightarrow T_M \rightarrow (T_E)|_M \rightarrow E \rightarrow 0,$$

i.e., the normal bundle of M in E is E itself. By (6.23), the Poincaré dual of M in E is the Thom class of E . In summary,

Proposition 6.24. (a) *The Poincaré dual of a closed oriented submanifold S in an oriented manifold M and the Thom class of the normal bundle of S can be represented by the same forms.*

(b) *The Thom class of an oriented vector bundle $\pi: E \rightarrow M$ over an oriented manifold M and the Poincaré dual of the zero section of E can be represented by the same form.*

Because the normal bundle of the submanifold S in M is diffeomorphic to any tubular neighborhood of S , we have the following proposition.

Proposition 6.25 (Localization Principle). *The support of the Poincaré dual of a submanifold S can be shrunk into any given tubular neighborhood of S .*

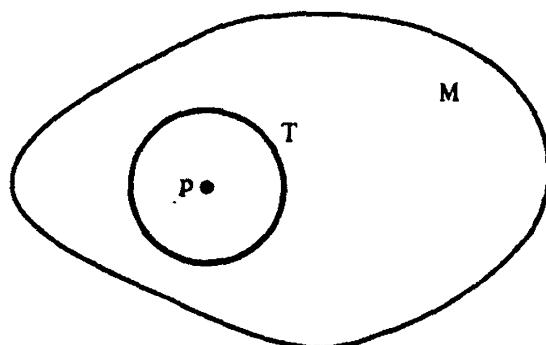

Figure 6.4

EXAMPLE 6.26.

(a) *The Poincaré dual of a point p in M .*

A tubular neighborhood T of p is simply an open ball around p (Figure 6.4). A generator of $H_{co}^n(T)$ is a bump n -form with total integral 1. So the Poincaré dual of a point is a bump n -form on M . The form need not have support at p since all bump n -forms on a connected manifold are cohomologous.

(b) *The Poincaré dual of M .*

Here the tubular neighborhood T is M itself, and $H_{co}^n(T) = H^n(M)$. So the Poincaré dual of M is the constant function 1.

(c) *The Poincaré dual of a circle on a torus.*

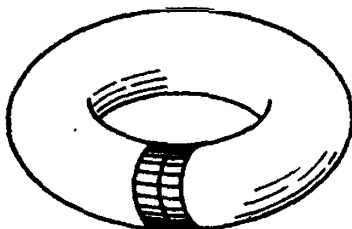

Figure 6.5

The Poincaré dual is a bump 1-form with support in a tubular neighborhood of the circle and with total integral 1 on each fiber of the tubular neighborhood (Figure 6.5). In the usual representation of the torus as a square, if the circle is a vertical segment, then its Poincaré dual is $\rho(x) dx$ where ρ is a bump function with total integral 1 (Figure 6.6).

Using the explicit construction of the Poincaré dual $\eta_S = j_* \Phi$ as the Thom class of the normal bundle, we now prove two basic properties of Poincaré duality. Two submanifolds R and S in M are said to *intersect transversally* if and only if

$$(6.27) \quad T_x R + T_x S = T_x M$$

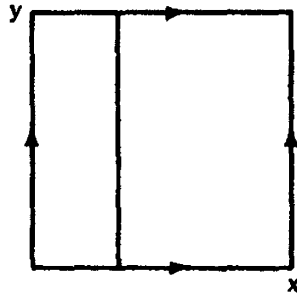

Figure 6.6

at all points x in the intersection $R \cap S$ (Guillemin and Pollack [1, pp. 27–32]). For such a transversal intersection the codimension in M is additive:

$$(6.28) \quad \text{codim } R \cap S = \text{codim } R + \text{codim } S.$$

This implies that the normal bundle of $R \cap S$ in M is

$$(6.29) \quad N_{R \cap S} = N_R \oplus N_S.$$

Assume M to be an oriented manifold, and R and S to be closed oriented submanifolds. Denoting the Thom class of an oriented vector bundle E by $\Phi(E)$, we have by (6.19)

$$(6.30) \quad \Phi(N_{R \cap S}) = \Phi(N_R \oplus N_S) = \Phi(N_R) \wedge \Phi(N_S).$$

Therefore,

$$(6.31) \quad \eta_{R \cap S} = \eta_R \wedge \eta_S;$$

i.e., under Poincaré duality the transversal intersection of closed oriented submanifolds corresponds to the wedge product of forms.

If $f: M' \rightarrow M$ is an orientation-preserving map of oriented manifolds, T is a tubular neighborhood of the closed oriented submanifold S in M , and $f(M')$ is transversal to S and T , then $f^{-1}T$ is a tubular neighborhood of $f^{-1}S$ in M' . From the commutative diagram

$$\begin{array}{ccccc} H^*(S) & \xrightarrow{\Phi(T)} & H_{cv}^{*+k}(T) & \xrightarrow{I_*} & H^*(M) \\ f^* \downarrow & & f^* \downarrow & & f^* \downarrow \\ H^*(f^{-1}S) & \xrightarrow{\Phi(f^{-1}T)} & H_{cv}^{*+k}(f^{-1}T) & \xrightarrow{I_*} & H^*(M') \end{array}$$

we see that if ω is the cohomology class on M representing the submanifold S in M , then $f^*\omega$ is the cohomology class on M' representing $f^{-1}(S)$, i.e., under Poincaré duality the induced map on cohomology corresponds to the pre-image in geometry, i.e., $\eta_{f^{-1}(S)} = f^*\eta_S$.

The Global Angular Form, the Euler Class, and the Thom Class

In this subsection we will construct explicitly the Thom class of an oriented rank 2 vector bundle $\pi : E \rightarrow M$, using such data as a partition of unity on M and the transition functions of E . The higher-rank case is similar but more involved, and will be taken up in (11.11) and (12.3). The construction is best understood as the vector-bundle analogue of the procedure for going from a generator of $H^{n-1}(S^{n-1}) = H^{n-1}(\mathbb{R}^n - \{0\})$ to a generator of $H_c^n(\mathbb{R}^n)$. So let us first try to understand the situation in \mathbb{R}^n .

We will call a top form on an oriented manifold M *positive* if it is in the orientation class of M . The standard orientation on the unit sphere S^{n-1} in \mathbb{R}^n is by convention the following one: if σ is a generator of $H^{n-1}(S^{n-1})$ and $\pi : \mathbb{R}^n - \{0\} \rightarrow S^{n-1}$ is a deformation retraction, then σ is positive on S^{n-1} if and only if $d\mathbf{r} \cdot \pi^*\sigma$ is positive on $\mathbb{R}^n - \{0\}$.

Exercise 6.32. (a) Show that if θ is the standard angle function on \mathbb{R}^2 , measured in the counterclockwise direction, then $d\theta$ is positive on the circle S^1 .

(b) Show that if ϕ and θ are the spherical coordinates on \mathbb{R}^3 as in Figure 6.7, then $d\phi \wedge d\theta$ is positive on the 2-sphere S^2 .

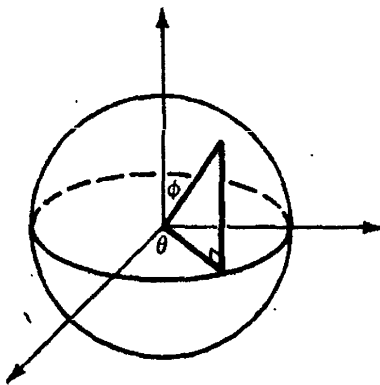

Figure 6.7

Let σ be the positive generator of $H^{n-1}(S^{n-1})$ and $\psi = \pi^*\sigma$ the corresponding generator of $H^{n-1}(\mathbb{R}^n - \{0\})$; ψ is called the *angular form* on $\mathbb{R}^n - \{0\}$. If $\rho(r)$ is the function of the radius shown in Figure 6.8, then $d\rho = \rho'(r)dr$ is a bump form on \mathbb{R}^1 with total integral 1 (Figure 6.9). Therefore $(d\rho) \cdot \psi$ is a compactly supported form on \mathbb{R}^n with total integral 1, i.e., $(d\rho) \cdot \psi$ is the generator of $H_c^n(\mathbb{R}^n)$. Note that because ψ is closed, we can write

$$(6.33) \quad (d\rho) \cdot \psi = d(\rho \cdot \psi).$$

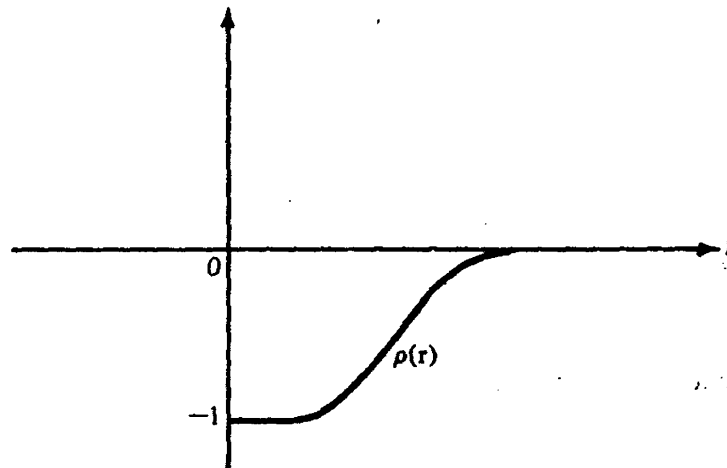

Figure 6.8

Now let E be an oriented rank n vector bundle over M , and E^0 the complement of the zero section in E . Endow E with a Riemannian structure as in (6.4) so that the radius function r makes sense on E . We begin our construction of the Thom class by finding a global form ψ on E^0 whose restriction to each fiber is the angular form on $\mathbb{R}^n - \{0\}$. ψ is called the *global angular form*. Once we have the angular form ψ , it is then easy to check that $\Phi = d(\rho \cdot \psi)$ is the Thom class.

Now suppose the rank of E is 2, and $\{U_\alpha\}$ is an open cover of M . Since E has a Riemannian structure, over each U_α we can choose an orthonormal frame. This defines on $E^0|_{U_\alpha}$ polar coordinates r_α and θ_α ; if x_1, \dots, x_n are coordinates on U_α , then $\pi^*x_1, \dots, \pi^*x_n, r_\alpha, \theta_\alpha$ are coordinates on $E^0|_{U_\alpha}$. On the overlap $U_\alpha \cap U_\beta$, the radii r_α and r_β are equal but the angular coordinates θ_α and θ_β differ by a rotation. By the orientability of E , it makes sense to speak of the "counterclockwise direction" in each fiber. This allows

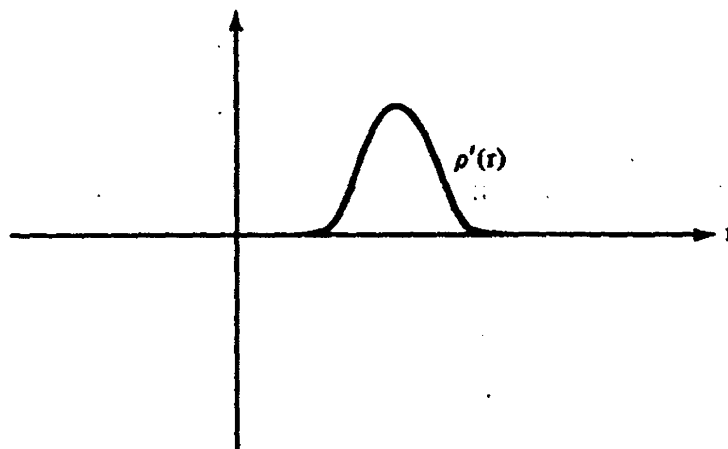

Figure 6.9

us to define unambiguously $\varphi_{\alpha\beta}$ as the angle of rotation in the counterclockwise direction from the α -coordinate system to the β -coordinate system:

$$(6.34) \quad \theta_\beta = \theta_\alpha + \pi^* \varphi_{\alpha\beta}, \quad 0 \leq \varphi_{\alpha\beta} < 2\pi.$$

Although rotating from α to β and then from β to γ is the same as rotating from α to γ , it is not true that $\varphi_{\alpha\beta} + \varphi_{\beta\gamma} - \varphi_{\alpha\gamma} = 0$; indeed all that one can say is

$$\varphi_{\alpha\beta} + \varphi_{\beta\gamma} - \varphi_{\alpha\gamma} \in 2\pi\mathbb{Z}.$$

ASIDE. To each triple intersection we can associate an integer

$$(6.35) \quad \varepsilon_{\alpha\beta\gamma} = \frac{1}{2\pi} (\varphi_{\alpha\beta} - \varphi_{\alpha\gamma} + \varphi_{\beta\gamma}).$$

The collection of integers $\{\varepsilon_{\alpha\beta\gamma}\}$ measures the extent to which $\{\varphi_{\alpha\beta}\}$ fails to be a cocycle. We will give another interpretation of $\{\varepsilon_{\alpha\beta\gamma}\}$ in Section 11.

Unlike the functions $\{\varphi_{\alpha\beta}\}$, the 1-forms $\{d\varphi_{\alpha\beta}\}$ satisfy the cocycle condition.

Exercise 6.36. There exist 1-forms ξ_α on U_α such that

$$\frac{1}{2\pi} d\varphi_{\alpha\beta} = \xi_\beta - \xi_\alpha.$$

[Hint: Take $\xi_\alpha = \sum_\gamma \rho_\gamma d\varphi_{\alpha\gamma}$, where $\{\rho_\gamma\}$ is a partition of unity subordinate to $\{U_\gamma\}$.]

It follows from Exercise 6.36 that $d\xi_\alpha = d\xi_\beta$ on $U_\alpha \cap U_\beta$. Hence the $d\xi_\alpha$ piece together to give a global 2-form e on M . This global form e is clearly closed. It is not necessarily exact since the ξ_α do not usually piece together to give a global 1-form. The cohomology class of e in $H^2(M)$ is called the *Euler class* of the oriented vector bundle E . We sometimes write $e(E)$ instead of e .

Claim. *The cohomology class of e is independent of the choice of ξ in our construction.*

PROOF OF CLAIM. If $\{\bar{\xi}_\alpha\}$ is a different choice of 1-forms such that

$$\frac{1}{2\pi} d\varphi_{\alpha\beta} = \bar{\xi}_\beta - \bar{\xi}_\alpha = \xi_\beta - \xi_\alpha,$$

then

$$\bar{\xi}_\beta - \xi_\beta = \bar{\xi}_\alpha - \xi_\alpha = \xi$$

is a global form. So $d\bar{\xi}_\alpha$ and $d\xi_\alpha$ differ by an exact global form. \square

By (6.34) and (6.36), on $E^0|_{U_\alpha \cap U_\beta}$,

$$(6.36.1) \quad \frac{d\theta_\alpha}{2\pi} - \pi^* \xi_\alpha = \frac{d\theta_\beta}{2\pi} - \pi^* \xi_\beta.$$

These forms then piece together to give a global 1-form ψ on E^0 , the *global angular form*, whose restriction to each fiber is the angular form $(1/2\pi) d\theta$, i.e., if $\iota_p : \mathbb{R}^2 \rightarrow E$ is the orthogonal inclusion of a fiber over p , then $\iota_p^* \psi = (1/2\pi) d\theta$. The global angular form is not closed:

$$d\psi = d\left(\frac{d\theta_\alpha}{2\pi} - \pi^* \xi_\alpha\right) = -\pi^* d\xi_\alpha = -\pi^* d\xi_\beta.$$

Therefore,

$$(6.37) \quad d\psi = -\pi^* e.$$

When E is a product, ψ could be taken to be the pullback of $(1/2\pi) d\theta$ under the projection $E^0 = M \times (\mathbb{R}^2 - 0) \rightarrow \mathbb{R}^2 - 0$. In this case ψ is closed and e is 0. The Euler class is in this sense a measure of the twisting of the oriented vector bundle E .

The Euler class of an oriented rank 2 vector bundle may be given in terms of the transition functions, as follows. Let $g_{\alpha\beta} : U_\alpha \cap U_\beta \rightarrow \text{SO}(2)$ be the transition functions of E . By identifying $\text{SO}(2)$ with the unit circle in the complex plane via $\begin{pmatrix} \cos \theta & -\sin \theta \\ \sin \theta & \cos \theta \end{pmatrix} = e^{i\theta}$, $g_{\alpha\beta}$ may be thought of as complex-valued functions. In this context the angle from the β -coordinate system to the α -coordinate system is $(1/i)\log g_{\alpha\beta}$. Thus

$$\theta_\alpha - \theta_\beta = \pi^*(1/i)\log g_{\alpha\beta},$$

and

$$\pi^* d\varphi_{\alpha\beta} = -\pi^*(1/i)\log g_{\alpha\beta}.$$

Since the projection π has maximal rank, π^* is injective, so that

$$d\varphi_{\alpha\beta} = -(1/i)\log g_{\alpha\beta}.$$

Let $\{\rho_\gamma\}$ be a partition of unity subordinate to $\{U_\gamma\}$. Then

$$\frac{1}{2\pi} d\varphi_{\alpha\beta} = \xi_\beta - \xi_\alpha,$$

where

$$(6.37.1) \quad \xi_\alpha = \frac{1}{2\pi} \sum_\gamma \rho_\gamma d\varphi_{\gamma\alpha} = -\frac{1}{2\pi i} \sum_\gamma \rho_\gamma d \log g_{\gamma\alpha}.$$

Therefore,

$$(6.38) \quad e(E) = -\frac{1}{2\pi i} \sum_\gamma d(\rho_\gamma d \log g_{\gamma\alpha}) \quad \text{on } U_\alpha.$$

Proposition 6.39. *The Euler class is functorial, i.e., if $f : N \rightarrow M$ is a C^∞ map and E is a rank 2 oriented vector bundle over M , then*

$$e(f^{-1}E) = f^* e(E).$$

PROOF. Since the transition functions of $f^{-1}E$ are $f^*g_{\alpha\beta}$, the proposition is an immediate consequence of (6.38). \square

We claim that just as in the untwisted case (6.33), the Thom class is the cohomology class of

$$(6.40) \quad \Phi = d(\rho(r) \cdot \psi) = d\rho(r) \cdot \psi - \rho(r)\pi^*e.$$

Although ψ is defined only outside the zero section of E , the form Φ is a global form on E since $d\rho \equiv 0$ near the zero section. Φ has the following properties:

- (a) compact support in the vertical direction;
- (b) closed: $d\Phi = -d\rho(r) \cdot d\psi - d\rho(r)\pi^*e = 0$;
- (c) restriction to each fiber has total integral 1:

$$\pi_* \iota_p^* \Phi = \int_0^\infty \int_0^{2\pi} d\rho(r) \cdot \frac{d\theta}{2\pi} = \rho(\infty) - \rho(0) = 1,$$

where $\iota_p : E_p \rightarrow E$ is the inclusion of the fiber E_p into E ;

(d) the cohomology class of Φ is independent of the choice of $\rho(r)$. Suppose $\bar{\rho}(r)$ is another function of r which is -1 near 0 and 0 near infinity, and which defines $\bar{\Phi}$. Then

$$\Phi - \bar{\Phi} = d((\rho(r) - \bar{\rho}(r)) \cdot \psi)$$

where $(\rho(r) - \bar{\rho}(r)) \cdot \psi$ is a global form on E because $\rho(r) - \bar{\rho}(r)$ vanishes near the zero section.

Therefore Φ indeed defines the Thom class. Furthermore, if $s : M \rightarrow E$ is the zero section of E , then

$$s^*\Phi = d(\rho(0)) \cdot s^*\psi - \rho(0)s^*\pi^*e = e.$$

This proves

Proposition 6.41. *The pullback of the Thom class to M by the zero section is the Euler class.*

Let $\{U_\alpha\}$ be a trivializing cover for E , $\{\rho_\alpha\}$ a partition of unity subordinate to $\{U_\alpha\}$, and $g_{\alpha\beta}$ the transition functions for E . Since

$$\begin{aligned}\psi &= \frac{d\theta_\alpha}{2\pi} - \pi^* d\xi_\alpha \\ &= \frac{d\theta_\alpha}{2\pi} + \frac{1}{2\pi i} \pi^* \sum_\gamma \rho_\gamma d \log g_{\gamma\alpha}.\end{aligned}$$

(cf. (6.36.1) and (6.37.1)), we have by (6.40),

$$(6.42) \quad \Phi = d\left(\rho(r) \frac{d\theta_\alpha}{2\pi}\right) + \frac{1}{2\pi i} d(\rho(r)\pi^* \sum_\gamma \rho_\gamma d \log g_{\gamma\alpha}).$$

This is the explicit formula for the Thom class.

Exercise 6.43. Let $\pi : E \rightarrow M$ be an oriented rank 2 bundle. As we saw in the proof of the Thom isomorphism, wedging with the Thom class is an isomorphism $\wedge \Phi : H^*(M) \simeq H_{cv}^{*+2}(E)$. Therefore every cohomology class on E is the wedge product of Φ with the pullback of a cohomology class on M . Find the class u on M such that

$$\Phi^2 = \Phi \wedge \pi^* u \text{ in } H_{cv}^*(E).$$

Exercise 6.44. The complex projective space CP^n is the space of all lines through the origin in C^{n+1} , topologized as the quotient of C^{n+1} by the equivalence relation

$$z \sim \lambda z \text{ for } z \in C^{n+1}, \lambda \text{ a nonzero complex number.}$$

Let z_0, \dots, z_n be the complex coordinates on C^{n+1} . These give a set of homogeneous coordinates $[z_0, \dots, z_n]$ on CP^n , determined up to multiplication by a nonzero complex number λ . Define U_i to be the open subset of CP^n given by $z_i \neq 0$. $\{U_0, \dots, U_n\}$ is called the standard open cover of CP^n .

(a) Show that CP^n is a manifold.

(b) Find the transition functions of the normal bundle N_{CP^1/CP^2} relative to the standard open cover of CP^1 .

EXAMPLE 6.44.1. (The Euler class of the normal bundle of CP^1 in CP^2). Let $N = N_{CP^1/CP^2}$ be the normal bundle of CP^1 in CP^2 . Since CP^1 is a compact oriented manifold of real dimension 2, its top-dimensional cohomology is $H^2(CP^1) = \mathbb{R}$. We will find the Euler class $e(N)$ as a multiple of the generator in $H^2(CP^1)$.

By Exercise 6.44 the transition function of N relative to the standard open cover is $g_{01} = z_0/z_1$ at the point $[z_0, z_1]$. Let $z = z_0/z_1$ be the coordinate of U_1 , which we identify with the complex plane C . By (6.38) the Euler

class $e(N)$ on U_1 is given by

$$\begin{aligned} e(N) &= -\frac{1}{2\pi i} d\rho_0 d \log g_{01} \\ &= -\frac{1}{2\pi i} d\rho_0 d \log z, \end{aligned}$$

where ρ_0 is 1 in a neighborhood of the origin, and 0 in a neighborhood of infinity.

Fix a circle C in the complex plane with so large a radius that $\text{Supp } \rho_0$ is contained inside C . Let A_r be the annulus centered at the origin whose outer circle is C and whose inner circle B_r has radius r (Figure 6.10). Note that as the boundary of A_r , the circle C is oriented counterclockwise while B_r is oriented clockwise.

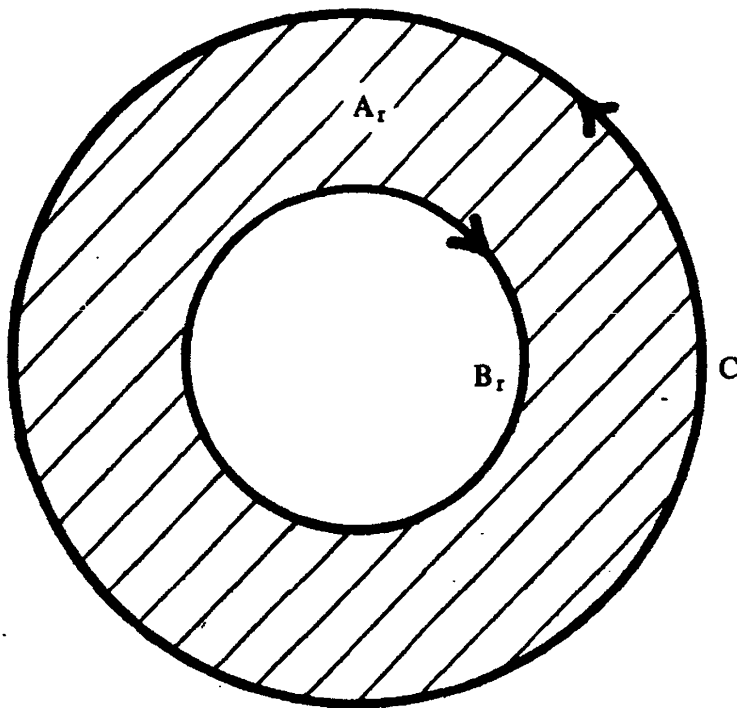

Figure 6.10

Now

$$\int_{\mathbb{C}P^1} e(N) = -\frac{1}{2\pi i} \int_C d\rho_0 d \log z,$$

and

$$\begin{aligned} \int_{\mathcal{C}} d(\rho_0 dz/z) &= \lim_{r \rightarrow 0} \int_{A_r} d(\rho_0 dz/z) \\ &= \lim_{r \rightarrow 0} \int_{\mathcal{C}} \rho_0 dz/z + \int_{B_r} \rho_0 dz/z && \text{by Stokes' theorem} \\ &= \lim_{r \rightarrow 0} \int_{B_r} dz/z \\ &= -2\pi i, \end{aligned}$$

where the minus sign is due to the clockwise orientation on B_r . Therefore,

$$\int_{\mathbb{C}P^1} e(N) = -\frac{1}{2\pi i} (-2\pi i) = 1.$$

Exercise 6.45. On the complex projective space $\mathbb{C}P^n$ there is a tautological line bundle S , called the *universal subbundle*; it is the subbundle of the product bundle $\mathbb{C}P^n \times \mathbb{C}^{n+1}$ given by

$$S = \{(\ell, z) \mid z \in \ell\}.$$

Above each point ℓ in $\mathbb{C}P^n$, the fiber of S is the line represented by ℓ . Find the transition functions of the universal subbundle S of $\mathbb{C}P^1$ relative to the standard open cover and compute its Euler class.

Exercise 6.46. Let S^n be the unit sphere in \mathbb{R}^{n+1} and i the antipodal map on S^n :

$$i: (x_1, \dots, x_{n+1}) \rightarrow (-x_1, \dots, -x_{n+1}).$$

The *real projective space* $\mathbb{R}P^n$ is the quotient of S^n by the equivalence relation

$$x \sim i(x), \quad \text{for } x \in \mathbb{R}^{n+1}.$$

(a) An *invariant form* on S^n is a form ω such that $i^*\omega = \omega$. The vector space of invariant forms on S^n , denoted $\Omega^*(S^n)^I$, is a differential complex, and so the invariant cohomology $H^*(S^n)^I$ of S^n is defined. Show that $H^*(\mathbb{R}P^n) \simeq H^*(S^n)^I$.

(b) Show that the natural map $H^*(S^n)^I \rightarrow H^*(S^n)$ is injective. [Hint: If ω is an invariant form and $\omega = d\tau$ for some form τ on S^n , then $\omega = d(\tau + i^*\tau)/2$.]

(c) Give S^n its standard orientation (p. 70). Show that the antipodal map $i: S^n \rightarrow S^n$ is orientation-preserving for n odd and orientation-reversing for n even. Hence, if $[\sigma]$ is a generator of $H^n(S^n)$, then $[\sigma]$ is an invariant cohomology class if and only if n is odd.

(d) Show that the de Rham cohomology of $\mathbb{R}P^n$ is

$$H^q(\mathbb{R}P^n) = \begin{cases} \mathbb{R} & \text{for } q = 0, \\ 0 & \text{for } 0 < q < n, \\ \mathbb{R} & \text{for } q = n \text{ odd,} \\ 0 & \text{for } q = n \text{ even.} \end{cases}$$

Relative de Rham Theory

The Thom class of an oriented vector bundle may be viewed as a *relative* cohomology class, which we now define. Let $f : S \rightarrow M$ be a map between two manifolds. Define a complex $\Omega^*(f) = \bigoplus_{q \geq 0} \Omega^q(f)$ by

$$\begin{aligned} \Omega^q(f) &= \Omega^q(M) \oplus \Omega^{q-1}(S), \\ d(\omega, \theta) &= (d\omega, f^*\omega - d\theta). \end{aligned}$$

It is easily verified that $d^2 = 0$. Note that a cohomology class in $\Omega^*(f)$ is represented by a closed form ω on M which becomes exact when pulled back to S .

By definition we have the exact sequence

$$0 \rightarrow \Omega^{q-1}(S) \xrightarrow{\alpha} \Omega^q(f) \xrightarrow{\beta} \Omega^q(M) \rightarrow 0$$

with the obvious maps α and $\beta : \alpha(\theta) = (0, \theta)$ and $\beta(\omega, \theta) = \omega$. Clearly β is a chain map but α is not quite a chain map; in fact it anticommutes with d $\alpha d = -d\alpha$. In any case there is still a long exact sequence in cohomology

$$(6.47) \quad \dots \rightarrow H^{q-1}(S) \xrightarrow{\alpha^*} H^q(f) \xrightarrow{\beta^*} H^q(M) \xrightarrow{\delta^*} H^q(S) \rightarrow \dots$$

Claim 6.48. $\delta^* = f^*$.

PROOF OF CLAIM. Consider the diagram

$$\begin{array}{ccccccc} 0 & \rightarrow & \Omega^q(S) & \rightarrow & \Omega^{q+1}(f) & \rightarrow & \Omega^{q+1}(M) \rightarrow 0 \\ & & d \uparrow & & d \uparrow & & d \uparrow \\ 0 & \rightarrow & \Omega^{q-1}(S) & \rightarrow & \Omega^q(f) & \rightarrow & \Omega^q(M) \rightarrow 0 \\ & & & & \omega & & \omega \\ & & & & (\omega, \theta) & & \omega \end{array}$$

Let $\omega \in \Omega^q(M)$ be a closed form and (ω, θ) any element of $\Omega^q(f)$ which maps to ω . Then $d(\omega, \theta) = (0, f^*\omega - d\theta)$. So $\delta^*[\omega] = [f^*\omega - d\theta] = [f^*\omega]$. \square

Combining (6.47) and (6.48) we have

Proposition 6.49. *Let $f : S \rightarrow M$ be a differentiable map between two manifolds. Then there is an exact sequence*

$$\cdots \rightarrow H^q(f) \xrightarrow{\beta^*} H^q(M) \xrightarrow{f^*} H^q(S) \xrightarrow{\alpha^*} H^{q+1}(f) \rightarrow \cdots$$

Exercise 6.50. If $f, g : S \rightarrow M$ are homotopic maps, show that $H^*(f)$ and $H^*(g)$ are isomorphic algebras.

If S is a submanifold of M and $i : S \rightarrow M$ is the inclusion map, we define the *relative de Rham cohomology* $H^q(M, S)$ to be $H^q(i)$.

We now turn to the Thom class. Recall that if $\pi : E \rightarrow M$ is a rank n oriented vector bundle and E^0 is the complement of the zero section, then there is a global angular form ψ on E^0 such that $d\psi = -\pi^*e$, where e represents the Euler class of E (6.37). Furthermore, if $s : M \rightarrow E$ is the zero section, then $e = s^*\Phi$ (Proposition 6.41). Hence, $(s \circ \pi)^*\Phi = -d\psi$, where $s \circ \pi : E^0 \rightarrow E$. This shows that $(\Phi, -\psi)$ is closed in the complex $\Omega^*(s \circ \pi)$ and so represents a class in $H^n(s \circ \pi)$. Since the map $s \circ \pi : E^0 \rightarrow E$ is clearly homotopic to the inclusion $i : E^0 \rightarrow E$, by Exercise 6.50, $H^n(s \circ \pi) = H^n(i)$. Hence, $(\Phi, -\psi)$ represents a class in the relative cohomology $H^n(E, E^0)$.

§7 The Nonorientable Case

Since the integral of a differential form on \mathbb{R}^n is not invariant under the whole group of diffeomorphisms of \mathbb{R}^n , but only under the subgroup of orientation-preserving diffeomorphisms, a differential form cannot be integrated over a nonorientable manifold. However, by modifying a differential form we obtain something called a *density*, which can be integrated over any manifold, orientable or not. This will give us a version of Poincaré duality for nonorientable manifolds and of the Thom isomorphism for nonorientable vector bundles.

The Twisted de Rham Complex

- Let M be a manifold and E a vector space. The space of *differential forms on M with values in E* , denoted $\Omega^*(M, E)$, is by definition the vector space spanned by $\omega \otimes v$, where $\omega \in \Omega^*(M)$, $v \in E$, and the tensor product is over \mathbb{R} . This space can be made naturally into a differential complex if we let the differential be

$$d(\omega \otimes v) = (d\omega) \otimes v.$$

So the cohomology $H^*(M, E)$ is defined. Indeed, if E is a vector space of dimension n , then $H^*(M, E)$ is isomorphic to n copies of $H_{\mathbb{R}}^*(M)$.

Now let E be a vector bundle. We define the space of E -valued q -forms, $\Omega^q(M, E)$, to be the global sections of the vector bundle $(\Lambda^q T_M^*) \otimes E$. Locally such a q -form can be written as $\sum \omega_i \otimes e_i$, where ω_i are q -forms and e_i are sections of E over some open set U in M , and the tensor product is over the C^∞ functions on U . For these vector-valued differential forms, no natural extension of the de Rham complex is possible, unless one is first given a way of differentiating the sections of E .

Suppose the vector bundle E has a trivialization $\{(U_\alpha, \phi_\alpha)\}$ relative to which the transition functions are locally constant. Such a vector bundle is called a *flat vector bundle* and the trivialization a *locally constant trivialization*. For a flat vector bundle E a differential operator on $\Omega^*(M, E)$ may be defined as follows. Let $e_\alpha^1, \dots, e_\alpha^n$ be the sections of E over U_α corresponding to the standard basis under the trivialization $\phi_\alpha: E|_{U_\alpha} \simeq U_\alpha \times \mathbb{R}^n$. We declare these to be the *standard locally constant sections*, i.e., $de_\alpha^i = 0$. Over U_α an E -valued q -form s in $\Omega^q(M, E)$ can be written as $\sum \omega_i \otimes e_\alpha^i$, where the ω_i are q -forms over U_α . We define the exterior derivative ds over U_α by linearity and the Leibnitz rule:

$$d(\sum \omega_i \otimes e_\alpha^i) = \sum (d\omega_i) \otimes e_\alpha^i.$$

It is easy to show that, because the transition functions of E relative to $\{(U_\alpha, \phi_\alpha)\}$ are locally constant, this definition of exterior differentiation is independent of the open sets U_α . More precisely, on the overlap $U_\alpha \cap U_\beta$, if

$$s = \sum \omega_i \otimes e_\alpha^i = \sum \tau_j \otimes e_\beta^j$$

and $e_\alpha^i = \sum c_{ij} e_\beta^j$, where the c_{ij} are locally constant functions, then

$$\tau_j = \sum c_{ij} \omega_i$$

and

$$\begin{aligned} d(\sum \tau_j \otimes e_\beta^j) &= \sum (d\tau_j) \otimes e_\beta^j \\ &= \sum (c_{ij} d\omega_i) \otimes e_\beta^j \\ &= \sum (d\omega_i) \otimes e_\alpha^i \\ &= d(\sum \omega_i \otimes e_\alpha^i). \end{aligned}$$

Hence ds is globally defined and is an element of $\Omega^{q+1}(M, E)$. Because d^2 is clearly zero, $\Omega^*(M, E)$ is a differential complex and the cohomology $H^*(M, E)$ makes sense. As defined, d very definitely depends on the trivialization $\{(U_\alpha, \phi_\alpha)\}$, for it is through the trivialization that the locally constant sections are given. Hence, d , $\Omega^*(M, E)$, and $H^*(M, E)$ are more properly denoted as d_ϕ , $\Omega_\phi^*(M, E)$, and $H_\phi^*(M, E)$.

EXAMPLE 7.1 (Two trivializations of a vector bundle E which give rise to distinct cohomology groups $H^*(M, E)$).

Let M be the circle S^1 and E the trivial line bundle $S^1 \times \mathbb{R}^1$ over the circle. If E is given the usual constant trivialization ϕ :

$$\phi(x, r) = r \quad \text{for } x \in S^1 \quad \text{and} \quad r \in \mathbb{R}^1,$$

then the cohomology $H_\phi^0(S^1, E) = \mathbb{R}$.

However, we can define another locally constant trivialization ψ for E as follows. Cover S^1 with two open sets U and V as indicated in Figure 7.1.

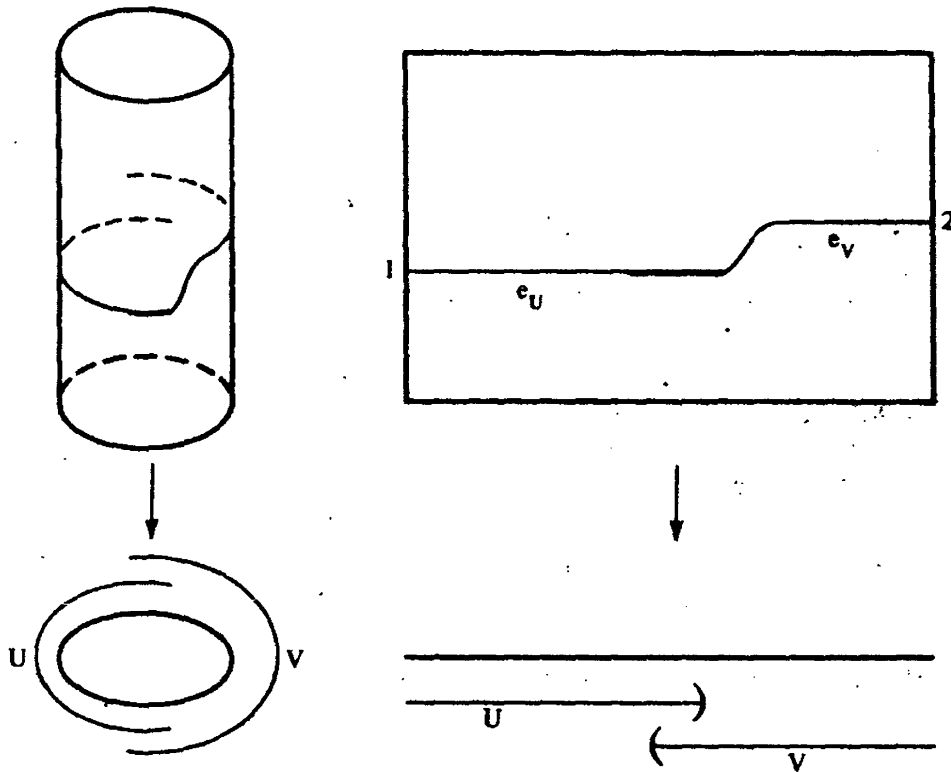

Figure 7.1

Let $\rho(x)$ be the real-valued function on V whose graph is as in Figure 7.2. The trivialization ψ is given by

$$\psi(x, r) = \begin{cases} r & \text{for } x \in U, r \in \mathbb{R}^1, \\ \rho(x)r & \text{for } x \in V, r \in \mathbb{R}^1. \end{cases}$$

The standard locally constant sections over U and V are $e_U(x) = (x, 1)$ and $e_V(x) = (x, 1/\rho(x))$ respectively. Relative to the trivialization ψ , the cohomology $H_\psi^0(S^1, E) = 0$, since the locally constant sections over U and V do not piece together to form a global section (except for the zero section).

It is natural to ask: to what extent is the twisted cohomology $H_\psi^*(M, E)$ independent of the trivialization ϕ for E ?

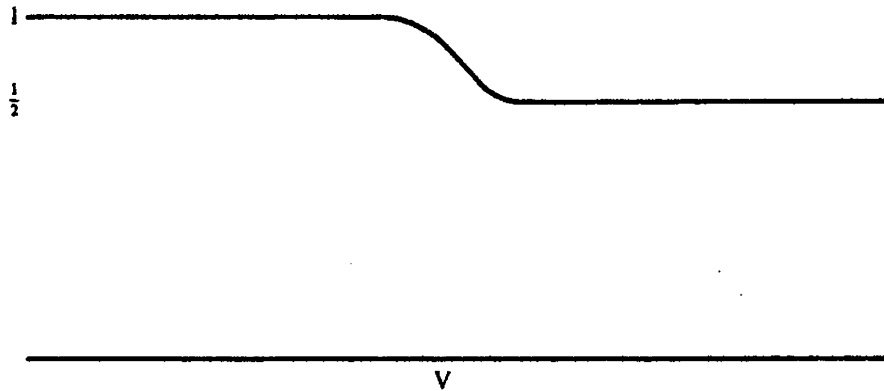

Figure 7.2

Proposition 7.2. *The twisted cohomology is invariant under the refinement of open covers. More precisely, let $\{(U_\alpha, \phi_\alpha)\}_{\alpha \in I}$ be a locally constant trivialization for E . Suppose $\{V_\beta\}_{\beta \in J}$ is a refinement of $\{U_\alpha\}_{\alpha \in I}$ and the coordinates maps ψ_β on $V_\beta \subset U_\alpha$ are the restrictions of ϕ_α . Then the two twisted complexes $\Omega_\phi^*(M, E)$ and $\Omega_\psi^*(M, E)$ are identical and so are their cohomology:*

$$H_\phi^*(M, E) = H_\psi^*(M, E).$$

PROOF. Since the definition of the differential operator on a twisted complex is local, and ϕ and ψ agree on the open cover $\{V_\beta\}$, we have $d_\phi = d_\psi$. Therefore the two complexes $\Omega_\phi^*(M, E)$ and $\Omega_\psi^*(M, E)$ are identical. \square

Still assuming E to be a flat vector bundle, suppose $\{(U_\alpha, \phi_\alpha)\}$ and $\{(U_\alpha, \psi_\alpha)\}$ are two locally constant trivializations which differ by a locally constant comparison 0-cochain, i.e., if e_α^i and f_α^j are the standard locally constant sections over U_α relative to the trivializations ϕ and ψ respectively, then

$$e_\alpha^i = \sum_j a_\alpha^{ij} f_\alpha^j$$

for some locally constant function

$$a_\alpha = (a_\alpha^{ij}): U_\alpha \rightarrow GL(n, \mathbb{R}).$$

In this case there is an obvious isomorphism

$$F: \Omega_\phi^*(M, E) \rightarrow \Omega_\psi^*(M, E)$$

given by

$$e_\alpha^i \mapsto \sum_j a_\alpha^{ij} f_\alpha^j.$$

It is easily checked that the diagram

$$\begin{array}{ccc} \Omega_\phi^*(M, E) & \xrightarrow{d_\phi} & \Omega_\phi^{*+1}(M, E) \\ \downarrow F & & \downarrow F \\ \Omega_\psi^*(M, E) & \xrightarrow{d_\psi} & \Omega_\psi^{*+1}(M, E) \end{array}$$

commutes. Hence F induces an isomorphism in cohomology. Next, suppose we are given two locally constant trivializations $\{(U_\alpha, \phi_\alpha)\}$ and $\{(V_\beta, \psi_\beta)\}$ for E , with possibly different open covers. By taking a common refinement, which does not affect the twisted cohomology (Proposition 7.2), we may assume that the two open covers are identical. The discussion above therefore proves the following.

Proposition 7.3. (a) *Let E be a flat vector bundle over M , and $\{(U_\alpha, \phi_\alpha)\}$ and $\{(V_\beta, \psi_\beta)\}$ two locally constant trivializations for E . Suppose after a common refinement the two trivializations differ by a locally constant comparison 0-cochain. Then there are isomorphisms*

$$\Omega_\phi^*(M, E) \simeq \Omega_\psi^*(M, E)$$

and

$$H_\phi^*(M, E) \simeq H_\psi^*(M, E).$$

This proposition may also be stated in terms of the transition functions for E .

Proposition 7.3. (b) *Let E be a flat vector bundle of rank n and $\{g_{\alpha\beta}\}$ and $\{h_{\alpha\beta}\}$ the transition functions for E relative to two locally constant trivializations ϕ and ψ with the same open cover. If there exist locally constant functions*

$$\lambda_\alpha: U_\alpha \rightarrow GL(n, \mathbb{R})$$

such that

$$g_{\alpha\beta} = \lambda_\alpha h_{\alpha\beta} \lambda_\beta^{-1},$$

then there are isomorphisms as in 7.3(a).

Proposition 7.4. *If E is a trivial rank n vector bundle over a manifold M , with ϕ a trivialization of E given by n global sections, then*

$$H_\phi^*(M, E) = H^*(M, \mathbb{R}^n) = \bigoplus_{i=1}^n H^*(M).$$

PROOF. Let e_1, \dots, e_n be the n global sections corresponding to the standard basis of \mathbb{R}^n . Then every element in $\Omega^*(M, E)$ can be written uniquely as $\sum \omega_i \otimes e_i$, where $\omega_i \in \Omega^*(M)$ and the tensor product is over the C^∞ functions on M . The map

$$\sum \omega_i \otimes e_i \mapsto (\omega_1, \dots, \omega_n)$$

gives an isomorphism of the complexes $\Omega_\phi^*(M, E)$ and $\Omega^*(M, \mathbb{R}^n)$. \square

Now let $\{(U_\alpha, \phi_\alpha)\}$ be a coordinate open cover for the manifold M , with transition functions $g_{\alpha\beta} = \phi_\alpha \circ \phi_\beta^{-1}$. Define the *sign function* on \mathbb{R}^1 to be

$$\text{sgn}(x) = \begin{cases} +1 & \text{for } x \text{ positive} \\ 0 & \text{for } x = 0 \\ -1 & \text{for } x \text{ negative.} \end{cases}$$

The *orientation bundle* of M is the line bundle L on M given by transition functions $\text{sgn } J(g_{\alpha\beta})$, where $J(g_{\alpha\beta})$ is the Jacobian determinant of the matrix of partial derivatives of $g_{\alpha\beta}$. It follows directly from the definition that M is *orientable if and only if its orientation bundle is trivial*.

Relative to the atlas $\{(U_\alpha, \phi_\alpha)\}$ for M with transition functions $g_{\alpha\beta}$, the orientation bundle is by definition the quotient

$$(U_\alpha \times \mathbb{R}^1)/(x, v) \sim (x, \text{sgn } J(g_{\alpha\beta}(x))v),$$

where $(x, v) \in U_\alpha \times \mathbb{R}^1$ and $(x, \text{sgn } J(g_{\alpha\beta}(x))v) \in U_\beta \times \mathbb{R}^1$. By construction there is a natural trivialization ϕ' on L ,

$$\phi'_\alpha: L|_{U_\alpha} \cong U_\alpha \times \mathbb{R}^1,$$

which we call *the trivialization induced from the atlas $\{(U_\alpha, \phi_\alpha)\}$ on M* . Because $\text{sgn } J(g_{\alpha\beta})$ are locally constant functions on M , the locally constant sections of L relative to this trivialization are the equivalence classes of $\{(x, v) | x \in U_\alpha\}$ for v fixed in \mathbb{R}^1 .

Proposition 7.5. *If ϕ' and ψ' are two trivializations for L induced from two atlases ϕ and ψ on M , then the two twisted complexes $\Omega_\downarrow^\bullet(M, L)$ and $\Omega_\uparrow^\bullet(M, L)$ are isomorphic and so are their cohomology $H_\downarrow^\bullet(M, L)$ and $H_\uparrow^\bullet(M, L)$.*

PROOF. By going to a common refinement we may assume that the two atlases ϕ and ψ have the same open cover. Thus on each U_α there are two sets of coordinate functions, ϕ_α and ψ_α (Figure 7.3).

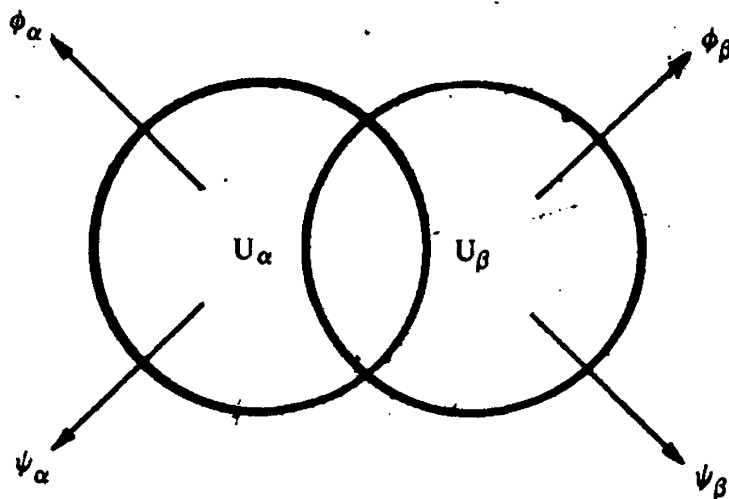

Figure 7.3

The transition functions $g_{\alpha\beta}$ and $h_{\alpha\beta}$ for the two atlases ϕ and ψ respectively are related by

$$\begin{aligned} g_{\alpha\beta}(x) &= \phi_\alpha \phi_\beta^{-1} \Big|_{\{x\} \times \mathbb{R}^1} \\ &= \phi_\alpha \psi_\alpha^{-1} \psi_\alpha \psi_\beta^{-1} \psi_\beta \phi_\beta^{-1} \Big|_{\{x\} \times \mathbb{R}^1} \\ &= \mu_\alpha(x) h_{\alpha\beta}(x) \mu_\beta(x), \end{aligned}$$

where $\mu_\alpha: U_\alpha \cap U_\beta \rightarrow \text{GL}(1, \mathbb{R})$ is the function

$$\mu_\alpha(x) = \phi_\alpha \psi_\alpha^{-1} \Big|_{\{x\} \times \mathbb{R}^1}.$$

It follows that

$$\text{sgn } J(g_{\alpha\beta}) = \text{sgn } J(\mu_\alpha) \cdot \text{sgn } J(h_{\alpha\beta}) \cdot \text{sgn } J(\mu_\beta)^{-1}.$$

Since $\text{sgn } J(\mu_\alpha) = \pm 1$, by Proposition 7.3(b)

$$\Omega_{\phi}^*(M, L) \simeq \Omega_{\psi}^*(M, L). \quad \square$$

We define the *twisted de Rham complex* $\Omega^*(M, L)$ and the *twisted de Rham cohomology* $H^*(M, L)$ to be $\Omega_{\phi}^*(M, L)$ and $H_{\phi}^*(M, L)$ for any trivialization ϕ' on L which is induced from M . Similarly one also has the *twisted de Rham cohomology with compact support*, $H_c^*(M, L)$.

REMARK. If a trivialization ψ on L is not induced from M , then $H_{\psi}^*(M, L)$ may not be equal to the twisted de Rham cohomology $H^*(M, L)$.

The following statement is an immediate consequence of Proposition 7.4 and the triviality of L on an orientable manifold.

Proposition 7.6. *On an orientable manifold M the twisted de Rham cohomology $H^*(M, L)$ is the same as the ordinary de Rham cohomology.*

Integration of Densities, Poincaré Duality, and the Thom Isomorphism

Let M be a manifold of dimension n with coordinate open cover $\{(U_\alpha, \phi_\alpha)\}$ and transition functions $g_{\alpha\beta}$. A *density* on M is an element of $\Omega^*(M, L)$, or equivalently, a section of the *density bundle* $(\Lambda^n T_M^*) \otimes L$. One may think of a density as a top-dimensional differential form twisted by the orientation bundle. Since the transition function for the exterior power $\Lambda^n T_M^*$ is $1/J(g_{\alpha\beta})$, the transition function for the density bundle is

$$\frac{1}{J(g_{\alpha\beta})} \cdot \text{sgn } J(g_{\alpha\beta}) = \frac{1}{|J(g_{\alpha\beta})|}.$$

Let e_α be the section of $L|_{U_\alpha}$ corresponding to 1 under the trivialization of L induced from the atlas $\{(U_\alpha, \phi_\alpha)\}$. If $\phi_\alpha = (x_1, \dots, x_n)$ are the coordinates on U_α , we define the density $|dx_1 \cdots dx_n|$ in $\Gamma(U_\alpha, (\Lambda^n T_M^* \otimes L))$ to be

$$|dx_1 \cdots dx_n| = e_\alpha dx_1 \cdots dx_n.$$

Locally we may then write a density as $g(x_1, \dots, x_n)|dx_1 \cdots dx_n|$ for some smooth function g .

Let $T: \mathbb{R}^n \rightarrow \mathbb{R}^n$ be a diffeomorphism of \mathbb{R}^n with coordinates x_1, \dots, x_n and y_1, \dots, y_n respectively. If $\omega = g|dy_1 \cdots dy_n|$ is a density on \mathbb{R}^n , the pullback of ω by T is

$$\begin{aligned} T^*\omega &= (g \circ T)|d(y_1 \circ T) \cdots d(y_n \circ T)| \\ &= (g \circ T)|J(T)||dx_1 \cdots dx_n|. \end{aligned}$$

The density $g|dy_1 \cdots dy_n|$ is said to have compact support on \mathbb{R}^n if g has compact support, and the integral of such a density over \mathbb{R}^n is defined to be the corresponding Riemann integral. Then

$$\begin{aligned} \int_{\mathbb{R}^n} T^*\omega &= \int_{\mathbb{R}^n} (g \circ T)|J(T)||dx_1 \cdots dx_n| \\ &= \int_{\mathbb{R}^n} g|dy_1 \cdots dy_n| \quad \text{by the change of variable formula} \\ &= \int_{\mathbb{R}^n} \omega. \end{aligned}$$

Thus the integration of a density is invariant under the group of all diffeomorphisms on \mathbb{R}^n . This means we can globalize the integration of a density to a manifold. If $\{\rho_\alpha\}$ is a partition of unity subordinate to the open cover $\{(U_\alpha, \phi_\alpha)\}$ and $\omega \in \Omega_c^n(M, L)$, define

$$\int_M \omega = \sum_\alpha \int_{\mathbb{R}^n} (\phi_\alpha^{-1})^* (\rho_\alpha \omega).$$

It is easy to check that this definition is independent of the choices involved.

Just as for differential forms there is a Stokes' theorem for densities. We state below only the weak version that we need.

Theorem 7.7 (Stokes' Theorem for Densities). *On any manifold M of dimension n , orientable or not, if $\omega \in \Omega_c^{n-1}(M, L)$, then*

$$\int_M d\omega = 0.$$

The proof is essentially the same as (3.5).

It follows from this Stokes' theorem that the pairings

$$\Omega^q(M) \otimes \Omega_c^{n-q}(M, L) \rightarrow \mathbb{R}$$

and

$$\Omega_c^q(M) \otimes \Omega^{n-q}(M, L) \rightarrow \mathbb{R}$$

given by

$$\omega \wedge \tau \mapsto \int_M \omega \wedge \tau$$

descend to cohomology.

Theorem 7.8 (Poincaré Duality). *On a manifold M of dimension n with a finite good cover, there are nondegenerate pairings*

$$H^q(M) \otimes_{\mathbb{R}} H_c^{n-q}(M, L) \rightarrow \mathbb{R}$$

and

$$H_c^q(M) \otimes_{\mathbb{R}} H^{n-q}(M, L) \rightarrow \mathbb{R}.$$

PROOF. By tensoring the Mayer-Vietoris sequences (2.2) and (2.7) with $\Gamma(M, L)$ we obtain the corresponding Mayer-Vietoris sequences for twisted cohomology. The Mayer-Vietoris argument for Poincaré duality on an orientable manifold then carries over word for word. \square

Corollary 7.8.1. *Let M be a connected manifold of dimension n having a finite good cover. Then*

$$H^n(M) = \begin{cases} \mathbb{R} & \text{if } M \text{ is compact orientable} \\ 0 & \text{otherwise.} \end{cases}$$

PROOF. By Poincaré duality, $H^n(M) = H_c^0(M, L)$. Let $\{U_\alpha\}$ be a coordinate open cover for M . An element of $H_c^0(M, L)$ is given by a collection of constants f_α on U_α satisfying

$$f_\alpha = (\text{sgn } J(g_{\alpha\beta})) f_\beta.$$

If $f_\alpha = 0$ for some α , then by the connectedness of M , we have $f_\alpha = 0$ for all α . It follows that a nonzero element of $H_c^0(M, L)$ is nowhere vanishing. Thus, $H_c^0(M, L) \neq 0$ if and only if M is compact and L has a nowhere-vanishing section, i.e., M is compact orientable. In that case,

$$H_c^0(M, L) = H_c^0(M) = \mathbb{R}. \quad \square$$

Exercise 7.9. Let M be a manifold of dimension n . Compute the cohomology groups $H_c^q(M)$, $H^q(M, L)$, and $H_c^q(M, L)$ for each of the following four cases: M compact orientable, noncompact orientable, compact nonorientable, noncompact nonorientable.

Finally, we state but do not prove the Thom isomorphism theorem in all orientational generality. Let E be a rank n vector bundle over a manifold

M , and let $\{(U_\alpha, \phi_\alpha)\}$ and $g_{\alpha\beta}$ be a trivialization and transition functions for E . Neither E nor M is assumed to be orientable. The *orientation bundle* of E , denoted $\alpha(E)$, is the line bundle over M with transition functions $\text{sgn } J(g_{\alpha\beta})$. With this terminology, the orientation bundle of M is simply the orientation bundle of its tangent bundle T_M . It is easy to see that when E is not orientable, integration along the fiber of a form in $\Omega_{cv}^*(E)$ does not yield a global form on M , but an element of the twisted complex $\Omega^*(M, \alpha(E))$.

Theorem 7.10 (Nonorientable Thom Isomorphism). *Under the hypothesis above, integration along the fiber gives an isomorphism*

$$\pi_* : H_{cv}^{*+n}(E) \simeq H^*(M, \alpha(E)).$$

Exercise 7.11. Compute the twisted de Rham cohomology $H^*(\mathbb{R}P^n, L)$.

CHAPTER II

The Čech-de Rham Complex

§8 The Generalized Mayer-Vietoris Principle

Reformulation of the Mayer-Vietoris Sequence

Let U and V be open sets on a manifold. In Section 2, we saw that the sequence of inclusions

$$U \cup V \leftarrow U \amalg V \rightarrow U \cap V$$

gives rise to an exact sequence of differential complexes

$$0 \rightarrow \Omega^*(U \cup V) \rightarrow \Omega^*(U) \oplus \Omega^*(V) \rightarrow \Omega^*(U \cap V) \rightarrow 0$$

called the *Mayer-Vietoris sequence*. The associated long exact sequence

$$\cdots \rightarrow H^q(U \cup V) \xrightarrow{\alpha} H^q(U) \oplus H^q(V) \xrightarrow{\beta} H^q(U \cap V) \xrightarrow{\gamma} H^{q+1}(U \cup V) \rightarrow \cdots$$

allows one to compute in many cases the cohomology of the union $U \cup V$ from the cohomology of the open subsets U and V . In this section, the Mayer-Vietoris sequence will be generalized from two open sets to countably many open sets. The main ideas here are due to Weil [1].

To make this generalization more transparent, we first reformulate the Mayer-Vietoris sequence for two open sets as follows. Let \mathcal{U} be the open cover $\{U, V\}$. Consider the double complex $C^*(\mathcal{U}, \Omega^*) = \bigoplus K^{p,q} = \bigoplus C^p(\mathcal{U}, \Omega^q)$ where

$$K^{0,q} = C^0(\mathcal{U}, \Omega^q) = \Omega^q(U) \oplus \Omega^q(V),$$

$$K^{1,q} = C^1(\mathcal{U}, \Omega^q) = \Omega^q(U \cap V),$$

$$K^{p,q} = 0, \quad p \geq 2.$$

	$q \uparrow$			
	3	\vdots	\vdots	\vdots
	2	$\Omega^2(U) \oplus \Omega^2(V)$	$\Omega^2(U \cap V)$	0
	1	$\Omega^1(U) \oplus \Omega^1(V)$	$\Omega^1(U \cap V)$	0
	0	$\Omega^0(U) \oplus \Omega^0(V)$	$\Omega^0(U \cap V)$	0
		0	1	2
				$p \rightarrow$

This double complex is equipped with two differential operators, the exterior derivative d in the vertical direction and the difference operator δ in the horizontal direction. Of course, δ is 0 after the first column. Because d and δ are independent operators, they commute.

In general given a doubly graded complex $K^{p,q}$ with commuting differentials d and δ , one can form a singly graded complex K^n by summing along the antidiagonal lines

$$K^n = \bigoplus_{p+q=n} K^{p,q}$$

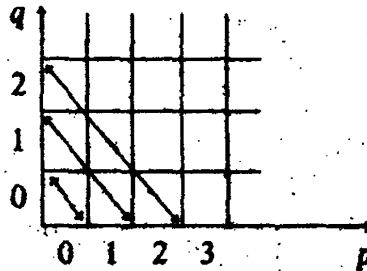

and defining the differential operator to be

$$D = D' + D'' \text{ with } D' = \delta, D'' = (-1)^p d \text{ on } K^{p,q}.$$

REMARK ON THE DEFINITION OF D.

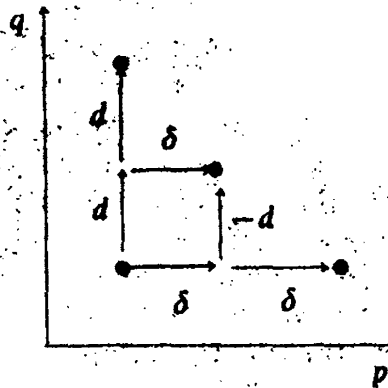

If D were naively defined as $\tilde{D} = d + \delta$, it would not be a differential operator since $\tilde{D}^2 = 2d\delta \neq 0$. However, if we alternate the sign of d from one column to the next, then as is apparent from the diagram above,

$$D^2 = d^2 + \delta d - d\delta + \delta^2 = 0.$$

In the sequel we will use the same symbol $C^*(U, \Omega^*)$ to denote the double complex and its associated single complex. In this setup, the Mayer-Vietoris principle assumes the following form.

Theorem 8.1. *The double complex $C^*(U, \Omega^*)$ computes the de Rham cohomology of M :*

$$H_D\{C^*(U, \Omega^*)\} \cong H_{dR}^*(M).$$

PROOF. In one direction there is the natural map

$$r: \Omega^*(M) \rightarrow \Omega^*(U) \oplus \Omega^*(V) \subset C^*(U, \Omega^*)$$

given by the restriction of forms. Our first observation is that r is a chain map, i.e., that the following diagram is commutative:

$$\begin{array}{ccc} \Omega^*(M) & \xrightarrow{r} & C^*(U, \Omega^*) \\ d \uparrow & & \uparrow D \\ \Omega^*(M) & \xrightarrow{r} & C^*(U, \Omega^*) \end{array}$$

This is because

$$\begin{aligned} Dr &= (\delta + (-1)^p dr) \quad [\text{here } p = 0] \\ &= dr \\ &= rd. \end{aligned}$$

Consequently r induces a map in cohomology

$$r^* : H_{dR}^*(M) \rightarrow H_D\{(C^*(U, \Omega^*)\}$$

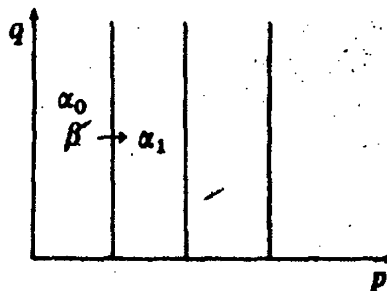

A q -cochain α in the double complex $C^*(U, \Omega^*)$ has two components

$$\alpha = \alpha_0 + \alpha_1, \quad \alpha_0 \in K^{0,q}, \quad \alpha_1 \in K^{1,q-1}.$$

By the exactness of the Mayer-Vietoris sequence there exists a β such that $\delta\beta = \alpha_1$. With this choice of β , $\alpha - D\beta$ has only the $(0, q)$ -component. Thus, every cochain in $C^*(U, \Omega^*)$ is D -cohomologous to a cochain with only the top component.

We now show r^* to be an isomorphism.

Step 1. r^ is surjective.*

By the remark above we may assume that a given cohomology class in $H_D\{C^*(U, \Omega^*)\}$ is represented by a cocycle ϕ with only the top component. In this case

$$D\phi = 0 \quad \text{if and only if} \quad d\phi = \delta\phi = 0.$$

So ϕ is a global closed form.

Step 2. r^ is injective.*

Suppose $r(\omega) = D\phi$ for some cochain ϕ in $C^*(U, \Omega^*)$. Again by the remark above we may write $\phi = \phi' + D\phi''$, where ϕ' has only the top component. Then

$$r(\omega) = D\phi' = d\phi', \quad \delta\phi' = 0.$$

So ω is the exterior derivative of a global form on M .

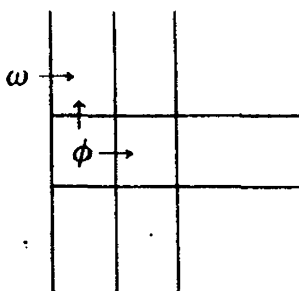

□

Generalization to Countably Many Open Sets and Applications

Instead of a cover with two open sets as in the usual Mayer-Vietoris sequence, consider the open cover $U = \{U_\alpha\}_{\alpha \in J}$ of M , where the index set J is a countable *ordered* set. Of course J may be finite. Denote the pairwise intersections $U_\alpha \cap U_\beta$ by $U_{\alpha\beta}$, triple intersections $U_\alpha \cap U_\beta \cap U_\gamma$ by $U_{\alpha\beta\gamma}$, etc. There is a sequence of inclusions of open sets

$$M \leftarrow \coprod U_{\alpha_0} \xleftarrow[\leftarrow]{\delta_0} \coprod_{\alpha_0 < \alpha_1} U_{\alpha_0 \alpha_1} \xleftarrow[\leftarrow]{\delta_1} \coprod_{\alpha_0 < \alpha_1 < \alpha_2} U_{\alpha_0 \alpha_1 \alpha_2} \xleftarrow[\leftarrow]{\delta_2} \dots$$

where δ_i is the inclusion which "ignores" the i th open set; for example,

$$\delta_0 : U_{\alpha_0 \alpha_1 \alpha_2} \rightarrow U_{\alpha_1 \alpha_2}.$$

This sequence of inclusions of open sets induces a sequence of restrictions of forms

$$\Omega^*(M) \xrightarrow{\quad} \prod \Omega^*(U_{\alpha_0}) \rightrightarrows \prod_{\alpha_0 < \alpha_1} \Omega^*(U_{\alpha_0 \alpha_1}) \xrightarrow[\rightarrow]{\delta_1} \prod_{\alpha_0 < \alpha_1 < \alpha_2} \Omega^*(U_{\alpha_0 \alpha_1 \alpha_2}) \xrightarrow[\rightarrow]{\delta_2} \dots$$

where δ_0 , for instance, is induced from the inclusion

$$\partial_0 : \coprod_{\alpha} U_{\alpha\beta\gamma} \rightarrow U_{\beta\gamma}$$

and therefore is the restriction

$$\delta_0 : \Omega^*(U_{\beta\gamma}) \rightarrow \coprod_{\alpha} \Omega^*(U_{\alpha\beta\gamma}).$$

We define the difference operator $\delta : \prod \Omega^*(U_{\alpha_0 \alpha_1}) \rightarrow \prod \Omega^*(U_{\alpha_0 \alpha_1 \alpha_2})$ to be the alternating difference $\delta_0 - \delta_1 + \delta_2$. Thus

$$(\delta\xi)_{\alpha_0 \alpha_1 \alpha_2} = \xi_{\alpha_1 \alpha_2} - \xi_{\alpha_0 \alpha_2} + \xi_{\alpha_0 \alpha_1}.$$

More generally the difference operator is defined as follows.

Definition 8.2. If $\omega \in \prod \Omega^q(U_{\alpha_0 \dots \alpha_p})$, then ω has "components" $\omega_{\alpha_0 \dots \alpha_p} \in \Omega^q(U_{\alpha_0 \dots \alpha_p})$ and

$$(\delta\omega)_{\alpha_0 \dots \alpha_{p+1}} = \sum_{i=0}^{p+1} (-1)^i \omega_{\alpha_0 \dots \hat{\alpha}_i \dots \alpha_{p+1}},$$

where on the right-hand side the restriction operation to $U_{\alpha_0 \dots \alpha_{p+1}}$ has been suppressed and the caret denotes omission.

Proposition 8.3. $\delta^2 = 0$.

PROOF. Basically this is true because in $(\delta^2\omega)_{\alpha_0 \dots \alpha_{p+2}}$ we omit two indices α_i, α_j twice with opposite signs. To be precise,

$$\begin{aligned} (\delta^2\omega)_{\alpha_0 \dots \alpha_{p+2}} &= \sum (-1)^i (\delta\omega)_{\alpha_0 \dots \hat{\alpha}_i \dots \alpha_{p+2}} \\ &= \sum_{j < i} (-1)^i (-1)^j \omega_{\alpha_0 \dots \hat{\alpha}_j \dots \hat{\alpha}_i \dots \alpha_{p+2}} \\ &\quad + \sum_{j > i} (-1)^i (-1)^{j-1} \omega_{\alpha_0 \dots \hat{\alpha}_i \dots \hat{\alpha}_j \dots \alpha_{p+2}} \\ &= 0. \end{aligned}$$

Convention. Up until now the indices in $\omega_{\alpha_0 \dots \alpha_p}$ are all in increasing order $\alpha_0 < \dots < \alpha_p$. More generally we will allow indices in any order, even with repetitions, subject to the convention that when two indices are interchanged, the form becomes its negative:

$$\omega_{\dots \alpha \dots \beta \dots} = -\omega_{\dots \beta \dots \alpha \dots}$$

In particular a form with repeated indices is 0. In the following exercise the reader is asked to check that this convention is consistent with the definition of the difference operator δ above.

Exercise 8.4. Suppose $\alpha < \beta$. Then $(\delta\omega)_{\dots \beta \dots \alpha \dots}$ may be defined either as $-(\delta\omega)_{\dots \alpha \dots \beta \dots}$ or by the difference operator formula (8.2). Show that these two definitions agree.

Proposition 8.5. (The Generalized Mayer-Vietoris Sequence). *The sequence*

$$0 \rightarrow \Omega^*(M) \xrightarrow{r} \prod \Omega^*(U_{\alpha_0}) \xrightarrow{\delta} \prod \Omega^*(U_{\alpha_0\alpha_1}) \xrightarrow{\delta} \prod \Omega^*(U_{\alpha_0\alpha_1\alpha_2}) \xrightarrow{\delta} \dots$$

is exact; in other words, the δ -cohomology of this complex vanishes identically.

PROOF. Clearly $\Omega^*(M)$ is the kernel of the first δ since an element of $\prod \Omega^*(U_{\alpha_0})$ is a global form on M if and only if its components agree on the overlaps.

Now let $\{\rho_\alpha\}$ be a partition of unity subordinate to the open cover $\mathcal{U} = \{U_\alpha\}$. Suppose $\omega \in \prod \Omega^*(U_{\alpha_0 \dots \alpha_p})$ is a p -cocycle. Define a $(p-1)$ -cochain τ by

$$\tau_{\alpha_0 \dots \alpha_{p-1}} = \sum_{\alpha} \rho_{\alpha} \omega_{\alpha \alpha_0 \dots \alpha_{p-1}}.$$

Then

$$\begin{aligned} (\delta\tau)_{\alpha_0 \dots \alpha_p} &= \sum_i (-1)^i \tau_{\alpha_0 \dots \hat{\alpha}_i \dots \alpha_p} \\ &= \sum_{i, \alpha} (-1)^i \rho_{\alpha} \omega_{\alpha \alpha_0 \dots \hat{\alpha}_i \dots \alpha_p}. \end{aligned}$$

Because ω is a cocycle,

$$(\delta\omega)_{\alpha_0 \dots \alpha_p} = \omega_{\alpha_0 \dots \alpha_p} + \sum_i (-1)^{i+1} \omega_{\alpha_0 \dots \hat{\alpha}_i \dots \alpha_p} = 0.$$

So

$$\begin{aligned} (\delta\tau)_{\alpha_0 \dots \alpha_p} &= \sum_{\alpha} \rho_{\alpha} \sum_i (-1)^i \omega_{\alpha \alpha_0 \dots \hat{\alpha}_i \dots \alpha_p} \\ &= \sum_{\alpha} \rho_{\alpha} \omega_{\alpha \alpha_0 \dots \alpha_p} \\ &= \omega_{\alpha_0 \dots \alpha_p}. \end{aligned}$$

This shows that every cocycle is a coboundary. The exactness now follows from Proposition 8.3. \square

In fact, the definition of τ in this proof gives a homotopy operator on the complex. Write $K\omega$ for τ :

$$(8.6) \quad (K\omega)_{\alpha_0 \dots \alpha_{p-1}} = \sum_{\alpha} \rho_{\alpha} \omega_{\alpha \alpha_0 \dots \alpha_{p-1}}.$$

Then

$$\begin{aligned} (\delta K\omega)_{\alpha_0 \dots \alpha_p} &= \sum (-1)^i (K\omega)_{\alpha_0 \dots \hat{\alpha}_i \dots \alpha_p} \\ &= \sum (-1)^i \rho_{\alpha} \omega_{\alpha \alpha_0 \dots \hat{\alpha}_i \dots \alpha_p} \\ (K\delta\omega)_{\alpha_0 \dots \alpha_p} &= \sum \rho_{\alpha} (\delta\omega)_{\alpha \alpha_0 \dots \alpha_p} \\ &= \left(\sum \rho_{\alpha} \right) \omega_{\alpha_0 \dots \alpha_p} + \sum (-1)^{i+1} \rho_{\alpha} \omega_{\alpha \alpha_0 \dots \hat{\alpha}_i \dots \alpha_p} \\ &= \omega_{\alpha_0 \dots \alpha_p} - (\delta K\omega)_{\alpha_0 \dots \alpha_p}. \end{aligned}$$

Therefore, K is an operator from $\prod \Omega^*(U_{a_0 \dots a_p})$ to $\prod \Omega^*(U_{a_0 \dots a_{p-1}})$ such that

$$(8.7) \quad \delta K + K\delta = 1.$$

As in the proof of the Poincaré lemma, the existence of a homotopy operator on a differential complex implies that the cohomology of the complex vanishes.

For future reference we note here that if ϕ is a cocycle, then by (8.7), $\delta K\phi = \phi$. So on cocycles K is a right inverse to δ . Given ϕ , the set of all solutions ξ of $\delta\xi = \phi$ consists of $K\phi + \delta$ -coboundaries.

The Mayer-Vietoris sequence may be arranged as an augmented double complex

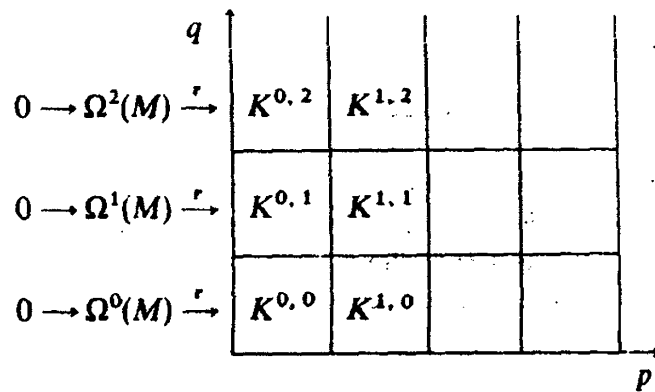

where $K^{p,q} = C^p(\mathcal{U}, \Omega^q) = \prod \Omega^q(U_{a_0 \dots a_p})$ consists of the " p -cochains of the cover \mathcal{U} with values in the q -forms." The horizontal maps of the double complex are the difference operators δ and the vertical ones the exterior derivatives d . As before, the double complex may be made into a single complex with the differential operator given by

$$D = D' + D'' = \delta + (-1)^p d.$$

A D -cocycle is a string such as $\phi = a + b + c$ with

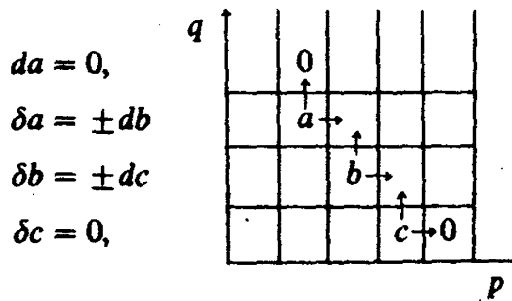

(To be precise we should write $\delta a = -D''b$, $\delta b = -D''c$.) So a D -cocycle may be pictured as a "zig-zag."

A D -coboundary is a string such as $\phi = a + b + c$ in the figure below, where $a = \delta a_1 + D'' a_2$, etc.

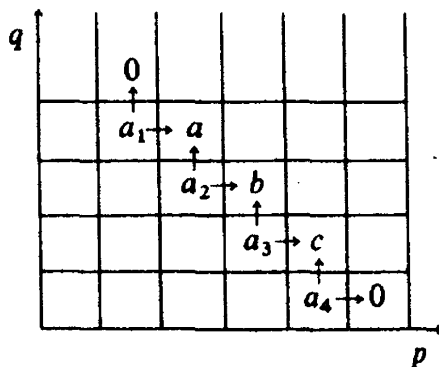

The double complex

$$C^*(U, \Omega^*) = \bigoplus_{p, q \geq 0} C^p(U, \Omega^q)$$

is called the Čech-de Rham complex, and an element of the Čech-de Rham is called a Čech-de Rham cochain. We sometimes refer to a Čech-de Rham cochain more simply as a D -cochain.

The fact that all the rows of the augmented complex are exact is the key ingredient in the proof of the following.

Proposition 8.8 (Generalized Mayer-Vietoris Principle). *The double complex $C^*(U, \Omega^*)$ computes the de Rham cohomology of M ; more precisely, the restriction map $r : \Omega^*(M) \rightarrow C^*(U, \Omega^*)$ induces an isomorphism in cohomology:*

$$r^* : H_{DR}^*(M) \rightarrow H_D\{C^*(U, \Omega^*)\}.$$

PROOF. Since $Dr = (\delta + d)r = dr = rd$, r is a chain map, and so it induces a map r^* in cohomology.

Step 1. r^ is surjective.*

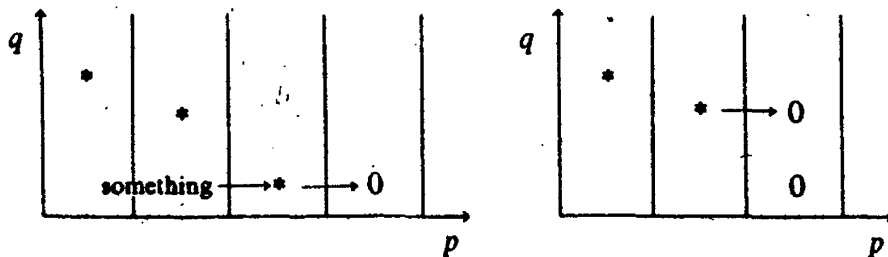

Let ϕ be a cocycle relative to D . By δ -exactness the lowest component of ϕ is δ of something. By subtracting $D(\text{something})$ from ϕ , we can remove the lowest component of ϕ and still stay in the same cohomology class as ϕ .

After iterating this procedure enough times we can move ϕ in its cohomology class to a cocycle ϕ' with only the top component. ϕ' is a closed global form because $d\phi' = 0$ and $\delta\phi' = 0$.

Step 2. r^* is injective.

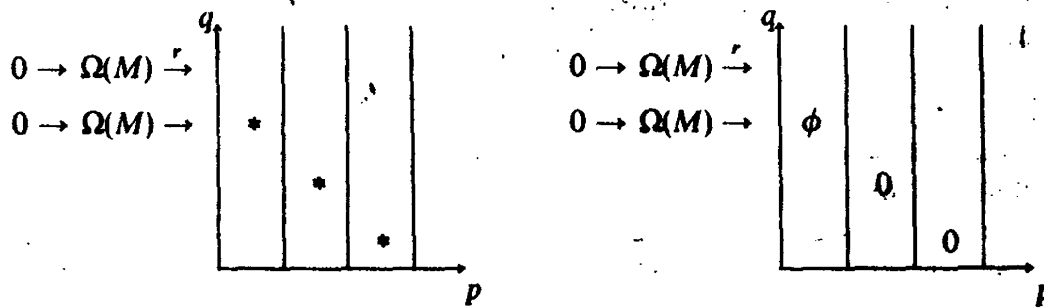

If $r(\omega) = D\phi$, we can shorten ϕ as before by subtracting boundaries until it consists of only the top component. Then because $\delta\phi$ is 0, it is actually a global form on M . So ω is exact. \square

The proof of this proposition is a very general argument from which we may conclude: *if all the rows of an augmented double complex are exact, then the D-cohomology of the complex is isomorphic to the cohomology of the initial column.*

It is natural to augment each column by the kernel of the bottom d , denoted $C^*(\mathcal{U}, \mathbb{R})$. The vector space $C^p(\mathcal{U}, \mathbb{R})$ consists of the locally constant functions on the $(p + 1)$ -fold intersections $U_{a_0 \dots a_p}$.

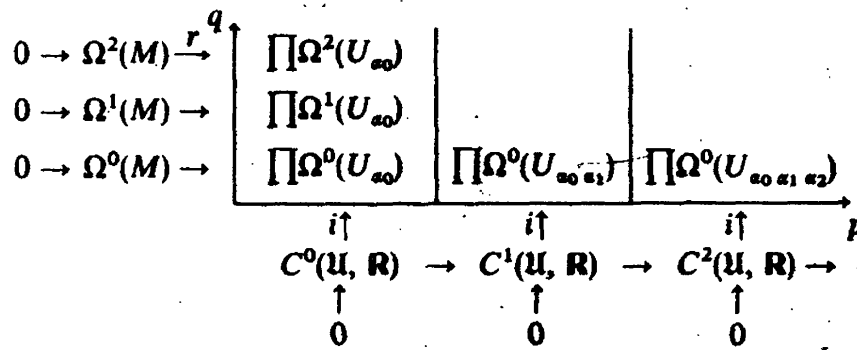

The bottom row

$$C^0(\mathcal{U}, \mathbb{R}) \xrightarrow{d} C^1(\mathcal{U}, \mathbb{R}) \xrightarrow{d} C^2(\mathcal{U}, \mathbb{R}) \xrightarrow{d} \dots$$

is a differential complex, and the homology of this complex, $H^*(\mathcal{U}, \mathbb{R})$, is called the Čech cohomology of the cover \mathcal{U} . This is a purely combinatorial object. Note that the argument for the exactness of the generalized Mayer-Vietoris sequence breaks down for the complex $C^*(\mathcal{U}, \mathbb{R})$, because here the cochains are locally constant functions so that partitions of unity are not applicable.

If the augmented columns of the complex $C^*(\mathcal{U}, \Omega^*)$ are exact, then the

same argument as in (8.8) will yield an isomorphism between the Čech cohomology and the cohomology of the double complex

$$H^*(\mathcal{U}, \mathbb{R}) \xrightarrow{\sim} H\{C^*(\mathcal{U}, \Omega^*)\},$$

and consequently an isomorphism between de Rham cohomology and Čech cohomology

$$H_{DR}^*(M) \simeq H^*(\mathcal{U}, \mathbb{R}).$$

Now the failure of the p^{th} column to be exact is measured by the cohomology groups

$$\prod_{\substack{q \geq 1 \\ \alpha_0 < \dots < \alpha_p}} H^q(U_{\alpha_0 \dots \alpha_p}).$$

So if the cover is such that all finite nonempty intersections are contractible, e.g., a **good cover**, then all augmented columns will be exact. We have proven

Theorem 8.9. *If \mathcal{U} is a good cover of the manifold M , then the de Rham cohomology of M is isomorphic to the Čech cohomology of the good cover*

$$H_{DR}(M) \simeq H(\mathcal{U}, \mathbb{R}).$$

Let us recapitulate here what has transpired so far. First, the basic sequence of inclusions

$$M \leftarrow U_\alpha \rightrightarrows U_{\alpha\beta} \rightleftarrows U_{\alpha\beta\gamma} \rightleftarrows \dots$$

gives rise to the diagram

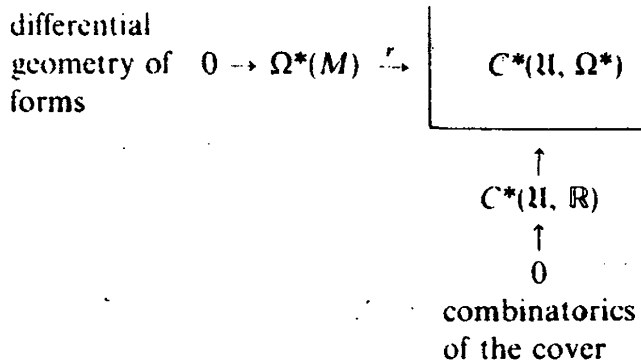

Along the left-hand side is the differential geometry of forms on M , along the bottom is the combinatorics of the cover $\mathcal{U} = \{U_\alpha\}$, and in the double complex itself the two are mixed. As the complex is the generalized Mayer-Vietoris sequence, the augmented rows are exact, for any cover. It follows that the de Rham cohomology of M is always isomorphic to the cohomol-

ogy of the double complex:

$$H_{DR}^*(M) \simeq H_D \{C^*(\mathcal{U}, \Omega^*)\}.$$

If in addition \mathcal{U} is a *good* cover, then by the Poincaré lemma the augmented columns are exact. In that case the Čech cohomology of the cover is also isomorphic to the cohomology of the double complex:

$$H^*(\mathcal{U}, \mathbb{R}) \simeq H_D \{C^*(\mathcal{U}, \Omega^*)\}.$$

Hence there is an isomorphism between de Rham and Čech. This result provides us with a way of computing the de Rham cohomology by means of combinatorics, since from Section 5 we know that every manifold has a good cover. All three complexes here can be given product structures, in which case the isomorphisms between them are actually isomorphisms of algebras, as will be shown in (14.28).

A priori there is no reason why different covers of M should have the same Čech cohomology. However, it follows from Theorem 8.9 that

Corollary 8.9.1. *The Čech cohomology $H^*(\mathcal{U}, \mathbb{R})$ is the same for all good covers \mathcal{U} of M .*

If a manifold is compact, then it has a *finite* good cover. For such a cover the Čech cohomology $H^*(\mathcal{U}, \mathbb{R})$ is clearly finite-dimensional. Thus,

Corollary 8.9.2. *The de Rham cohomology $H_{DR}^*(M)$ of a compact manifold is finite-dimensional.*

In fact,

Corollary 8.9.3. *Whenever M has a finite good cover, its de Rham cohomology $H_{DR}^*(M)$ is finite-dimensional.*

Both the proof here and the induction argument in Section 5 of the finite dimensionality of the de Rham cohomology rest on the Mayer-Vietoris sequence, but they are otherwise independent of each other.

§9 More Examples and Applications of the Mayer-Vietoris Principle

In the previous section we used the Mayer-Vietoris principle to show the isomorphism of the de Rham cohomology of a manifold and the Čech cohomology of a good cover; from this, various corollaries follow. In this section, after some examples in which the combinatorics of a good cover is used to compute the de Rham cohomology, we give an explicit isomor-

phism from Čech to de Rham: given a Čech cocycle, we construct the corresponding global closed differential form by means of a collating formula (9.5) based on the homotopy operator K of (8.6). To conclude the section, we give as another application of the Mayer-Vietoris principle a proof of the Künneth formula valid under the hypothesis that one of the factors has finite-dimensional cohomology.

Examples: Computing the de Rham Cohomology from the Combinatorics of a Good Cover

Let $\mathcal{U} = \{U_\alpha\}$ be an open cover of a manifold M . The nerve of \mathcal{U} is a simplicial complex constructed as follows. To every open set U_α , we associate a vertex α . If $U_\alpha \cap U_\beta$ is nonempty, we connect the vertices α and β with an edge. If $U_\alpha \cap U_\beta \cap U_\gamma$ is nonempty, we fill in the face of the triangle $\alpha\beta\gamma$. Repeating this procedure for all finite intersections gives the nerve of \mathcal{U} , denoted $N(\mathcal{U})$. For the basics of simplicial complexes, see Croom [1].

EXAMPLE 9.1 (The circle). Let $\mathcal{U} = \{U_0, U_1, U_2\}$ be the good cover of the circle as shown in Figure 9.1. The Čech complex has two terms:

$$C^0(\mathcal{U}, \mathbb{R}) = \mathbb{R} \oplus \mathbb{R} \oplus \mathbb{R} = \{(\omega_0, \omega_1, \omega_2) \mid \omega_\alpha \text{ is a constant on } U_\alpha\},$$

$$C^1(\mathcal{U}, \mathbb{R}) = \mathbb{R} \oplus \mathbb{R} \oplus \mathbb{R} = \{(\eta_{01}, \eta_{02}, \eta_{12}) \mid \eta_{\alpha\beta} \text{ is a constant on } U_{\alpha\beta}\}.$$

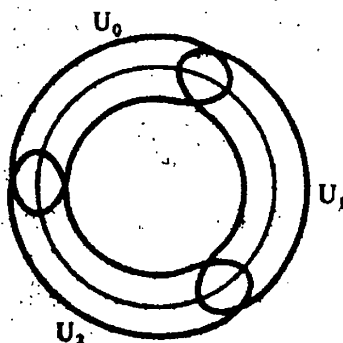

Figure 9.1

The coboundary $\delta : C^0 \rightarrow C^1$ is given by $(\delta\omega)_{\alpha\beta} = \omega_\beta - \omega_\alpha$. Therefore,

$$\ker \delta = \{(\omega_0, \omega_1, \omega_2) \mid \omega_0 = \omega_1 = \omega_2\} = \mathbb{R}$$

and

$$H^0(S^1) = \mathbb{R}.$$

Since $\text{im } \delta = \mathbb{R}^2$, $H^1(S^1) = \mathbb{R}^3 / \text{im } \delta = \mathbb{R}$.

EXAMPLE 9.2 (A nontrivial 1-cocycle on the circle). If a 1-cocycle $\eta = (\eta_{01}, \eta_{02}, \eta_{12})$ is a coboundary, then $\eta_{01} - \eta_{02} + \eta_{12} = 0$. So $\eta = (1, 0, 0)$ is a nontrivial 1-cocycle on the circle.

EXAMPLE 9.3 (The 2-sphere). Cover the lower hemisphere of Figure 9.2 with three open sets as in Figure 9.3. Together with the upper hemisphere U_0 , this gives a good cover of the entire sphere. The nerve of the cover is the surface of a tetrahedron as depicted in Figure 9.4. The Čech complex has

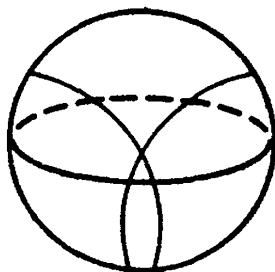

Figure 9.2

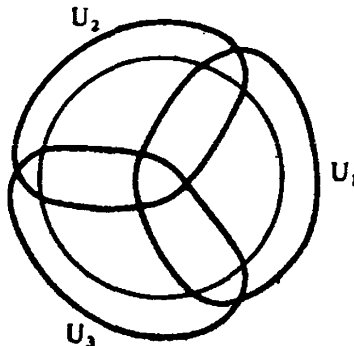

Figure 9.3

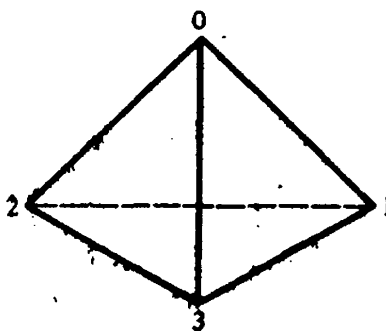

Figure 9.4

three terms:

$$\begin{array}{ccccccc}
 C^0(\mathcal{U}, \mathbb{R}) & \xrightarrow{\delta_0} & C^1(\mathcal{U}, \mathbb{R}) & \xrightarrow{\delta_1} & C^2(\mathcal{U}, \mathbb{R}) & & \\
 \mathbb{R} \oplus \mathbb{R} \oplus \mathbb{R} & \oplus & \mathbb{R} \oplus \mathbb{R} \oplus \mathbb{R} \oplus \mathbb{R} & \oplus & \mathbb{R} \oplus \mathbb{R} \oplus \mathbb{R} & \oplus & \mathbb{R} \\
 0 & 1 & 2 & 3 & 01 & 02 & 03 & 12 & 13 & 23 & 012 & 013 & 023 & 123
 \end{array}$$

$$\ker \delta_0 = \{(\omega_0, \omega_1, \omega_2, \omega_3) \mid \omega_0 = \omega_1 = \omega_2 = \omega_3\} = \mathbb{R}$$

So $\text{im } \delta_0 = \mathbb{R}^3$ and $H^0(S^2) = \mathbb{R}$. If η is in $\ker \delta_1$, then η is completely determined by η_{01}, η_{02} , and η_{03} . Therefore $\ker \delta_1 = \mathbb{R}^3$ and

$$H^1(S^2) = \ker \delta_1 / \text{im } \delta_0 = 0.$$

Since $\text{im } \delta_1 = C^1 / \ker \delta_1 = \mathbb{R}^3$,

$$H^2(S^2) = \mathbb{R}^4 / \text{im } \delta_1 = \mathbb{R}.$$

Explicit Isomorphisms between the Double Complex and de Rham and Čech

We saw in Proposition 8.8 that the Čech-de Rham complex $C^*(\mathcal{U}, \Omega^*)$ and the de Rham complex $\Omega^*(M)$ have the same cohomology. Actually, what is true is that these two complexes are chain homotopic. To be more precise, there is a chain map

$$(9.4) \quad f: C^*(\mathcal{U}, \Omega^*) \rightarrow \Omega^*(M)$$

such that

- (a) $f \circ r = 1$, and
- (b) $r \circ f$ is chain homotopic to the identity.

We may think of f as a recipe for collating together the components of a Čech-de Rham cochain into a global form. The not very intuitive formulas below were obtained, after repeated tries, by a careful bookkeeping of the inductive steps in the proof of Proposition 8.8.

Proposition 9.5 (The Collating Formula). *Let K be the homotopy operator defined in (8.6). If $\alpha = \sum_{i=0}^n \alpha_i$ is an n -cochain and $D\alpha = \beta = \sum_{i=0}^{n+1} \beta_i$, then*

$$f(\alpha) = \sum_{i=0}^n (-D''K)^i \alpha_i - \sum_{i=0}^{n+1} K(-D''K)^{i-1} \beta_i \in C^0(\mathcal{U}, \Omega^n)$$

is a global form satisfying the properties above. The homotopy operator

$$L: C^*(\mathcal{U}, \Omega^*) \rightarrow C^*(\mathcal{U}, \Omega^*)$$

such that $1 - r \circ f = DL + LD$ is given by

$$L\alpha = \sum_{p=0}^{n-1} (L\alpha)_p,$$

where

$$(Lx)_p = \sum_{i=p+1}^n K(-D''K)^{i-(p+1)} \alpha_i \in C^p(\mathcal{U}, \Omega^{n-1-p}).$$

β_0						
α_0	β_1					
	α_1	β_2				
		α_2	β_3			
					α_n	β_{n+1}

REMARK. To strip away some of the mysteries in the expression for $f(\alpha)$, it may be helpful to observe that the operator $D''K$ sends an element of $C^p(\mathcal{U}, \Omega^q)$ into $C^{p-1}(\mathcal{U}, \Omega^{q+1})$, so that $(D''K)^i \alpha_i$ and $K(D''K)^{i-1} \beta_i$ are collections of n -forms on the open sets U_α . The collating formula says that a suitable linear combination of these local n -forms, with ± 1 as coefficients, is the restriction of a global form.

The proof of Proposition 9.5 requires the following technical lemma.

Lemma 9.6.

$$\delta(D''K)^i = (D''K)^i \delta - (D''K)^{i-1} D''.$$

PROOF OF LEMMA 9.6. Since δ anticommutes with D'' and since $\delta K + K\delta = 1$,

$$\begin{aligned} \delta(D''K)(D''K)^{i-1} &= -D''\delta K(D''K)^{i-1} \\ &= -D''(1 - K\delta)(D''K)^{i-1} \\ &= (D''K)\delta(D''K)^{i-1}. \end{aligned}$$

So we can commute $D''K$ and δ until we reach $(D''K)^{i-1} \delta(D''K)$. Then,

$$\begin{aligned} \delta(D''K)^i &= (D''K)^{i-1} \delta(D''K) \\ &= -(D''K)^{i-1} D''(1 - K\delta) \\ &= -(D''K)^{i-1} D'' + (D''K)^i \delta. \quad \square \end{aligned}$$

PROOF OF PROPOSITION 9.5. To show that $f(\alpha)$ is a global form, we compute $\delta f(\alpha)$. Using the lemma above and the fact that $\delta \alpha_i + D'' \alpha_{i+1} = \beta_{i+1}$, this is a straightforward exercise which we leave to the reader.

Exercise 9.7. Show that $\delta f(\alpha) = 0$.

Next we check that f is a chain map.

$$f(D\alpha) = f(\beta) = \sum_{i=0}^{n+1} (-1)^i (D''K)^i \beta_i.$$

$$df(\alpha) = D''f(\alpha) = \beta_0 + \sum_{i=1}^{n+1} (-1)^i (D''K)^i \beta_i.$$

So

$$f(D\alpha) = df(\alpha).$$

The verification of Property (a) is easy, since if α is a global form, then $\alpha = \alpha_0$ and

$$f \circ r(\alpha) = f(\alpha) = \alpha_0 = \alpha.$$

Property (b) follows from the fact that

$$1 - r \circ f = DL + LD.$$

As its verification is straightforward and not very illuminating, we shall omit it. The skeptical reader may wish to carry it out for himself. Apart from the definitions, the only facts needed are Lemma 9.6 and the chain-homotopy formula (8.7). \square

REMARK. Actually the existence of the chain-homotopy inverse f and the homotopy operator L is guaranteed by a general principle in the theory of chain complexes (See Spanier [1, Ch. 4, Sec. 2; in particular, Cor. 11, p. 167]).

We can now give an explicit description of the various isomorphisms that follow from the generalized Mayer-Vietoris principle. For example, by applying the collating formula (9.5), we get

Proposition 9.8 (Explicit Isomorphism between de Rham and Čech). *If $\eta \in C^n(\mathcal{U}, \mathbb{R})$ is a Čech cocycle, then the global closed form corresponding to it is given by $f(\eta) = (-1)^n (D''K)^n \eta$.*

EXAMPLE 9.9. Let \mathcal{U} be a good cover of the circle S^1 . We shall construct from a generator of the Čech cohomology $H^1(\mathcal{U}, \mathbb{R})$ a differential form representing a generator of the de Rham cohomology $H_{DR}^1(S^1)$.

As we saw in Example 9.2, a nontrivial 1-cocycle on S^1 is

$$\eta = (\eta_{01}, \eta_{02}, \eta_{12}) = (1, 0, 0).$$

If $\{\rho_\alpha\}$ is a partition of unity, then

$$K\eta = (-\rho_1, \rho_0, 0).$$

So the generator $-D''K\eta$ of $H_{DR}^1(S^1)$ is represented by $-d(-\rho_1)$, a bump form on $U_0 \cap U_1$ with total integral 1.

Exercise 9.10. The real projective plane $\mathbb{R}P^2$ is obtained by identifying the boundary of a disc as shown in Figure 9.5. Find a good cover for $\mathbb{R}P^2$ and

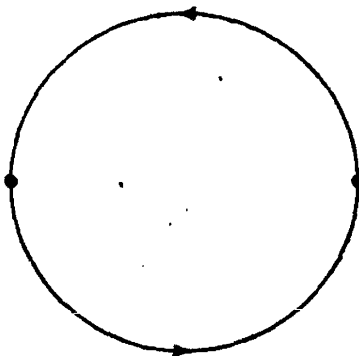

Figure 9.5

compute its de Rham cohomology from the combinatorics of the cover. One possible good cover has the nerve depicted in Figure 9.6.

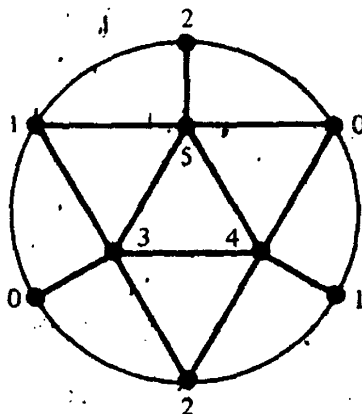

Figure 9.6

Exercise 9.11. Let Figure 9.7 be the nerve of a good cover \mathcal{U} on the torus, where the arrows indicate how the vertices are ordered. Write down a nontrivial 1-cocycle in $C^1(\mathcal{U}, \mathbb{R})$.

The Tic-Tac-Toe Proof of the Künneth Formula

We now apply the main theorems of the preceding section to give another proof of the Künneth formula. This proof, admittedly more involved in its

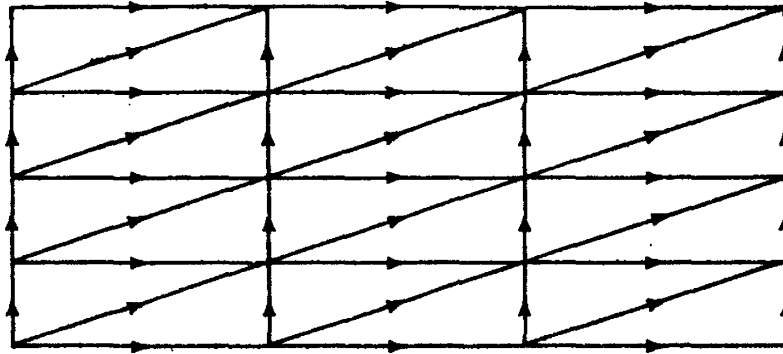

Figure 9.7

construction than the Mayer-Vietoris argument of Section 5, is a prototype for the spectral sequence argument of Chapter III. It will also allow us to replace the requirement that M has a finite good cover by the slightly weaker hypothesis that F has finite-dimensional cohomology.

Before commencing the proof we make some general remarks about a technique for studying maps. Let $\pi : E \rightarrow M$ be a map of manifolds. A cover \mathcal{U} on M induces a cover $\pi^{-1}\mathcal{U}$ on E , and we have the inclusions

$$\begin{array}{c} E \leftarrow \coprod \pi^{-1}U_\alpha \quad \rightleftarrows \coprod \pi^{-1}U_{\alpha\beta} \quad \rightleftarrows \cdots \\ \pi \downarrow \\ M \leftarrow \coprod U_\alpha \quad \rightleftarrows \coprod U_{\alpha\beta} \quad \rightleftarrows \cdots \end{array}$$

In general $U_\alpha \cap U_\beta \neq \emptyset$ is not equivalent to $\pi^{-1}U_\alpha \cap \pi^{-1}U_\beta \neq \emptyset$. However, if π is surjective, then the two statements are equivalent, so that in this case the combinatorics of the covers \mathcal{U} and $\pi^{-1}\mathcal{U}$ are the same. The double complex of the inverse cover computes the cohomology of E , which can then be related to the cohomology of M , because the inverse cover comes from a cover on M . This idea will be systematically exploited throughout this chapter and the next.

A quick example of how the inverse cover $\pi^{-1}\mathcal{U}$ may be used to study maps is the following. Note that although the inverse image of a good cover is usually not a good cover, for a vector bundle $\pi : E \rightarrow M$ the "goodness" of the cover is preserved. Since the de Rham cohomology is determined by the combinatorics of a good cover, this implies that

$$H_{DR}^*(E) \simeq H_{DR}^*(M).$$

Of course, this also follows from the homotopy axiom for the de Rham cohomology (Corollary 4.1.2.2).

Proposition 9.12 (Künneth Formula). *If M and F are two manifolds and F has finite-dimensional cohomology, then the de Rham cohomology of the product $M \times F$ is*

$$H^*(M \times F) = H^*(M) \otimes H^*(F).$$

PROOF. Let $\mathcal{U} = \{U_\alpha\}$ be a good cover for M and $\pi : M \times F \rightarrow M$ the projection onto the first factor. Then $\pi^{-1}\mathcal{U} = \{\pi^{-1}U_\alpha\}$ is some sort of a cover for $E = M \times F$, though in general not a good cover. There is a natural map

$$\begin{array}{c} C^*(\pi^{-1}\mathcal{U}, \Omega^*) \\ \uparrow \pi^* \\ C^*(\mathcal{U}, \Omega^*) \end{array}$$

which pulls back differential forms on open sets. Choose a basis for $H^*(F)$, say $\{[\omega_\alpha]\}$, and choose differential forms ω_α representing them. These may be used to define a map of double complexes

$$\begin{array}{c} C^*(\pi^{-1}\mathcal{U}, \Omega^*) \\ \uparrow \pi_{\mathcal{U}}^* \\ H^*(F) \otimes C^*(\mathcal{U}, \Omega^*) \end{array}$$

by

$$\pi_{\mathcal{U}}^*([\omega_\alpha] \otimes \phi) = \rho^*\omega_\alpha \wedge \pi^*\phi$$

where ρ is the projection on the fiber

$$\begin{array}{ccc} E & \xrightarrow{\rho} & F \\ \downarrow \pi & & \\ M & & \end{array}$$

Since $H^*(F)$ is a vector space, $H^*(F) \otimes C^*(\mathcal{U}, \Omega^*)$ is a number of copies of $C^*(\mathcal{U}, \Omega^*)$ and the differential operator D on the double complex $C^*(\mathcal{U}, \Omega^*)$ induces an operator on $H^*(F) \otimes C^*(\mathcal{U}, \Omega^*)$ whose cohomology is

$$H^*(F) \otimes H_D\{C^*(\mathcal{U}, \Omega^*)\} = H^*(F) \otimes H^*(M).$$

Since the D -cohomology of $C^*(\pi^{-1}\mathcal{U}, \Omega^*)$ is $H^*(E)$, if we can show that

$$\begin{array}{c} C^*(\pi^{-1}\mathcal{U}, \Omega^*) \\ \uparrow \pi_{\mathcal{U}}^* \\ H^*(F) \otimes C^*(\mathcal{U}, \Omega^*) \end{array}$$

induces an isomorphism in D -cohomology, the Künneth formula will follow.

The proof now divides into two steps:

Step 1.

For a good cover \mathcal{U} , the map $\pi_{\mathcal{U}}^*$ induces an isomorphism in H_* of these complexes.

Step 2.

Whenever a homomorphism $f: K \rightarrow K'$ of double complexes induces H_d -isomorphism, it also induces H_D -isomorphism. (By a homomorphism of double complexes, we mean a vector-space homomorphism which preserves bidegrees and commutes with d and δ .)

PROOF OF STEP 1. The p^{th} column $C^p(\pi^{-1}\mathcal{U}, \Omega^*)$ consists of forms on the $(p+1)$ -fold intersections $\coprod \pi^{-1}U_{a_0 \dots a_p}$ and $C^p(\mathcal{U}, \Omega^*)$ consists of forms on $\coprod U_{a_0 \dots a_p}$. The d -cohomology of $C^p(\pi^{-1}\mathcal{U}, \Omega^*)$ is

$$(9.12.1) \quad \prod H^*(\pi^{-1}U_{a_0 \dots a_p}) \simeq H^*(F) \otimes \prod H^*(U_{a_0 \dots a_p}),$$

the isomorphism being given by the wedge product of pullbacks. So π_{\sharp}^* induces an isomorphism of the d -cohomology of $C^*(\pi^{-1}\mathcal{U}, \Omega^*)$ and $H^*(F) \otimes C^*(\mathcal{U}, \Omega^*)$. \square

Exercise 9.13. Give a proof of Step 2.

REMARK. This argument for the Künneth formula also proves the Leray-Hirsch theorem (5.11), but again instead of assuming that M has a finite good cover, we require the cohomology of F to be finite-dimensional. If both M and F have infinite-dimensional cohomology, the isomorphism in (9.12.1) may not be valid.

The following example shows that some sort of finiteness hypothesis is necessary for the Künneth formula or the Leray-Hirsch theorem to hold.

EXAMPLE 9.14 (Counterexample to the Künneth formula when both M and F have infinite-dimensional cohomology). Let M and F each be the set \mathbb{Z}^+ of all positive integers. Then

$$H^0(M \times F) = \{\text{square matrices of real numbers } (a_{ij}), i, j \in \mathbb{Z}^+\}.$$

But $H^0(M) \otimes H^0(F)$ consists of finite sums of matrices (a_{ij}) of rank 1. These two vector spaces are not equal, since a finite sum of matrices of rank 1 has finite rank, but $H^0(M \times F)$ contains matrices of infinite rank.

§10 Presheaves and Čech Cohomology

Presheaves

The functor $\Omega^*(\)$ which assigns to every open set U on a manifold the differential forms on U is an example of a *presheaf*. By definition a *presheaf* \mathcal{F} on a topological space X is a function that assigns to every open set U in

X an abelian group $\mathcal{F}(U)$ and to every inclusion of open sets

$$i_V^U : V \rightarrow U$$

a group homomorphism, called the *restriction*,

$$\mathcal{F}(i_V^U) : \mathcal{F}(U) \rightarrow \mathcal{F}(V)$$

satisfying the following properties:

- (a) $\mathcal{F}(i_V^V) = \text{identity map}$
- (b) transitivity: $\mathcal{F}(i_V^W) \mathcal{F}(i_V^U) = \mathcal{F}(i_V^W)$.

The restriction $\mathcal{F}(i_V^U) : \mathcal{F}(U) \rightarrow \mathcal{F}(V)$ is often denoted ρ_V^U . A *homomorphism* of two presheaves, $f : \mathcal{F} \rightarrow \mathcal{G}$, is a collection of maps $f_U : \mathcal{F}(U) \rightarrow \mathcal{G}(U)$ which commute with the restrictions:

$$\begin{array}{ccc} \mathcal{F}(U) & \xrightarrow{f_U} & \mathcal{G}(U) \\ \rho_V^U \downarrow & & \downarrow \rho_V^U \\ \mathcal{F}(V) & \xrightarrow{f_V} & \mathcal{G}(V) \end{array}$$

Let $\text{Open}(X)$ be the category whose objects are the open sets in X and whose morphisms are inclusions of open sets. In functorial language, a presheaf is simply a contravariant functor from the category $\text{Open}(X)$ to the category of Abelian groups, and a homomorphism of two presheaves, $f : \mathcal{F} \rightarrow \mathcal{G}$, is a *natural transformation* from the functor \mathcal{F} to the functor \mathcal{G} .

The *trivial presheaf* with group G is the presheaf \mathcal{F} which associates to every *connected* open set the group G and to every inclusion $V \subset U$ the identity map: $\mathcal{F}(U) \rightarrow \mathcal{F}(V)$. We say that a presheaf is a *constant presheaf* if it is isomorphic to the trivial presheaf, and that it is a *locally constant presheaf* if it is locally isomorphic to the trivial presheaf, i.e., every point has a neighborhood U so that $\mathcal{F}|_U$ is a constant presheaf.

EXAMPLE 10.1. Let $\pi : E \rightarrow M$ be a fiber bundle with fiber F . Define a presheaf \mathcal{H}^q on M by $\mathcal{H}^q(U) = H^q(\pi^{-1}U)$. For U contractible, $H^q(\pi^{-1}U) = H^q(F)$ by the Künneth formula, and if $V \subset U$ with V connected, then the restriction $\rho_V^U : H^q(\pi^{-1}U) \rightarrow H^q(\pi^{-1}V)$ is the identity. Therefore \mathcal{H}^q is a locally constant presheaf on M .

Now consider the trivial bundle $E = M \times F$. Assume that F has finite-dimensional cohomology. Since $\mathcal{H}^q(M) = H^q(E) = \bigoplus_{i+j=q} (H^i(M) \otimes H^j(F))$ is not usually equal to $H^q(F)$, a *locally constant presheaf on M need not be a constant presheaf, even if M is simply connected.**

* However, a locally constant *sheaf* on a simply connected space is constant.

Čech Cohomology

Let $\mathcal{U} = \{U_\alpha\}_{\alpha \in J}$ be an open cover of the topological space X . The 0-cochains on \mathcal{U} with values in the presheaf \mathcal{F} are functions which assign to each open set U_α an element of $\mathcal{F}(U_\alpha)$, i.e., $C^0(\mathcal{U}, \mathcal{F}) = \prod_{\alpha \in J} \mathcal{F}(U_\alpha)$. Similarly the 1-cochains are elements of

$$C^1(\mathcal{U}, \mathcal{F}) = \prod_{\alpha < \beta} \mathcal{F}(U_\alpha \cap U_\beta)$$

and so on.

The sequence of inclusions

$$U_\alpha \begin{array}{c} \xleftarrow{\partial_0} \\ \xleftarrow{\partial_1} \end{array} U_{\alpha\beta} \xleftarrow{\quad} \cdots$$

gives rise to a sequence of group homomorphisms

$$\prod \mathcal{F}(U_\alpha) \rightrightarrows \prod \mathcal{F}(U_{\alpha\beta}) \rightrightarrows \cdots$$

We define $\delta : C^p(\mathcal{U}, \mathcal{F}) \rightarrow C^{p+1}(\mathcal{U}, \mathcal{F})$ to be the alternating difference of the $\mathcal{F}(\delta_i)$'s; for example,

$$\delta : C^0(\mathcal{U}, \mathcal{F}) \rightarrow C^1(\mathcal{U}, \mathcal{F})$$

is given by

$$\delta = \mathcal{F}(\partial_0) - \mathcal{F}(\partial_1).$$

In general

$$\delta : C^p(\mathcal{U}, \mathcal{F}) \rightarrow C^{p+1}(\mathcal{U}, \mathcal{F})$$

is given by

$$\delta = \mathcal{F}(\partial_0) - \mathcal{F}(\partial_1) + \cdots + (-1)^{p+1} \mathcal{F}(\partial_{p+1}).$$

Explicitly, if $\omega \in C^p(\mathcal{U}, \mathcal{F})$, then

$$(10.2) \quad (\delta\omega)_{\alpha_0 \dots \alpha_{p+1}} = \sum_{i=0}^{p+1} (-1)^i \omega_{\alpha_0 \dots \hat{\alpha}_i \dots \alpha_{p+1}}$$

where on the right-hand side the restriction of $\omega_{\alpha_0 \dots \hat{\alpha}_i \dots \alpha_{p+1}}$ to $U_{\alpha_0 \dots \alpha_{p+1}}$ is suppressed. It follows from the transitivity of the restriction homomorphism that $\delta^2 = 0$ (proof as in Proposition 8.3). Thus $C^*(\mathcal{U}, \mathcal{F})$ is a differential complex with differential operator δ . The cohomology of this complex, denoted by $H_* C^*(\mathcal{U}, \mathcal{F})$ or $H^*(\mathcal{U}, \mathcal{F})$, is called the Čech cohomology of the cover \mathcal{U} with values in \mathcal{F} .

REMARK 10.3. If \mathcal{F} is a covariant functor from the category $\text{Open}(X)$ to the category of Abelian groups, and \mathcal{U} is an open cover of X , one can define analogously a chain complex $C_*(\mathcal{U}, \mathcal{F})$ and its homology $H_*(\mathcal{U}, \mathcal{F})$. Apart from the direction of the arrows, the only difference from the case of a

presheaf is in the definition of the coboundary operator $\delta : C_p(\mathcal{U}, \mathcal{F}) \rightarrow C_{p-1}(\mathcal{U}, \mathcal{F})$, which is now given by

$$(\delta\omega)_{\alpha_0 \dots \alpha_{p-1}} = \sum_{\alpha} \omega_{\alpha\alpha_0 \dots \alpha_{p-1}}.$$

One verifies easily that this δ also satisfies $\delta^2 = 0$. The functor \mathcal{H}_c^q which associates to every open set U on a manifold the compact cohomology $H_c^q(U)$ is covariant.

Because of the antisymmetry convention on the subscripts, in this formula there is no sign in the sum. Of course, if we had written each term $\omega_{\alpha_0 \dots \alpha_{p-1}}$ with the subscript α inserted in the i -th place, then there would be a sign: $\sum_i (-1)^i \omega_{\alpha_0 \dots \alpha \dots \alpha_{p-1}}$.

Returning to the discussion of the Čech cohomology of a presheaf \mathcal{F} , recall that the cover $\mathcal{B} = \{V_\beta\}_{\beta \in J}$ is a refinement of the cover $\mathcal{U} = \{U_\alpha\}_{\alpha \in I}$, written $\mathcal{U} > \mathcal{B}$, if there is a map $\phi : J \rightarrow I$ such that $V_\beta \subset U_{\phi(\beta)}$. The refinement ϕ induces a map

$$\phi^* : C^q(\mathcal{U}, \mathcal{F}) \rightarrow C^q(\mathcal{B}, \mathcal{F})$$

in the obvious manner:

$$(\phi^* \omega)(V_{\beta_0} \dots V_{\beta_q}) = \omega(U_{\phi(\beta_0)} \dots U_{\phi(\beta_q)}).$$

Lemma 10.4.1. ϕ^* is a chain map, i.e., it commutes with δ .

PROOF.
$$\begin{aligned} (\delta(\phi^* \omega))(V_{\beta_0} \dots V_{\beta_{q+1}}) &= \sum (-1)^i (\phi^* \omega)(V_{\beta_0 - \beta_1 - \dots - \beta_{i-1}}) \\ &= \sum (-1)^i \omega(U_{\phi(\beta_0)} \dots \widehat{U_{\phi(\beta_i)}} \dots U_{\phi(\beta_{q+1})}) \\ (\phi^* \delta\omega)(V_{\beta_0} \dots V_{\beta_{q+1}}) &= (\delta\omega)(U_{\phi(\beta_0)} \dots U_{\phi(\beta_{q+1})}) \\ &= \sum (-1)^i \omega(U_{\phi(\beta_0)} \dots \widehat{U_{\phi(\beta_i)}} \dots U_{\phi(\beta_{q+1})}). \end{aligned}$$

□

Lemma 10.4.2. Given $\mathcal{U} = \{U_\alpha\}_{\alpha \in I}$ an open cover and $\mathcal{B} = \{V_\beta\}_{\beta \in J}$ a refinement, if ϕ and ψ are two refinement maps: $J \rightarrow I$, then there is a homotopy operator between ϕ^* and ψ^* .

PROOF. Define $K : C^q(\mathcal{U}, \mathcal{F}) \rightarrow C^{q-1}(\mathcal{B}, \mathcal{F})$ by

$$(K\omega)(V_{\beta_0} \dots V_{\beta_{q-1}}) = \sum (-1)^i \omega(U_{\phi(\beta_0)} \dots \widehat{U_{\phi(\beta_i)}} \dots U_{\psi(\beta_{q-1})}).$$

Exercise 10.5. Show that

$$\psi^* - \phi^* = \delta K + K\delta.$$

□

A *direct system of groups* is a collection of groups $\{G_i\}_{i \in I}$ indexed by a directed set I such that for any pair $a > b$ there is a group homomorphism $f_b^a : G_a \rightarrow G_b$ satisfying

- (1) $f_a^a = \text{identity}$,
- (2) $f_c^a = f_c^b \circ f_b^a$.

On the disjoint union $\coprod G_i$ we introduce an equivalence relation \sim by decreeing two elements g in G_a and h in G_b to be equivalent if there is some c in I such that $f_c^a(g) = f_c^b(h)$ in G_c . The *direct limit* of the direct system, denoted by $\lim_{i \in I} G_i$, is the quotient of $\coprod G_i$ by the equivalence relation \sim ; in other words, two elements of $\coprod G_i$ represent the same element in the direct limit if they are "eventually equal".

It follows from the two lemmas above that if $\mathcal{U} > \mathcal{B}$, then there is a well-defined map in cohomology

$$H^*(\mathcal{U}, \mathcal{F}) \rightarrow H^*(\mathcal{B}, \mathcal{F}),$$

making $\{H^*(\mathcal{U}, \mathcal{F})\}_{\mathcal{U}}$ into a direct system of groups. The direct limit of this direct system.

$$H^*(X, \mathcal{F}) = \lim_{\mathcal{U}} H^*(\mathcal{U}, \mathcal{F})$$

is the Čech cohomology of X with values in the presheaf \mathcal{F} .

Proposition 10.6. *Let \mathbb{R} be the constant presheaf on a manifold M . Then the Čech cohomology of M with values in \mathbb{R} is isomorphic to the de Rham cohomology.*

PROOF. Since the good covers are cofinal in the set of all covers of M (Corollary 5.2), we can use only good covers in the direct limit

$$H^*(M, \mathbb{R}) = \lim_{\mathcal{U}} H^*(\mathcal{U}, \mathbb{R}).$$

By Theorem 8.9,

$$H^*(\mathcal{U}, \mathbb{R}) \simeq H_{DR}^*(M)$$

for any good cover of M . Therefore, there is an isomorphism

$$H^*(M, \mathbb{R}) \simeq H_{DR}^*(M).$$

□

Exercise 10.7 (Cohomology with Twisted Coefficients). Let \mathcal{F} be the presheaf on S^1 which associates to every open set the group \mathbb{Z} . We define the

restriction homomorphism on the good cover $\mathcal{U} = \{U_0, U_1, U_2\}$ (Figure 10.1) by

$$\rho_{01}^0 = \rho_{01}^1 = 1,$$

$$\rho_{12}^1 = \rho_{12}^2 = 1,$$

$$\rho_{02}^2 = -1, \rho_{02}^0 = 1,$$

where ρ_{ij}^k is the restriction from U_i to $U_i \cap U_j$. Compute $H^*(\mathcal{U}, \mathcal{F})$.

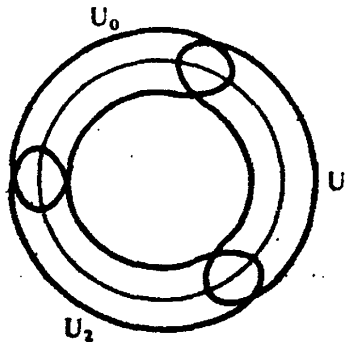

Figure 10.1

§11 Sphere Bundles

Let $\pi: E \rightarrow M$ be a fiber bundle with fiber the sphere S^n , $n \geq 1$. As the structure group we normally take the largest group possible, namely the diffeomorphism group $\text{Diff}(S^n)$, but sometimes we also consider sphere bundles with structure group $O(n+1)$. These two notions are not equivalent; there are examples of sphere bundles whose structure groups cannot be reduced to the orthogonal group. Thus, every vector bundle defines a sphere bundle, but not conversely. By the Leray-Hirsch theorem if there is a closed global n -form on E whose restriction to each fiber generates the cohomology of the fiber, then the cohomology of E is

$$H^*(E) = H^*(M) \otimes H^*(S^n).$$

It is therefore of interest to know when such a global form exists.

In Section 6 we constructed the global angular form ψ on a rank 2 vector bundle with structure group $SO(2)$. This form ψ was seen to have the following two properties:

- (a) ψ restricts to the volume form on each fiber
- (b) $d\psi = -\pi^*e$

where e is the Euler class. Exactly the same procedure defines the angular form and the Euler class of a circle bundle with structure group $SO(2)$.

Consequently, for such a bundle also, if the Euler class vanishes, then ψ is closed and satisfies the condition of the Leray-Hirsch theorem.

We now consider more generally a sphere bundle with structure group $\text{Diff}(S^n)$ or $O(n+1)$. We will see that the existence of a global form as above entails overcoming two obstructions: orientability and the Euler class.

Orientability

In this section the base space of the bundle is assumed to be connected. A sphere bundle with fiber S^n , $n \geq 1$, is said to be *orientable* if for each fiber F_x it is possible to choose a generator $[\sigma_x]$ of $H^n(F_x)$ satisfying the *local compatibility condition*: around any point there is a neighborhood U and a generator $[\sigma_U]$ of $H^n(E|_U)$ such that for any x in U , $[\sigma_U]$ restricted to the fiber F_x is the chosen generator $[\sigma_x]$; equivalently, there is an open cover $\{U_\alpha\}$ of M and generators $[\sigma_\alpha]$ of $H^n(E|_{U_\alpha})$ so that $[\sigma_\alpha] = [\sigma_\beta]$ in $H^n(E|_{U_\alpha \cap U_\beta})$.

Since a generator of the top cohomology of a fiber is an n -form with total integral 1, there are two possible generators, depending on the orientation of the fiber. A priori all that one could say is that $[\sigma_\alpha] = \pm[\sigma_\beta]$ on $U_\alpha \cap U_\beta$. For an orientable sphere bundle either choice of a consistent system of generators is called an *orientation* of the sphere bundle. A bundle with a given orientation is said to be *oriented*. An S^0 -bundle over a manifold M is a double cover of M ; such a bundle over a connected base space is said to be *orientable* if and only if the total space has two connected components.

CAVEAT. The fact that the cohomology classes $\{[\sigma_\alpha]\}$ agree on overlaps does not mean that they piece together to form a global cohomology class. A global cohomology class must be represented by a global form; the equality of cohomology classes $[\sigma_\alpha] = [\sigma_\beta]$ implies only that the forms σ_α and σ_β differ by an exact form.

Recall that in Section 7 we called a vector bundle of rank $n+1$ orientable if and only if it can be given by transition functions with values in $SO(n+1)$. We now study the relation between the orientability of a sphere bundle and the orientability of a vector bundle.

Let E be a vector bundle of rank $n+1$ endowed with a Riemannian metric so that its structure group is reduced to $O(n+1)$. Its unit sphere bundle $S(E)$ is the fiber bundle whose fiber at x consists of all the unit vectors in E_x and whose transition functions are the same as those of E . $S(E)$ is an S^n -bundle with structure group $O(n+1)$.

REMARK 11.1. Fix an orientation on the sphere S^n . If the linear transformation g is in the special orthogonal group $SO(n+1)$ and $[\sigma]$ is a

generator of $H^n(S^n)$ with $\int_{S^n} \sigma = 1$, then the image $g(S^n)$ is the sphere S^n with the same orientation, so that

$$\int_{S^n} g^* \sigma = \int_{g(S^n)} \sigma = \int_{S^n} \sigma = 1.$$

Thus for an orthogonal transformation g , $g^* \sigma$ and σ represent the same cohomology class if and only if g has positive determinant.

Proposition 11.2. *A vector bundle E is orientable if and only if its sphere bundle $S(E)$ is orientable.*

PROOF. (\Rightarrow) Fix a generator σ on S^n and fix a trivialization $\{(U_\alpha, \phi_\alpha)\}$ for E so that the transition functions $g_{\alpha\beta}$ assume values in $SO(n+1)$. Let

$$\rho_\alpha: U_\alpha \times S^n \rightarrow S^n$$

be the projection and let $\pi^{-1}(x)$ be the fiber of the sphere bundle $\pi: S(E) \rightarrow M$ at x . Define $[\sigma_\alpha]$ in $H^n(S(E)|_{U_\alpha})$ by

$$[\sigma_\alpha] = \phi_\alpha^* \rho_\alpha^* [\sigma].$$

To avoid cumbersome notations we will write $[\sigma_\alpha]|_x$ and $\phi_\alpha|_x$ for the restrictions $[\sigma_\alpha]|_{\pi^{-1}(x)}$ and $\phi_\alpha|_{\pi^{-1}(x)}$ respectively. Then for every x in $U_\alpha \cap U_\beta$,

$$[\sigma_\alpha]|_x = (\phi_\alpha|_x)^* [\sigma].$$

It follows that if $x \in U_\alpha \cap U_\beta$, then

$$\begin{aligned} [\sigma_\beta]|_x &= (\phi_\beta|_x)^* [\sigma] \\ &= (\phi_\beta|_x)^* ((\phi_\alpha|_x)^{-1})^* [\sigma_\alpha]|_x \\ &= g_{\alpha\beta}(x)^* [\sigma_\alpha]|_x \\ &= [\sigma_\alpha]|_x, \end{aligned}$$

since $g_{\alpha\beta}(x)$ has positive determinant. Therefore, $[\sigma_\beta] = [\sigma_\alpha]$ on $U_\alpha \cap U_\beta$ and the sphere bundle $S(E)$ is orientable.

(\Leftarrow) Conversely, let $\{U_\alpha, [\sigma_\alpha]\}$ be an orientation on the sphere bundle $S(E)$ and let (S^n, σ) be an oriented sphere in \mathbb{R}^{n+1} , where σ is a nontrivial top form on S^n . Choose the trivializations for $S(E)$

$$\phi_\alpha: S(E)|_{U_\alpha} \xrightarrow{\sim} U_\alpha \times S^n$$

in such a way that ϕ_α preserves the metric and $\phi_\alpha^* \rho_\alpha^* [\sigma] = [\sigma_\alpha]$. Then at any point x in $U_\alpha \cap U_\beta$, the transition function $g_{\alpha\beta}(x)$ pulls $[\sigma]$ to itself and so $g_{\alpha\beta}(x)$ must be in $SO(n+1)$. \square

REMARK 11.3. Since $SO(1) = \{1\}$, a line bundle L over a connected base space is orientable if and only if it is trivial. In this case the sphere bundle $S(L)$ consists of two connected components.

Proposition 11.4. *A vector bundle E is orientable if and only if its determinant bundle $\det E$ is orientable.*

PROOF. Let $\{g_{\alpha\beta}\}$ be the transition functions of E . Then the transition functions of $\det E$ are $\{\det g_{\alpha\beta}\}$. An orthogonal matrix $g_{\alpha\beta}$ assumes values in $SO(n+1)$ if and only if $\det g_{\alpha\beta}$ is positive, so the proposition follows. \square

Whether E is orientable or not, the 0-sphere bundle $S(\det E)$ is always a 2-sheeted covering of M . Combining Corollary 11.3 and Proposition 11.4, we see that over a connected base space a vector bundle E is orientable if and only if $S(\det E)$ is disconnected. Since a simply connected base space cannot have any connected covering space of more than one sheet, we have proven the following.

Proposition 11.5. *Every vector bundle over a simply connected base space is orientable.*

In particular, the tangent bundle of a simply connected manifold is orientable. Since a manifold is orientable if and only if its tangent bundle is (Example 6.3), this gives

Corollary 11.6. *Every simply connected manifold is orientable.*

The Euler Class of an Oriented Sphere Bundle

We first consider the case of a circle bundle $\pi : E \rightarrow M$ with structure group $\text{Diff}(S^1)$. As stated in the introduction to this section, our problem is to find a closed global 1-form on E which restricts to a generator of the cohomology on each fiber. As a first approximation, in each U_α of a good cover $\{U_\alpha\}$ of M we choose a generator $[\sigma_\alpha]$ of $H^1(E|_{U_\alpha})$. The collection $\{\sigma_\alpha\}$ is an element $\sigma^{0,1}$ in the double complex $C^*(\pi^{-1}\mathcal{U}, \Omega^*)$:

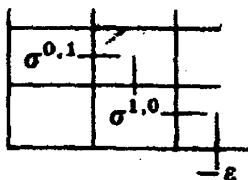

From the isomorphism between the cohomology of E and the cohomology of this double complex,

$$H_{DR}^*(E) \simeq H_D\{C^*(\pi^{-1}\mathcal{U}, \Omega^*)\},$$

we see that to find a global form which restricts to the d -cohomology class of $\sigma^{0,1}$ it suffices to extend $\sigma^{0,1}$ to a D -cocycle. The first step of the extension requires that $(\delta\sigma^{0,1})_{\alpha\beta} = \sigma_\beta - \sigma_\alpha$ be exact, i.e., $[\sigma_\alpha] = [\sigma_\beta]$ for all α, β .

This is precisely the orientability condition. Assume the bundle E to be oriented with orientation $\sigma^{0,1}$, so that $\delta\sigma^{0,1} = d\sigma^{1,0}$ for some $\sigma^{1,0}$ in $C^1(\pi^{-1}\mathcal{U}, \Omega^0)$. Then $\sigma^{0,1} + \sigma^{1,0}$ is a D -cocycle if and only if $\delta\sigma^{1,0} = 0$. Since

$$d(\delta\sigma^{1,0}) = \delta(d\sigma^{1,0}) = \delta(\delta\sigma^{0,1}) = 0,$$

$\delta\sigma^{1,0}$ actually comes from an element $-\varepsilon$ of the cochain group $C^2(\pi^{-1}\mathcal{U}, \mathbb{R})$. Now since the open covers \mathcal{U} and $\pi^{-1}\mathcal{U}$ have the same combinatorics, i.e., $\pi^{-1}U_{\alpha_0 \dots \alpha_p}$ is nonempty if and only if $U_{\alpha_0 \dots \alpha_p}$ is, $C^*(\pi^{-1}\mathcal{U}, \mathbb{R}) = C^*(\mathcal{U}, \mathbb{R})$ and we may regard ε as an element of $C^2(\mathcal{U}, \mathbb{R})$. In fact, because $\delta\varepsilon = 0$, ε defines a Čech cohomology class in $H^2(\mathcal{U}, \mathbb{R})$. By the isomorphism between the Čech cohomology of a good cover and de Rham cohomology, ε corresponds to a cohomology class $e(E)$ in $H^2(M)$. For a circle bundle with structure group $SO(2)$, this class turns out to be the Euler class of Section 6, as will be shown later. So for an oriented circle bundle E with structure group $\text{Diff}(S^1)$ we also call $e(E)$ the *Euler class*.

The discussion above generalizes immediately to any sphere bundle with fiber S^n , $n \geq 1$. Such a sphere bundle is orientable if and only if it is possible to find an element $\sigma^{0,n}$ in $C^0(\pi^{-1}\mathcal{U}, \Omega^n)$ which extends one step down toward being a D -cocycle:

$$\delta\sigma^{0,n} = d\sigma^{1,n-1} = -D^n\sigma^{1,n-1}.$$

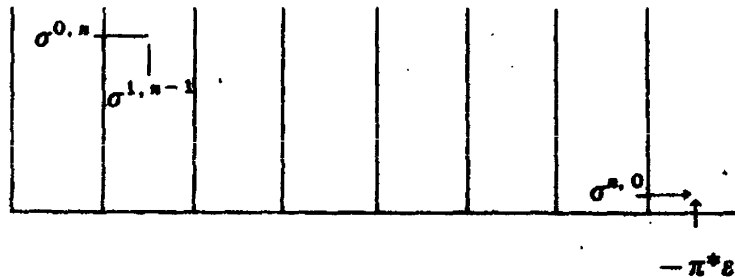

There is no obstruction to extending $\sigma^{1,n-1}$ one step further, since every closed $(n-1)$ -form on $E|_{U_{\alpha_0, \alpha_1, \alpha_2}}$ is exact. In general, extension is possible until we hit a nontrivial cohomology of the fiber. Thus for an oriented sphere bundle E we can extend all the way down to $\sigma^{n,0}$ in such a manner that if

$$\sigma = \sigma^{0,n} + \sigma^{1,n-1} + \dots + \sigma^{n,0},$$

then

$$D\sigma = \delta\sigma^{n,0}.$$

Since $d(\delta\sigma^{n,0}) = \delta(d\sigma^{n,0}) = \pm \delta(\delta\sigma^{n-1,1}) = 0$,

$$D\sigma = \delta\sigma^{n,0} = i(-\varepsilon)$$

for some ε in $C^{n+1}(\pi^{-1}\mathcal{U}, \mathbb{R}) \simeq C^{n+1}(\mathcal{U}, \mathbb{R})$, where i is the inclusion $C^{n+1}(\mathcal{U}, \mathbb{R}) \rightarrow C^{n+1}(\mathcal{U}, \Omega^0)$. Clearly $\delta\varepsilon = 0$, so ε defines a cohomology class $e(E)$ in $H^{n+1}(\mathcal{U}, \mathbb{R}) \simeq H^{n+1}(M)$, the *Euler class* of the oriented S^n -bundle E .

with orientation $\sigma^{0,n}$. The Euler class of an oriented S^0 -bundle is defined to be 0. Note that the Euler class depends on the orientation $\{[\sigma_a]\}$ of E ; the opposite orientation would give $-e(E)$ instead.

If E is an oriented vector bundle, the complement E^0 of its zero section has the homotopy type of an oriented sphere bundle. The Euler class of E is defined to be that of E^0 . Equivalently, if E is endowed with a Riemannian metric, then the unit sphere bundle $S(E)$ of E makes sense and we may define the Euler class of E to be that of its unit sphere bundle. This latter definition is independent of the metric and in fact agrees with the definition in terms of E^0 , since for any metric on E , the unit sphere bundle $S(E)$ has the homotopy type of E^0 .

In the next two propositions we show that the Euler class is well defined.

Proposition 11.7. *For a given orientation $\{[\sigma_a]\}$ the Euler class is independent of the choice of $\sigma^{j,n-j}$, $j = 1, \dots, n$.*

PROOF.

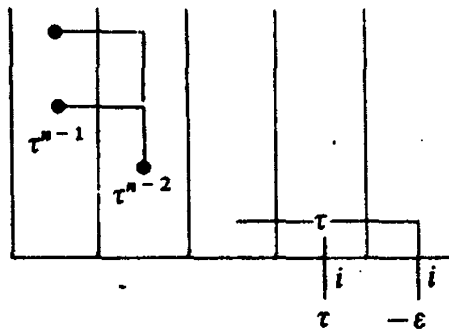

Let $\bar{\sigma}^{0,n}$ be another cochain in $C^0(\pi^{-1}U, \Omega^n)$ which represents the orientation $\{[\sigma_a]\}$. Then $\bar{\sigma}^{0,n} - \sigma^{0,n} = d\tau^{n-1}$ for some τ^{n-1} in $C^0(\pi^{-1}U, \Omega^{n-1})$. Since $d(\delta\tau^{n-1})$ and $d(\bar{\sigma}^{1,n-1} - \sigma^{1,n-1})$ are equal, $\delta\tau^{n-1}$ and $\bar{\sigma}^{1,n-1} - \sigma^{1,n-1}$ differ by $d\tau^{n-2}$ for some τ^{n-2} in $C^1(\pi^{-1}U, \Omega^{n-2})$. Again,

$$d(\delta\tau^{n-2}) = -d(\bar{\sigma}^{2,n-2} - \sigma^{2,n-2}),$$

so

$$(\delta\tau^{n-2}) - (\bar{\sigma}^{2,n-2} - \sigma^{2,n-2}) = d\tau^{n-3}$$

for some τ^{n-3} in $C^2(\pi^{-1}U, \Omega^{n-3})$. Eventually we get

$$\delta\tau^0 - (\bar{\sigma}^{n,0} - \sigma^{n,0}) = i\tau, \tau \in C^n(\pi^{-1}U, \mathbb{R}).$$

Taking δ of both sides, we have

$$\bar{\varepsilon} - \varepsilon = \delta\tau.$$

So $\bar{\varepsilon}$ and ε define the same Čech cohomology class. □

Proposition 11.8. *The Euler class $e(E)$ is independent of the choice of the good cover.*

PROOF. Write $\varepsilon_{\mathcal{U}}$ for the cocycle in $H^{n+1}(\mathcal{U}, \mathbb{R})$ which defines the Euler class in terms of the good cover \mathcal{U} . If a good cover \mathcal{B} is a refinement of \mathcal{U} , then there is a commutative diagram

$$\begin{array}{ccc} H^{n+1}(\mathcal{U}, \mathbb{R}) & \longrightarrow & H^{n+1}(\mathcal{B}, \mathbb{R}) \\ & \searrow \cong & \swarrow \cong \\ & & H_{DR}^{n+1}(M) \end{array}$$

$\varepsilon_{\mathcal{U}}$ and $\varepsilon_{\mathcal{B}}$ give the same element in $H_{DR}^{n+1}(M)$, because if we choose the $\sigma^{0,n}$ on $\pi^{-1}\mathcal{B}$ to be the restriction of the $\sigma^{0,n}$ on $\pi^{-1}\mathcal{U}$, the cocycle $\varepsilon_{\mathcal{B}}$ in $C^{n+1}(\mathcal{B}, \mathbb{R})$ will be the restriction of the cocycle $\varepsilon_{\mathcal{U}}$ in $C^{n+1}(\mathcal{U}, \mathbb{R})$, so that as elements of the Čech cohomology $H^{n+1}(M, \mathbb{R})$ they are equal. Given two arbitrary good covers \mathcal{U} and \mathcal{B} , we can take a common refinement \mathcal{B} ; then $\varepsilon_{\mathcal{U}} = \varepsilon_{\mathcal{B}} = \varepsilon_{\mathcal{B}}$ in $H^{n+1}(M, \mathbb{R})$. So the Euler class is independent of the cover. □

If the Euler class vanishes, then the D -cocycle σ corresponds to a global form which restricts to the d -cohomology class of $\sigma^{0,n}$. In sum, then, there is a global form that restricts to a generator on each fiber if and only if

- (a) E is orientable, and
- (b) the Euler class $e(E)$ vanishes.

For E a product bundle, the extension stops at the $\sigma^{0,n}$ stage so that $\varepsilon = 0$. In this sense the Euler class is a measure of the twisting of an oriented sphere bundle. However, as we will see in the proposition below, E need not be a product bundle for its Euler class to vanish.

Proposition 11.9. *If the oriented sphere bundle E has a section, then its Euler class vanishes.*

PROOF. Let s be a section of E . It follows from $\pi \circ s = 1$ that $s^*\pi^* = 1$. We saw in the construction of the Euler class that

$$-\pi^*\varepsilon = D\sigma$$

for some D -cochain σ . Applying s^* to both sides gives

$$-\varepsilon = Ds^*\sigma,$$

so ε is a coboundary in $H^*(M)$. □

The converse of this proposition is not true. In general a cohomology class is too "coarse" an invariant to yield information on the existence of geometrical constructs. In (23.16) we will show the existence of a sphere bundle whose Euler class vanishes, but which does not admit any section.

We now show that for a circle bundle $\pi : E \rightarrow M$ with structure group $SO(2)$ the definitions of the Euler class in Section 6 and in this section agree. We briefly recall here the earlier construction. If θ_α is the angular coordinate over U_α , then $[d\theta_\alpha/2\pi]$ is a generator of $H^1(E|_{U_\alpha})$. Furthermore,

$$\frac{d\theta_\beta}{2\pi} - \frac{d\theta_\alpha}{2\pi} = \pi^* \frac{d\phi_{\alpha\beta}}{2\pi} = \pi^* \zeta_\beta - \pi^* \zeta_\alpha \text{ for some 1-form } \zeta_\alpha \text{ over } U_\alpha.$$

The Euler class of the circle bundle E was defined to be the cohomology class of the global form $\{d\xi_\alpha\}$.

In the present context these cochains fit into the double complex $C^*(\pi^{-1}\mathcal{U}, \Omega^*)$ of E as shown in the diagram below.

$$\begin{array}{ccc}
 & & \\
 \Omega^*(E) & \begin{array}{|c|c|c|} \hline & & \\ \hline \frac{d\theta_\alpha}{2\pi} & \frac{\pi^* d\phi_{\alpha\beta}}{2\pi} & \\ \hline & \frac{\pi^* \phi_{\alpha\beta}}{2\pi} & -\pi^* \varepsilon \\ \hline \end{array} & C^*(\pi^{-1}\mathcal{U}, \Omega^*) \\
 & & \uparrow \\
 & & -\pi^* \varepsilon \\
 & C^*(\pi^{-1}\mathcal{U}, \mathbb{R}) &
 \end{array}$$

By the explicit isomorphism between de Rham and Čech (Proposition 9.8), the differential form on M corresponding to the Čech cocycle ε is $(-D^*K)^2\varepsilon$. Since $\xi_\beta - \xi_\alpha = (1/2\pi) d\phi_{\alpha\beta}$, $\delta\xi = (1/2\pi) d\phi$, so by (8.7), we may take ξ to be $(1/2\pi) Kd\phi$. Also note that since $\delta(\phi/2\pi) = -\varepsilon$,

$$-K\varepsilon = \phi/2\pi \text{ (modulo a } \delta\text{-coboundary).}$$

Hence

$$\begin{aligned}
 (-D^*K)^2\varepsilon &= -dKdK\varepsilon \\
 &= dKd((\phi/2\pi) + \delta\tau) \text{ for some } \tau \\
 &= dKd(\phi/2\pi) + dKd\delta\tau \\
 &= d\xi + dKd\delta\tau.
 \end{aligned}$$

Here

$$\begin{aligned}
 dKd\delta\tau &= dK\delta d\tau && \text{because } d \text{ commutes with } \delta \\
 &= d(1 - \delta K)d\tau && \text{by (8.7)} \\
 &= -\delta dKd\tau.
 \end{aligned}$$

Since $Kd\tau \in \Omega^1(M)$, $dKd\tau$ is a global exact form, so $\delta dKd\tau = 0$. Hence $(-D^*K)^2\varepsilon = d\xi$, showing that the two definitions of the Euler class could be made to agree on the level of forms.

The Global Angular Form

In Section 6 we exhibited on an oriented circle bundle the global angular form ψ which has the following properties:

- (a) its restriction to each fiber is a generator of the cohomology of the fiber;
- (b) $d\psi = -\pi^*e$, where e represents the Euler class of the circle bundle.

Using the collating formula (9.5) we will now construct such a form on any oriented S^n -bundle.

Let $\mathcal{U} = \{U_\alpha\}$ be an open cover of M . Recall that the Euler class of E is defined by the following diagram:

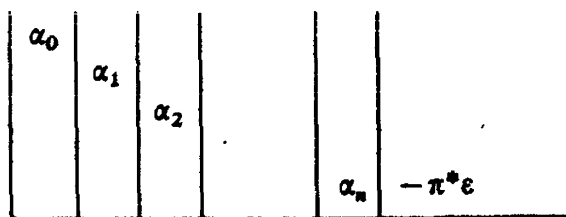

where $\alpha_0 \in C^0(\pi^{-1}\mathcal{U}, \Omega^n)$ is the orientation of E ,

$$\delta\alpha_i = -D^*\alpha_{i+1}, \quad i = 0, \dots, n-1,$$

and

$$\delta\alpha_n = -\pi^*e.$$

Hence

$$D(\alpha_0 + \dots + \alpha_n) = -\pi^*e.$$

Here α_i is what we formerly wrote as $\sigma^{i, n-i}$.

If $\{\rho_\alpha\}$ is a partition of unity subordinate to the open cover $\mathcal{U} = \{U_\alpha\}$, then $\{\pi^*\rho_\alpha\}$ is a partition of unity subordinate to the inverse cover $\pi^{-1}\mathcal{U} = \{\pi^{-1}U_\alpha\}$. Using these data we can define a homotopy operator K on the double complex $C^*(\mathcal{U}, \Omega^*)$ and also one on $C^*(\pi^{-1}\mathcal{U}, \Omega^*)$ as in (8.6). We denote both operators by K . Both K satisfy

$$\delta K + K\delta = 1.$$

Since

$$\begin{aligned} (K\pi^*\omega)_{\alpha_0 \dots \alpha_{p-1}} &= \sum (\pi^*\rho_\alpha)(\pi^*\omega)_{\alpha_0 \dots \alpha_{p-1}} \\ &= \pi^* \sum \rho_\alpha \omega_{\alpha_0 \dots \alpha_{p-1}} \\ &= (\pi^*K\omega)_{\alpha_0 \dots \alpha_{p-1}}, \end{aligned}$$

K commutes with π^* .

Exercise 11.10. If $s : M \rightarrow E$ is a section, show that $Ks^* = s^*K$.

By the collating formula (9.5),

$$(11.11) \quad \psi = \sum_{i=0}^n (-1)^i (D''K)^i \alpha_i + (-1)^{n+1} K(D''K)^n (-\pi^* \varepsilon)$$

is a global form on E . Furthermore,

$$(11.12) \quad \begin{aligned} d\psi &= (-1)^{n+1} dK(D''K)^n (-\pi^* \varepsilon) \\ &= -\pi^* (-1)^{n+1} (D''K)^{n+1} \varepsilon \quad \text{since } \pi^* \text{ commutes with } D''K \\ &= -\pi^* \varepsilon \quad \text{by Proposition 9.8.} \end{aligned}$$

In formula (11.11) since the restriction of $\pi^*((-1)^{n+1} K(D''K)^n \varepsilon)$ to a fiber is 0, the restriction of the global form ψ to each fiber is d -cohomologous to $\alpha_0|_{\text{fiber}}$, hence is a generator of the cohomology of the fiber. The global n -form ψ on the sphere bundle E satisfies the properties (a) and (b) stated earlier. We call it the *global angular form* on the sphere bundle.

Exercise 11.13. Use the existence of the global angular form ψ to prove Proposition 11.9.

Euler Number and the Isolated Singularities of a Section

Let $\pi : E \rightarrow M$ be an oriented $(k-1)$ -sphere bundle over a compact oriented manifold of dimension k . Since $H^k(M) \simeq \mathbb{R}$, the Euler class of E may be identified with the number $\int_M e(E)$, which is by definition the *Euler number* of E . The Euler number of the manifold M is defined to be that of its unit tangent bundle $S(T_M)$ relative to some Riemannian structure on M . While the Euler number of an orientable sphere bundle is defined only up to sign, depending on the orientations of both E and M , the Euler number of the orientable manifold M is unambiguous, since reversing the orientation of M also reverses that of the tangent bundle.

In general the sphere bundle E will not have a global section; however, there may be a section s over the complement of a finite number of points x_1, \dots, x_q in M . In fact, as we will show in Proposition 11.14, if the sphere bundle has structure group $O(k)$, then such a "partial" section s always exists. In this section we will explain how one may compute the Euler class of E in terms of the behavior of the section s near the singularities x_1, \dots, x_q .

Proposition 11.14. *Let $\pi : E \rightarrow M$ be a $(k-1)$ -sphere bundle over a compact manifold of dimension k . Suppose the structure group of E can be reduced to $O(k)$. Then E has a section over $M - \{x_1, \dots, x_q\}$ for some finite number of points in M .*

PROOF. Since the structure group of E is $O(k)$, we can form a Riemannian vector bundle E' of rank k whose unit sphere bundle is E . A section s' of E' over M gives rise to a partial section s of $E : s(x) = s'(x) / \|s'(x)\|$, where $\| \cdot \|$ denotes the length of a vector in E' . Let Z be the zero locus of s' ; s is only a partial section in the sense that it is not defined over Z . Thus to prove the proposition, we only have to show that the vector bundle E' has a section that vanishes over a finite number of points.

This is an easy consequence of the transversality theorem which states that given a submanifold Z in a manifold Y , every map $f : X \rightarrow Y$ becomes transversal to Z under a slight perturbation (Guillemin and Pollack [1, p. 68]). Furthermore, we may assume that a small perturbation of a section of E is again a section, as follows. Suppose f is a perturbation of s and f is transversal to the zero section. Then $g = \pi \circ f$ is a perturbation of $\pi \circ s$, which is the identity. Thus, for a sufficiently small perturbation, g will be close to the identity and so must be a diffeomorphism. For such an f , define $s'(x) = f(g^{-1}(x))$. Then $\pi \circ s' = 1$ and s' is transversal to the zero section s_0 , i.e., $S = s'(M)$ intersects $S_0 = s_0(M)$ transversally. Since

$$\dim S + \dim S_0 = \dim E',$$

$S \cap S_0$ consists of a discrete set of points. By the compactness of S , it must be a finite set of points. \square

REMARK 11.15. It follows from the rudiments of obstruction theory that this proposition is true even if the structure group of the sphere bundle cannot be reduced to an orthogonal group. For a beautiful account of obstruction theory, see Steenrod [1, Part III].

Suppose s is a section over a punctured neighborhood of a point x in M . Choose this neighborhood sufficiently small so that it is diffeomorphic to a punctured disc in \mathbb{R}^k and E is trivial over it. Let D_r be the open neighborhood of x corresponding to the ball of radius r in \mathbb{R}^k under the diffeomorphism above. As an open subset of the oriented manifold M , D_r is also oriented. Choose the orientation on the sphere S^{k-1} in such a way that the isomorphism $E|_{D_r} \cong D_r \times S^{k-1}$ is orientation-preserving, where $D_r \times S^{k-1}$ is given the product orientation. (If A and B are two oriented manifolds with orientation forms ω_A and ω_B , then the product orientation on $A \times B$ is given by $(p_1^* \omega_A) \wedge (p_2^* \omega_B)$, where p_1 and p_2 are the projections of $A \times B$ onto A and B respectively.) The local degree of the section s at x is defined to be the degree of the composite map

$$\partial \bar{D}_r \xrightarrow{\rho} E|_{D_r} = \bar{D}_r \times S^{k-1} \xrightarrow{\rho} S^{k-1}$$

where ρ is the projection and \bar{D}_r is the closure of D_r .

Theorem 11.16. *Let $\pi : E \rightarrow M$ be an oriented $(k-1)$ -sphere bundle over a compact oriented manifold of dimension k . If E has a section over $M - \{x_1, \dots, x_q\}$, then the Euler number of E is the sum of the local degrees of s at x_1, \dots, x_q .*

PROOF. Let M_r be M minus the balls of radius r around the points x_1, \dots, x_q . (By the radius, we mean the radius in \mathbb{R}^n under some fixed diffeomorphisms of the neighborhoods of the singular points x_1, \dots, x_q as above.) The Euler number of E is

$$\begin{aligned}
 (11.16.1) \quad \int_M e &= \lim_{r \rightarrow 0} \int_{M_r} e = \lim_{r \rightarrow 0} \int_{M_r} s^* \pi^* e && \text{since } s \text{ is a global section} \\
 & && \text{over } M_r, \\
 &= - \lim_{r \rightarrow 0} \int_{M_r} s^* d\psi && \text{because } \pi^* e = -d\psi \\
 &= - \lim_{r \rightarrow 0} \int_{\partial M_r} s^* \psi && \text{by Stokes' theorem.}
 \end{aligned}$$

For each i , choose an open ball D_r around the singularity x_i as before. (To keep the notation simple, we write D_r , rather than $D_{r,i}$.) Let σ the generator of S^{k-1} . Then $\rho^* \sigma$ restricts to the generator on each fiber of $E|_{D_r}$. So $\rho^* \sigma$ and the angular form ψ define the same cohomology class in $H^*(E|_{D_r})$, i.e.,

$$\psi - \rho^* \sigma = d\tau$$

for some $(k-2)$ -form τ on $E|_{D_r}$. By shrinking r slightly, we may assume that τ is defined over a neighborhood of the closed ball \bar{D}_r . Then

$$s^* \psi - s^* \rho^* \sigma = s^* d\tau$$

and

$$\int_{\partial \bar{D}_r} s^* \psi - \int_{\partial \bar{D}_r} s^* \rho^* \sigma = \int_{\partial \bar{D}_r} ds^* \tau = 0 \quad \text{by Stokes' theorem.}$$

Therefore,

$$\int_{\partial \bar{D}_r} s^* \psi = \text{local degree of the section } s \text{ at } x_i.$$

Since $\partial \bar{D}_r$ has the opposite orientation as ∂M_r ,

$$- \lim_{r \rightarrow 0} \int_{\partial M_r} s^* \psi = \lim_{r \rightarrow 0} \sum_{x_i} \int_{\partial \bar{D}_r} s^* \psi = \sum_i (\text{local degree of } s \text{ at } x_i).$$

Together with (11.16.1), this gives

$$\int_M e = \sum_i (\text{local degree of } s \text{ at } x_i).$$

□

This theorem can also be phrased in terms of vector bundles. Let $\pi : E \rightarrow M$ be an oriented rank k vector bundle over a manifold of dimension k and s a section of E with a finite number of zeros. The *multiplicity* of a zero x of s is defined to be the local degree of x as a singularity of the section $s/\|s\|$ of the unit sphere bundle of E relative to some Riemannian structure on E . (This definition of the index is independent of the Riemannian structure because the local degree is a homotopy invariant.) Since the Euler class $e(E)$ of E is a k -form on M , it is Poincaré dual to nP , where $n = \int_M e(E)$ and P is a point on M . Thus we have the following.

Theorem 11.17. *Let $\pi : E \rightarrow M$ be an oriented rank k vector bundle over a compact oriented manifold of dimension k . Let s be a section of E with a finite number of zeros. The Euler class of E is Poincaré dual to the zeros of s , counted with the appropriate multiplicities.*

EXAMPLE 11.18 (The Euler class of the unit tangent bundle to S^2). Let $S(T_{S^2})$ be the unit tangent bundle to S^2 . It is a circle bundle over S^2 :

$$\begin{array}{ccc} S^1 & \rightarrow & S(T_{S^2}) \\ & & \downarrow \\ & & S^2 \end{array}$$

Fix a unit tangent vector v at the north pole. We can define a smooth vector field on $S^2 - \{\text{south pole}\}$ by parallel translating v along the great circles from the north pole to the south pole (see Figure 11.1). (Parallel translation along a great circle on S^2 is prescribed by the following two conditions:

- (a) the tangent field to the great circle is parallel;
- (b) the angles are preserved under parallel translation.)

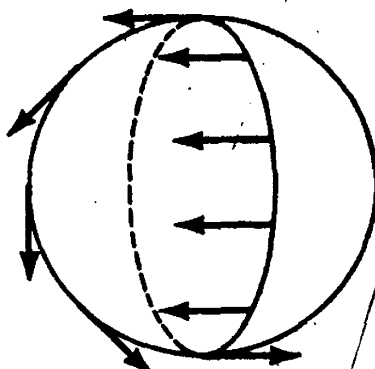

Figure 11.1

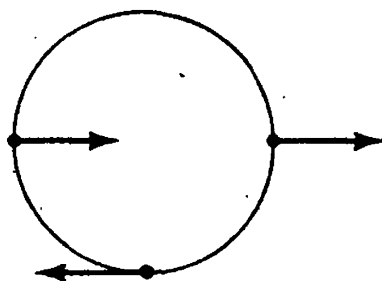

Figure 11.2

This gives a section s of $S(T_{S^2})$ over $S^2 - \{\text{south pole}\}$. On a small circle around the south pole, the vector field looks like Figure 11.2, i.e., as we go around the circle 90° , the vectors rotate through 180° ; therefore, the local degree of s at the south pole is 2. By Theorem 11.16, the Euler class of the unit tangent bundle to S^2 is 2.

Exercise 11.19. Show that the Euler class of an oriented sphere bundle with even-dimensional fibers is zero, at least when the sphere bundle comes from a vector bundle.

Since the Euler class is the obstruction to finding a closed global angular form on an oriented sphere bundle, by the Leray-Hirsch theorem we have the following corollary of Exercise 11.14.

Proposition 11.20. *If $\pi : E \rightarrow M$ is an orientable S^{2n} -bundle, then*

$$H^*(E) = H^*(M) \otimes H^*(S^{2n}).$$

Exercise 11.21. Compute the Euler class of the unit tangent bundle of the sphere S^k by finding a vector field on S^k and computing its local degrees.

Euler Characteristic and the Hopf Index Theorem

In this section we show that the Euler number $\int_M e(T_M)$ is the same as the Euler characteristic $\chi(M) = \sum (-1)^q \dim H^q(M)$ and deduce as a corollary the Hopf index theorem. The manifold M is assumed to be compact and oriented.

Let $\{\omega_i\}$ be a basis of the vector space $H^*(M)$, $\{\tau_j\}$ be the dual basis under Poincaré duality, i.e., $\int_M \omega_i \wedge \tau_j = \delta_{ij}$, and let π and ρ be the two projections of $M \times M$ to M :

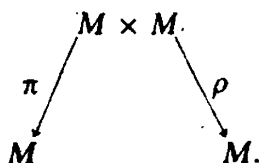

By the Künneth formula, $H^*(M \times M) = H^*(M) \otimes H^*(M)$ with $\{\pi^*\omega_i \wedge \rho^*\tau_j\}$ as an additive basis. So the Poincaré dual η_Δ of the diagonal Δ in $M \times M$ is some linear combination $\eta_\Delta = \sum c_{ij} \pi^*\omega_i \wedge \rho^*\tau_j$.

Lemma 11.22. $\eta_\Delta = \sum (-1)^{\deg \omega_i} \pi^*\omega_i \wedge \rho^*\tau_i$.

PROOF. We compute $\int_\Delta \pi^*\tau_k \wedge \rho^*\omega_l$ in two ways. On the one hand, we can pull this integral back to M via the diagonal map $i : M \rightarrow \Delta \subset M \times M$:

$$\int_\Delta \pi^*\tau_k \wedge \rho^*\omega_l = \int_M i^*\pi^*\tau_k \wedge i^*\rho^*\omega_l = \int_M \tau_k \wedge \omega_l = (-1)^{(\deg \tau_k)(\deg \omega_l)} \delta_{kl}.$$

On the other hand, by the definition of the Poincaré dual of a closed oriented submanifold (5.13),

$$\begin{aligned} \int_\Delta \pi^*\tau_k \wedge \rho^*\omega_l &= \int_{M \times M} \pi^*\tau_k \wedge \rho^*\omega_l \wedge \eta_\Delta \\ &= \sum_{i,j} c_{ij} \int_{M \times M} \pi^*\tau_k \wedge \rho^*\omega_l \wedge \pi^*\omega_i \wedge \rho^*\tau_j \\ &= \sum_{i,j} c_{ij} (-1)^{(\deg \tau_k + \deg \omega_l)(\deg \omega_i)} \int_{M \times M} \pi^*(\omega_i \wedge \tau_k) \rho^*(\omega_l \wedge \tau_j) \\ &= (-1)^{(\deg \tau_k + \deg \omega_l)\deg \omega_k} c_{kl}. \end{aligned}$$

Therefore

$$c_{kl} = \begin{cases} 0 & \text{if } k \neq l \\ (-1)^{\deg \omega_k} & \text{if } k = l. \end{cases}$$

□

Lemma 11.23. *The normal bundle N_Δ of the diagonal Δ in $M \times M$ is isomorphic to the tangent bundle T_Δ .*

PROOF. Since the diagonal map $i : M \times M$ sends M diffeomorphically onto Δ , $i^*T_\Delta = T_M$. It follows from the commutative diagram

$$\begin{array}{ccccccc} & & & & & & \\ & & & & & & \\ & & & & & & \\ & & & & & & \\ & & & & & & \\ (v, v) & \mapsto & (v, v) & & & & \\ \mathbf{0} & \rightarrow & T_\Delta & \xrightarrow{\gamma} & T_{M \times M}|_\Delta & \rightarrow & N_\Delta \rightarrow \mathbf{0} \\ & & \mathbb{R} & & \mathbb{R} & & \\ \mathbf{0} & \rightarrow & T_M & \rightarrow & T_M \oplus T_M & \rightarrow & T_M \rightarrow \mathbf{0} \\ & & v & \mapsto & (v, v) & & \end{array}$$

that $N_\Delta \cong T_M \simeq T_\Delta$.

□

Recall that the Poincaré dual of a closed oriented submanifold S is represented by the same form as the Thom class of a tubular neighborhood of S (see (6.23)). Thus

$$\begin{aligned} \int_{\Delta} \eta_{\Delta} &= \int_{\Delta} \Phi(N_{\Delta}) \quad \text{where } \Phi(N_{\Delta}) \text{ is the Thom class of the normal} \\ &\quad \text{bundle } N_{\Delta} \text{ regarded as a tubular neighborhood} \\ &\quad \text{of } \Delta \text{ in } M \times M \\ &= \int_{\Delta} e(N_{\Delta}) \quad \text{since the Thom class restricted to the zero} \\ &\quad \text{section of the bundle is the Euler class} \\ &= \int_{\Delta} e(T_{\Delta}) \\ &= \int_M e(T_M). \end{aligned}$$

So the self-intersection number of the diagonal Δ in $M \times M$ is the Euler number of M . (By Poincaré duality, $\int_{\Delta} \eta_{\Delta} = \int_{M \times M} \eta_{\Delta} \wedge \eta_{\Delta}$ is the self-intersection number of Δ in $M \times M$.)

Now the right-hand side of Lemma 11.22 evaluated on the diagonal Δ is

$$\begin{aligned} \int_{\Delta} \eta_{\Delta} &= \sum_i (-1)^{\deg \omega_i} \int_{\Delta} \pi^* \omega_i \wedge \rho^* \tau_i \\ &= \sum_i (-1)^{\deg \omega_i} \int_M i^* \pi^* \omega_i \wedge i^* \rho^* \tau_i \\ &= \sum_i (-1)^{\deg \omega_i} \int_M \omega_i \wedge \tau_i \\ &= \sum_i (-1)^{\deg \omega_i} \\ &= \sum_q (-1)^q \dim H^q(M) \\ &= \chi(M). \end{aligned}$$

Therefore,

Proposition 11.24. *The Euler number of a compact oriented manifold $\int_M e(T_M)$ is equal to its Euler characteristic $\chi(M) = \sum (-1)^q \dim H^q$.*

It is now a simple matter to derive the Hopf index theorem. Let V be a vector field with isolated zeros on M . The *index* of V at a zero u is defined to be the local degree at u of $V/\|V\|$ as a section of the unit tangent bundle

of M relative to some Riemannian metric on M . By Theorem 11.16 the sum of the indices of V is the Euler number of M . The equality of the Euler number and the Euler characteristic then yields the following.

Theorem 11.25 (Hopf Index Theorem). *The sum of the indices of a vector field on a compact oriented manifold M is the Euler characteristic of M .*

Exercise 11.26 (Lefschetz fixed-point formula). Let $f: M \rightarrow M$ be a smooth map of a compact oriented manifold into itself. Denote by $H^q(f)$ the induced map on the cohomology $H^q(M)$. The *Lefschetz number* of f is defined to be

$$L(f) = \sum_q (-1)^q \text{trace } H^q(f).$$

Let Γ be the graph of f in $M \times M$.

(a) Show that

$$\int_{\Delta} \eta_{\Gamma} = L(f).$$

(b) Show that if f has no fixed points, then $L(f)$ is zero.

(c) At a fixed point P of f the derivative $(Df)_P$ is an endomorphism of the tangent space $T_P M$. We define the *multiplicity* of the fixed point P to be

$$\sigma_P = \text{sgn } \det((Df)_P - I).$$

Show that if the graph Γ is transversal to the diagonal Δ in $M \times M$, then

$$L(f) = \sum_P \sigma_P,$$

where P ranges over the fixed points of f . (For an explanation of the meaning of the multiplicity σ_P , see Guillemin and Pollack [1, p. 121].)

§12 Thom Isomorphism and Poincaré Duality Revisited

In this section we study the Thom isomorphism and Poincaré duality from the tic-tac-toe point of view. The results obtained here are more general than those of Sections 5 and 6 in two ways:

- (a) M need not have a finite good cover,
- and
- (b) the orientability assumption on the vector bundle E has been dropped.

The Thom Isomorphism

Let $\pi : E \rightarrow M$ be a rank n vector bundle. E is not assumed to be orientable. We are interested in the cohomology of E with compact support in the vertical direction, $H_{cv}^*(E) = H^*\{\Omega_{cv}^*(E)\}$. Recall that

$$(a) H_c^*(\mathbb{R}^n) = \begin{cases} \mathbb{R} & \text{in dimension } n \\ 0 & \text{otherwise,} \end{cases}$$

$$(b) \text{ (Poincaré lemma) } H_{cv}^*(M \times \mathbb{R}^n) = H^{*-n}(M).$$

Let \mathcal{U} be a good cover of the base manifold M . We augment the double complex $C^*(\pi^{-1}\mathcal{U}, \Omega_{cv}^*)$ by adding a column consisting of the kernels of the first δ :

$$\begin{array}{ccccccc} 0 & \rightarrow & \Omega_{cv}^2(E) & \rightarrow & & & & & \\ 0 & \rightarrow & \Omega_{cv}^1(E) & \rightarrow & & & & & \\ 0 & \rightarrow & \Omega_{cv}^0(E) & \rightarrow & & & & & \end{array}$$

Using a partition of unity from the base, it can be shown that all the rows of this augmented double complex are exact. The proof is identical to that of the generalized Mayer-Vietoris sequence in (8.5) and will not be repeated here. From the exactness of the rows of the augmented complex, it follows as in (8.8) that the cohomology of the initial column is the total cohomology of the double complex, i.e.,

$$H_{cv}^*(E) \simeq H_D\{C^*(\pi^{-1}\mathcal{U}, \Omega_{cv}^*)\}.$$

On the other hand,

$$\begin{aligned} H_D^{p,q}\{C^*(\pi^{-1}\mathcal{U}, \Omega_{cv}^*)\} &= H_{cv}^q(\coprod \pi^{-1}U_{a_0 \dots a_p}) \\ &= \prod H_{cv}^q(\pi^{-1}U_{a_0 \dots a_p}) \\ &= C^p(\mathcal{U}, \mathcal{K}_{cv}^q), \end{aligned}$$

where \mathcal{K}_{cv}^q is the presheaf given by

$$\mathcal{K}_{cv}^q(U) = H_{cv}^q(\pi^{-1}U).$$

By the Poincaré lemma for compactly supported cohomology, if U is contractible, then

$$\mathcal{K}_{cv}^q(U) = \begin{cases} \mathbb{R} & \text{if } q = n \\ 0 & \text{otherwise.} \end{cases}$$

Therefore H_d and also $H_D^{p,q}H_d = H_D^p\{C^*(\mathcal{U}, \mathcal{K}_{cv}^q)\} = H^p(\mathcal{U}, \mathcal{K}_{cv}^q)$ have entries only in the n th row.

Proposition 12.1. *Given any double complex K , if $H_d H_d(K)$ has entries only in one row, then $H_d H_d$ is isomorphic to H_D .*

This proposition will be substantially generalized in Section 14, for it is simply an example of a degenerate spectral sequence. Its proof is a technical exercise which we defer to the end of this section. Combined with the preceding discussion, it gives

$$H_{cv}^*(E) = H_D^* = \bigoplus_{p+q=*} H^p(U, \mathcal{H}_{cv}^q) = H^{*-n}(U, \mathcal{H}_{cv}^n).$$

This is the Thom isomorphism for a not necessarily orientable vector bundle.

Theorem 12.2 (Thom Isomorphism). For $\pi : E \rightarrow M$ any vector bundle of rank n over M and \mathcal{U} a good cover of M ,

$$H_{cv}^*(E) \simeq H^{*-n}(U, \mathcal{H}_{cv}^n),$$

where \mathcal{H}_{cv}^n is the presheaf $\mathcal{H}_{cv}^n(U) = H_{cv}^n(\pi^{-1}U)$.

We now deduce the orientable version of the Thom isomorphism from this. So suppose $\pi : E \rightarrow M$ is an orientable vector bundle of rank n over M . This means there exist forms σ_α on the sphere bundles $S(E)|_{U_\alpha}$ which restrict to a generator on each fiber and such that on overlaps $U_\alpha \cap U_\beta$ their cohomology classes agree: $[\sigma_\alpha] = [\sigma_\beta]$. Now choose a Riemannian metric on E so that the "radius" r is well-defined on each fiber and any function of the radius r is a global function on E . Let $\rho(r)$ be the function shown in Figure 12.1. Then $(d\rho)\sigma_\alpha$ is a form on $E|_{U_\alpha}$, where we regard σ_α as a form on the complement of the zero section. Furthermore, $[(d\rho)\sigma_\alpha] \in H_{cv}^n(E|_{U_\alpha})$ restricts to a generator of the compactly supported cohomology of the fiber and $[(d\rho)\sigma_\alpha] = [(d\rho)\sigma_\beta]$ on $U_\alpha \cap U_\beta$. Since the fiber has no cohomology in dimensions less than n , $\sigma_\alpha^{0..n} = \{\sigma_\alpha\}$ can be extended to a D -cocycle. This D -cocycle corresponds to a global closed form Φ on E , the Thom class of E , which restricts to a generator on each fiber. Now $\mathcal{H}_{cv}^n(U)$ is generated by $\Phi|_U$ and for $V \subset U$ the restriction map from $\mathcal{H}_{cv}^n(U)$ to $\mathcal{H}_{cv}^n(V)$ sends $\Phi|_U$

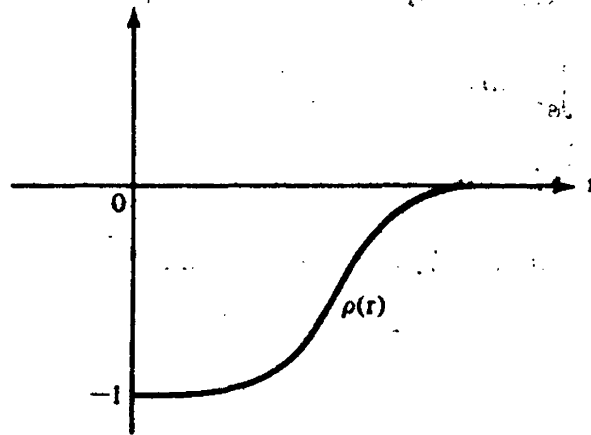

Figure 12.1

to $\Phi|_U$. Hence, via the map which sends $\Phi|_U$, for every open set U , to the generator 1 of the trivial presheaf \mathbb{R} , the presheaf \mathcal{H}_{cv}^n is isomorphic to \mathbb{R} . The Thom isomorphism theorem then assumes the form

$$(12.2.1) \quad H_{cv}^*(E) \simeq H^{*-n}(U, \mathcal{H}_{cv}^n) = H^{*-n}(U, \mathbb{R}) = H^{*-n}(M),$$

for an orientable rank n vector bundle E . This agrees with Proposition 6.17. It holds in particular when M is simply connected, since by (11.5), every vector bundle over a simply connected manifold is orientable.

From the explicit formula (11.11) for the global angular form on an oriented sphere bundle, we can derive a formula for the Thom class of an oriented vector bundle. Let $f : E^0 \rightarrow S(E)$ be a deformation retraction of the complement of the zero section in E onto the unit sphere bundle. If ψ_S is the global angular form on $S(E)$, then $\psi = f^*\psi_S \in H^{n-1}(E^0)$ is the global angular form on E^0 . It has the property that

$$d\psi = -\pi^*e,$$

where e represents the Euler class of the bundle E .

Proposition 12.3. *The cohomology class of*

$$\Phi = d(\rho(r) \cdot \psi) \in \Omega_{cv}^n(E)$$

is the Thom class of the oriented vector bundle E .

PROOF. Note that

$$(12.3.1) \quad \Phi = d\rho(r) \cdot \psi - \rho(r)\pi^*e.$$

For the same reasons as in the discussion following (6.40), Φ is a closed global form on E with compact support in the vertical direction. Its restriction to the fiber at p is $d\rho(r) \cdot i_p^*\psi$, where $i_p : E_p \rightarrow E$ is the inclusion and $i_p^*\psi$ gives a generator of $H^{n-1}(\mathbb{R}^n - \{0\}) = H^{n-1}(S^{n-1})$. Since

$$\int_{\mathbb{R}^n} d\rho(r) \cdot i_p^*\psi = \int_{\mathbb{R}^1} d\rho(r) \int_{S^{n-1}} i_p^*\psi = 1,$$

by (6.18), Φ is the Thom class of E . □

If s is the zero section of E , then $s^*d\rho = 0$ and $s^*\rho = -1$. By (12.3.1),

$$s^*\Phi = -(s^*\rho)s^*\pi^*e = e.$$

Thus,

Proposition 12.4. *The pullback of the Thom class of an oriented rank n vector bundle via the zero section to the base manifold is the Euler class.*

REMARK 12.4.1. From the formula for the Thom class (12.3), it is clear that by making the support of $\rho(r)$ sufficiently close to 0, the Thom class Φ can be made to have support arbitrarily close to the zero section of the vector bundle.

REMARK 12.4.2. In fact, in Proposition 12.4 any section will pull the Thom class back to the Euler class. Let s be a section of the oriented vector bundle E and $s^* : H_{cv}^*(E) \rightarrow H^*(M)$ the induced map in cohomology. Note that s^* can be written as the composition of the natural maps $i : H_{cv}^*(E) \rightarrow H^*(E)$ and $\bar{s}^* : H^*(E) \rightarrow H^*(M)$. As a map from M into E , the section s is homotopic to the zero section s_0 . By the homotopy axiom for de Rham cohomology (Cor. 4.1.2), $\bar{s}^* = \bar{s}_0^*$. Hence, $s^* = s_0^*$.

Using the description of the Euler class as the pullback of the Thom class, it is easy to prove the Whitney product formula.

Theorem 12.5 (Whitney Product Formula for the Euler Class). *If E and F are two oriented vector bundles, then $e(E \oplus F) = e(E)e(F)$.*

PROOF. By Proposition 6.19, the Thom class of $E \oplus F$ is

$$\Phi(E \oplus F) = \pi_1^* \Phi(E) \wedge \pi_2^* \Phi(F)$$

where π_1 and π_2 are the projections of $E \oplus F$ onto E and F respectively. Let s be the zero section of $E \oplus F$. Then $\pi_1 \circ s$ and $\pi_2 \circ s$ are the zero sections of E and F . By Proposition 12.4,

$$e(E \oplus F) = s^* \Phi(E \oplus F) = s^* \pi_1^* \Phi(E) \wedge s^* \pi_2^* \Phi(F) = e(E)e(F).$$

□

Exercise 12.6. Let $\pi : E \rightarrow M$ be an oriented vector bundle.

- (a) Show that $\pi^* e = \Phi$ as cohomology classes in $H^*(E)$, but not in $H_{cv}^*(E)$.
- (b) Prove that $\Phi \wedge \Phi = \Phi \wedge \pi^* e$ in $H_{cv}^*(E)$.

Euler Class and the Zero Locus of a Section

Let $\pi : E \rightarrow M$ be a vector bundle and S_0 the image of the zero section in E . A section s of E is transversal if its image $S = s(M)$ intersects S_0 transversally. The purpose of this section is to derive an interpretation of the Euler class of an oriented vector bundle as the Poincaré dual of the zero locus of a transversal section. This is an analogue of Theorem 11.17, which is more special in that $\text{rank } E = \dim M$, but more general in that the section is not assumed to be transversal.

Proposition 12.7. *Let $\pi : E \rightarrow M$ be any vector bundle and Z the zero locus of a transversal section. Then Z is a submanifold of M and its normal bundle in M is $N_{Z/M} \simeq E|_Z$.*

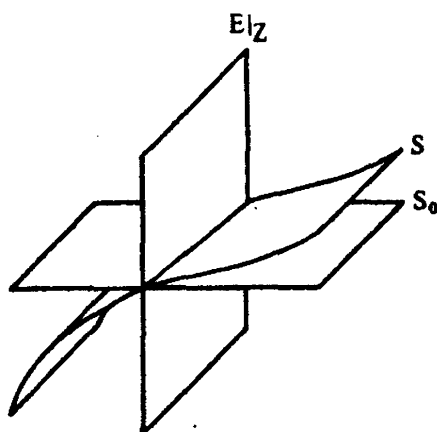

Figure 12.2

PROOF. Write $S = s(M)$ for the image of the section s (see Figure 12.2). Because S intersects S_0 transversally, $S \cap S_0$ is a submanifold of S by the transversality theorem (Guillemin and Pollack [1, p. 28]). Under the diffeomorphism $s : M \rightarrow S$, Z is mapped homeomorphically to $S \cap S_0$. So Z can be made into a submanifold of M .

To compute the normal bundle of Z , we first note that because E is locally trivial, its tangent bundle on S_0 has the following canonical decomposition

$$T_E|_{S_0} = E|_{S_0} \oplus T_{S_0}.$$

By the transversality of $S \cap S_0$,

$$T_S + T_{S_0} = T_E = E \oplus T_{S_0} \text{ on } S \cap S_0.$$

Hence the projection $T_S \rightarrow E$ over $S \cap S_0$ is surjective with kernel $T_S \cap T_{S_0}$. Again by the transversality of $S \cap S_0$, $T_S \cap T_{S_0} = T_{S \cap S_0}$. So we have an exact sequence over $Z \simeq S \cap S_0$:

$$0 \rightarrow T_Z \rightarrow T_S|_Z \rightarrow E|_Z \rightarrow 0.$$

Hence $N_{Z/M} \simeq E|_Z$. □

In the proposition above, if E and M are both oriented, then the zero locus Z of a transversal section is naturally an *oriented* manifold, oriented in such a way that

$$E|_Z \oplus T_Z = T_M|_Z$$

has the direct sum orientation.

Proposition 12.8. *Let $\pi : E \rightarrow M$ be an oriented vector bundle over an oriented manifold M . Then the Euler class $e(E)$ is Poincaré dual to the zero locus of a transversal section.*

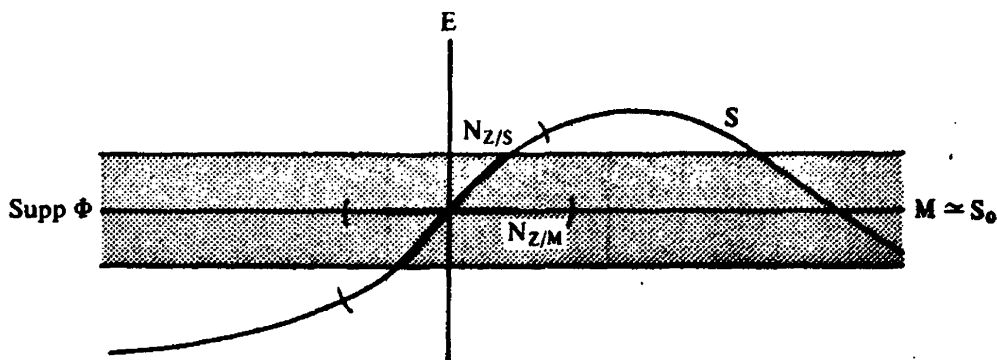

Figure 12.3

PROOF. We will identify M with the image S_0 of the zero section. If S is the image in E of the transversal section $s : M \rightarrow E$, then the zero locus of s is $Z = S \cap S_0$. Z is a closed oriented submanifold of M and by Proposition 12.7, its normal bundle in M is $N_{Z/M} = E|_Z$. Since S is diffeomorphic to M , the normal bundle $N_{Z/S}$ of Z in S is also $E|_Z$. The normal bundles $N_{Z/M}$ and $N_{Z/S}$ will be identified with the tubular neighborhoods of Z in M and in S respectively, as in Figure 12.3.

Choose the Thom class Φ of E to have support so close to the zero section (Remark 12.4.1) that Φ restricted to the tubular neighborhood $N_{Z/S}$ in S has compact support in the vertical direction. In Figure 12.3 the support of Φ is in the shaded region. We will now show that $s^*\Phi$ is the Thom class of the tubular neighborhood $N_{Z/M}$ in M .

Let $E_z, S_z,$ and M_z be the fibers of $E|_Z \simeq N_{Z/S} \simeq N_{Z/M}$ respectively above the point z in Z . Because Φ has compact support in $S_z,$ $s^*\Phi$ has compact support in $M_z.$ Furthermore,

$$\begin{aligned} \int_{M_z} s^*\Phi &= \int_{S_z} \Phi && \text{by the invariance of the integral under the} \\ &&& \text{orientation-preserving diffeomorphism } s : M_z \rightarrow S_z \\ &= \int_{E_z} \Phi && \text{because } E_z \text{ is homotopic to } S_z \text{ modulo the region} \\ &&& \text{in } E \text{ where } \Phi \text{ is zero} \\ &= 1 && \text{by the definition of the Thom class.} \end{aligned}$$

So $s^*\Phi$ is the Thom class of $N_{Z/M}$. By Proposition 12.4, $s^*\Phi = e(E)$. Since by (6.24) the Thom class of $N_{Z/M}$ is Poincaré dual to Z in M , the Euler class $e(E)$ is Poincaré dual to Z in M . □

A Tic-Tac-Toe Lemma

In this section we will prove the technical lemma (Proposition 12.1) that if H_s, H_t of a double complex K has entries in only one row, then H_s, H_t is isomorphic to the total cohomology $H_D(K)$. With this tic-tac-toe lemma we will re-examine the Mayer-Vietoris principle of Section 8.

PROOF OF PROPOSITION 12.1.

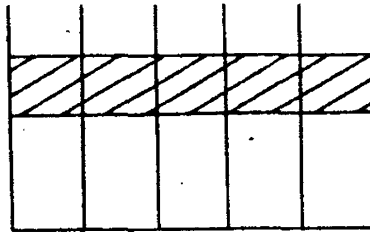

We first define a map $h: H_s H_d \rightarrow H_D$. Recall that $D = D' + D'' = \delta + (-1)^p d$. An element $[\phi]$ in $H_s^{p,q} H_d$ may be represented by a D -cochain ϕ of degree (p, q) such that

$$D''\phi = 0$$

$$\delta\phi = -D''\phi_1 \text{ for some } \phi_1.$$

This is summarized by the diagram

$$\begin{array}{ccc} & 0 & \\ D'' \uparrow & & \\ \phi \xrightarrow{\delta} & \delta\phi + D''\phi_1 = 0 & \\ & \uparrow D'' & \\ & \phi_1 & \end{array}$$

Since $H_s^{p+2, q-1} H_d = 0$, $\delta\phi_1 = -D''\phi_2$ for some ϕ_2 . Continuing in this manner, we see that ϕ can be extended downward to a D -cocycle $\phi + \phi_1 + \cdots + \phi_n$. The map h is defined by sending $[\phi]$ to $[\phi + \phi_1 + \cdots + \phi_n]$.

Next we define the inverse map $g: H_D \rightarrow H_s H_d$. Let ω be a cocycle in H_D . As the image of ω we cannot simply take the component of ω in the nonzero row because d of it may not be zero. Suppose $\omega = a + b + c + \cdots$ as shown.

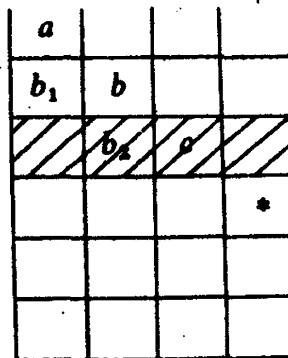

We will move ω in its D -cohomology class so that it has nothing above the nonzero row. Since $da = 0$ and $\delta a = -D''b$, a represents a cocycle in $H_s H_d$. But $H_s H_d = 0$ at the position of a , so a is 0 in $H_s H_d$; this implies that

$a = D''a_1$ for some a_1 . Then $\omega - Da_1$ has no components in the first column. Thus we may assume $\omega = b + c + \dots$. Again b is 0 in $H_\delta H_\delta$, so that $b = \delta b_1 + D''b_2$, where $D''b_1 = 0$. Then $\omega - D(b_1 + b_2) = (c - \delta b_1) + \dots$ starts at the nonzero row.

$$\begin{array}{c}
 0 \\
 \uparrow \\
 b_1 \rightarrow b \\
 \uparrow \\
 b_2 \rightarrow c
 \end{array}$$

Thus given $[\omega] \in H_D$, we may pick ω to have no components above the nonzero row of $H_\delta H_\delta$, say $\omega = c + \dots$. Then $dc = 0$ and the map $g : H_D \rightarrow H_\delta H_\delta$ is defined by sending $[\omega]$ to $[c]$.

Provided they are well-defined, h and g are clearly inverse to each other.

Exercise 12.9. Show that h and g are well-defined. □

Using Proposition 12.1 we can give more succinct proofs of the main results of Section 8. Let $\mathcal{U} = \{U_\alpha\}$ be an open cover of the manifold M and $C^p(\mathcal{U}, \Omega^q) = \prod \Omega^q(U_{\alpha_0 \dots \alpha_p})$. By the exactness of the Mayer-Vietoris sequence, H_δ of the Čech-de Rham complex $C^*(\mathcal{U}, \Omega^*)$ is

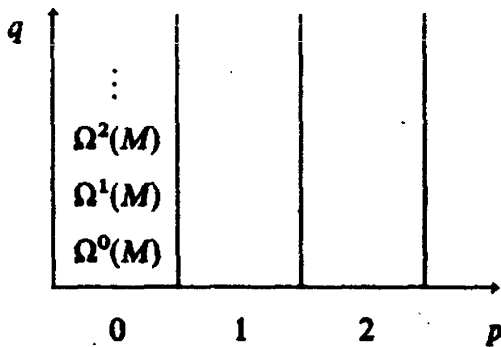

so that $H_\delta H_\delta$ is

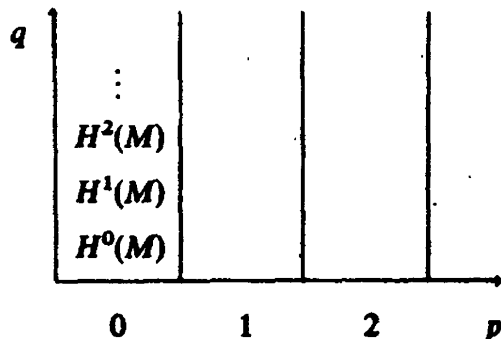

Since $H_d H_s$ has only one nonzero column, we conclude from Proposition 12.1 that

$$H_D^* \{C^*(\mathcal{U}, \Omega^*)\} \simeq H_{DR}^*(M)$$

for any cover \mathcal{U} . This is the generalized Mayer-Vietoris principle (Proposition 8.8).

Now if \mathcal{U} is a good cover, H_d of the Čech-de Rham complex is

$$\begin{array}{c} q \\ \uparrow \\ \begin{array}{|c|c|c|} \hline C^0(\mathcal{U}, \mathbb{R}) & C^1(\mathcal{U}, \mathbb{R}) & C^2(\mathcal{U}, \mathbb{R}) \\ \hline \end{array} \\ \downarrow \\ \begin{array}{cccc} 0 & 1 & 2 & p \end{array} \end{array}$$

and $H_s H_d$ is

$$\begin{array}{c} q \\ \uparrow \\ \begin{array}{|c|c|c|} \hline H^0(\mathcal{U}, \mathbb{R}) & H^1(\mathcal{U}, \mathbb{R}) & H^2(\mathcal{U}, \mathbb{R}) \\ \hline \end{array} \\ \downarrow \\ \begin{array}{cccc} & & & p \end{array} \end{array}$$

Again because $H_s H_d$ has only one nonzero row,

$$H_D^* \{C^*(\mathcal{U}, \Omega^*)\} \simeq H^*(\mathcal{U}, \mathbb{R}).$$

This gives the isomorphism between de Rham cohomology and the Čech cohomology of a good cover with coefficients in the constant presheaf \mathbb{R} .

Exercise 12.10. Let CP^n have homogeneous coordinates z_0, \dots, z_n . Define $U_i = \{z_i \neq 0\}$. Then $\mathcal{U} = \{U_0, \dots, U_n\}$ is an open cover of CP^n , although not a good cover. Compute $H^*(CP^n)$ from the double complex $C^*(\mathcal{U}, \Omega^*)$. Find elements in $C^*(\mathcal{U}, \Omega^*)$ which represent the generators of $H^*(CP^n)$.

Exercise 12.11. Apply the Thom isomorphism (12.2) to compute the cohomology with compact support of the open Möbius strip (cf. Exercise 4.8).

Poincaré Duality

In the same spirit as above, we now give a version of Poincaré duality, in terms of the Čech-de Rham complex, for a not necessarily orientable manifold. Let M be a manifold of dimension n and $\mathcal{U} = \{U_\alpha\}$ any open cover of M . Define the coboundary operator

$$\delta : \bigoplus \Omega_c^*(U_{\alpha_0 \dots \alpha_p}) \rightarrow \bigoplus \Omega_c^*(U_{\alpha_0 \dots \alpha_{p-1}})$$

by the formula

$$(\delta\omega)_{\alpha_0 \dots \alpha_{p-1}} = \sum_{\alpha} \omega_{\alpha\alpha_0 \dots \alpha_{p-1}}$$

where on the right-hand side we mean the extension by zero of $\omega_{\alpha\alpha_0 \dots \alpha_{p-1}}$ to a form on $U_{\alpha_0 \dots \alpha_{p-1}}$. To ensure that each component of $\delta\omega$ has compact support, the groups here are direct sums rather than direct products, so that $\omega \in \bigoplus \Omega_c^*(U_{\alpha_0 \dots \alpha_p})$ by definition has only a finite number of nonzero components.

Proposition 12.12 (Generalized Mayer-Vietoris Sequence for Compact Supports). *The sequence*

$$\begin{array}{ccccccc} 0 \leftarrow \Omega_c^*(M) & \xleftarrow{\text{sum}} & \bigoplus \Omega_c^*(U_{\alpha_0}) & \leftarrow & \bigoplus \Omega_c^*(U_{\alpha_0 \alpha_1}) & \leftarrow & \dots \\ & & & & \leftarrow \dots \leftarrow & \bigoplus \Omega_c^*(U_{\alpha_0 \dots \alpha_p}) & \leftarrow \dots \end{array}$$

is exact.

PROOF. We first show $\delta^2 = 0$. Let ω be in $\bigoplus \Omega_c^*(U_{\alpha_0 \dots \alpha_p})$. Then

$$\begin{aligned} (\delta^2\omega)_{\alpha_0 \dots \alpha_{p-2}} &= \sum_{\alpha} (\delta\omega)_{\alpha\alpha_0 \dots \alpha_{p-2}} = \sum_{\alpha} \sum_{\beta} \omega_{\beta\alpha\alpha_0 \dots \alpha_{p-2}} \\ &= 0, \text{ since } \omega_{\alpha\beta \dots} = -\omega_{\beta\alpha \dots} \end{aligned}$$

Now suppose $\delta\omega = 0$. We will show that ω is a δ -coboundary. Let $\{\rho_\alpha\}$ be a partition of unity subordinate to the cover \mathcal{U} . Define

$$\tau_{\alpha_0 \dots \alpha_{p+1}} = \sum_{i=0}^{p+1} (-1)^i \rho_{\alpha_i} \omega_{\alpha_0 \dots \alpha_{i-1} \dots \alpha_{p+1}}$$

Note that $\tau_{\alpha_0 \dots \alpha_{p+1}}$ has compact support. Then

$$\begin{aligned} (\delta\tau)_{\alpha_0 \dots \alpha_p} &= \sum_{\alpha} \tau_{\alpha\alpha_0 \dots \alpha_p} \\ &= \sum_{\alpha} \left(\rho_{\alpha} \omega_{\alpha_0 \dots \alpha_p} + \sum_i (-1)^{i+1} \rho_{\alpha_i} \omega_{\alpha_0 \dots \alpha_{i-1} \dots \alpha_p} \right) \\ &= \omega_{\alpha_0 \dots \alpha_p} + \sum_i (-1)^{i+1} \rho_{\alpha_i} (\delta\omega)_{\alpha_0 \dots \alpha_{i-1} \dots \alpha_p} \\ &= \omega_{\alpha_0 \dots \alpha_p} \end{aligned}$$

□

Exercise 12.12.1. Show that the definition of τ in the proof above provides a homotopy operator for the compact Mayer-Vietoris sequence (12.12). More precisely, if ω is in $\bigoplus \Omega_c^*(U_{a_0 \dots a_p})$ and

$$(K\omega)_{a_0 \dots a_{p+1}} = \sum_{i=1}^{p+1} (-1)^i \rho_{a_i} \omega_{a_0 \dots \hat{a}_i \dots a_{p+1}},$$

then

$$\delta K + K\delta = 1.$$

Consider the double complex $C^p(\mathcal{U}, \Omega_c^q)$:

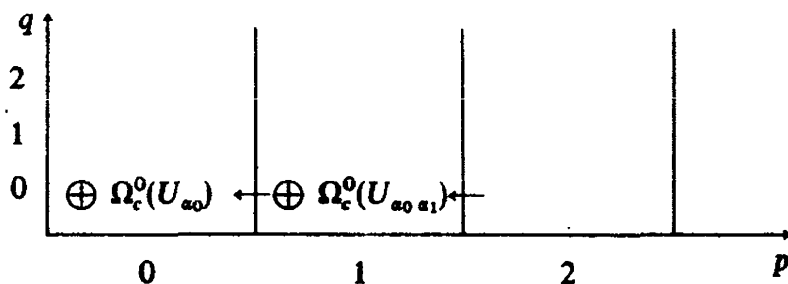

In this double complex the δ -operator goes in the wrong direction, so we define a new complex

$$K^{-p, q} = C^p(\mathcal{U}, \Omega_c^q).$$

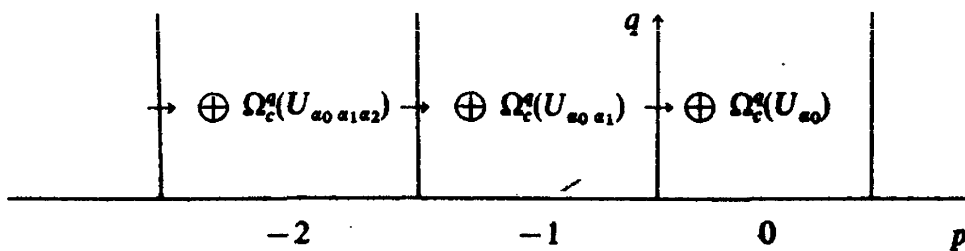

By the exactness of the rows, $H_p(K)$ is

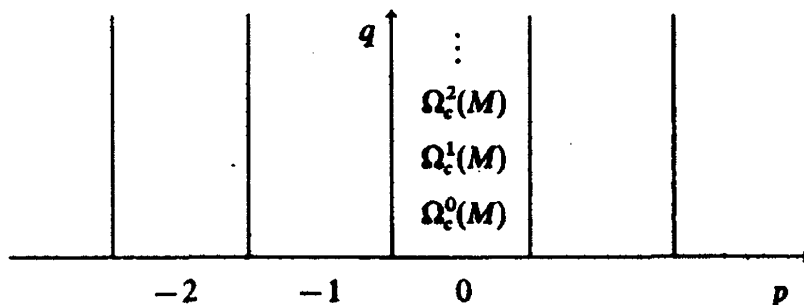

Since $H_d H_\delta$ has only one nonzero column, it follows from Proposition 12.1 that

$$(12.13) \quad H_D(K) = H_d H_\delta(K) = H_c(M).$$

On the other hand, if \mathcal{U} is a good cover, then $H_d(K)$ is

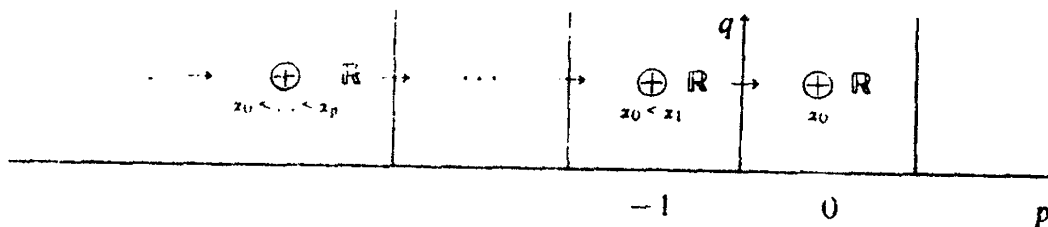

$$H_d^{p,q}(K) = C^p(\mathcal{U}, \mathcal{H}^q)$$

where \mathcal{H}^q is the covariant functor which associates to every open set U the compact cohomology $H_c^q(U)$ and to every inclusion i , the extension by zero, i_* ; moreover,

$$H_d^{p,q}(K) = 0 \quad \text{for } q \neq n.$$

Again by Proposition 12.1,

$$(12.14) \quad H_D^*(K) = H_\delta^{*-n} H_d = H_{n-*}(\mathcal{U}, \mathcal{H}_c^n).$$

Here $H_{n-*}(\mathcal{U}, \mathcal{H}_c^n)$ is the $(n - *)$ -th Čech homology of the cover \mathcal{U} with coefficients in the covariant functor \mathcal{H}_c^n (cf. Remark 10.3). Comparing (12.13) and (12.14) gives

Theorem 12.15 (Poincaré Duality). *Let M be a manifold of dimension n and \mathcal{U} any good cover of M . Here M is not assumed to be orientable. Then*

$$H_c^*(M) \simeq H_{n-*}(\mathcal{U}, \mathcal{H}_c^n),$$

where \mathcal{H}_c^n is the covariant functor $\mathcal{H}_c^n(U) = H_c^n(U)$.

Exercise 12.16. By applying Poincaré duality (12.15), compute the compact cohomology of the open Möbius strip (cf. Exercise 4.8).

§13 Monodromy

When Is a Locally Constant Presheaf Constant?

In the preceding section we saw that the compact vertical cohomology $H_{cv}^*(E)$ of a vector bundle E may be computed as the cohomology of the base with coefficients in a locally constant presheaf. When this locally constant presheaf is the constant presheaf \mathbb{R}^n , $H_{cv}^*(E)$ is expressible in terms of

the de Rham cohomology of the base manifold (Proposition 10.6). In this case the problem of computing $H_{cv}^*(E)$ is greatly simplified. It is therefore important to determine the conditions under which a locally constant presheaf is constant.

First we need to review some basic definitions from the theory of simplicial complexes (see, for instance, Croom [1]). Recall that if an n -simplex in an Euclidean space has vertices v_0, \dots, v_n , then its *barycenter* is the point $(v_0 + \dots + v_n)/(n + 1)$. For example, the barycenter of an edge is its midpoint and the barycenter of a triangle (a 2-simplex) is its center. The *first barycentric subdivision* of a simplex σ is the simplicial complex having all the barycenters of σ as vertices. By applying the barycentric subdivision to each simplex of a simplicial complex K , we obtain a new simplicial complex K' , called the *first barycentric subdivision* of K . The *support* of K , denoted $|K|$, is the underlying topological space of K , and the *k -skeleton of K* is the subcomplex consisting of all the simplices of dimension less than or equal to k . The complex K and its barycentric subdivision K' have the same support. The *star of a vertex v in K* , denoted $\text{st}(v)$, is the union of all the closed simplices in K having v as a vertex.

Next we introduce the notion of a presheaf on an open cover. Let X be a topological space and $\mathcal{U} = \{U_\alpha\}$ an open cover of X . The *presheaf \mathcal{F} on \mathcal{U}* is defined to be a functor \mathcal{F} on the subcategory of $\text{Open}(X)$ consisting of all finite intersections $U_{\alpha_0, \dots, \alpha_p}$ of open sets in \mathcal{U} . Equivalently, if $N(\mathcal{U})$ is the nerve of \mathcal{U} , the presheaf \mathcal{F} on \mathcal{U} is the assignment of an appropriate group to the barycenter of each simplex in $N(\mathcal{U})$; for example, the group attached to the barycenter of the 2-simplex representing $U \cap V \cap W$ is $\mathcal{F}(U \cap V \cap W)$. Each inclusion, say $U \cap V \rightarrow U$, becomes an arrow in the picture, $\mathcal{F}(U) \rightarrow \mathcal{F}(U \cap V)$, and the transitivity of the arrows says that Figure 13.1 is a commutative diagram.

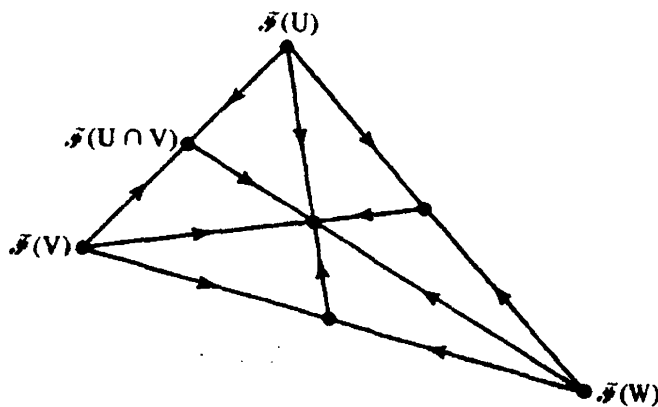

Figure 13.1

Two presheaves \mathcal{F} and \mathcal{G} are *isomorphic relative to an open cover* $\mathcal{U} = \{U_\alpha\}$ if for each $W = U_{\alpha_0 \dots \alpha_p}$ there is an isomorphism

$$h_W : \mathcal{F}(W) \rightarrow \mathcal{G}(W)$$

compatible with all arrows. In other words, there is a natural equivalence of functors $\mathcal{F} \rightarrow \mathcal{G}$ where \mathcal{F} and \mathcal{G} are regarded as functors on the subcategory of $\text{Open}(X)$ consisting of all finite intersections $U_{\alpha_0 \dots \alpha_p}$ of open sets in \mathcal{U} . The trivial presheaf and the constant presheaf on an open cover \mathcal{U} are defined as in Section 10. However, the definition of a locally constant presheaf on \mathcal{U} requires some care, since the notion of "local" does not make sense on a cover. We say that a presheaf \mathcal{F} is *locally constant* on \mathcal{U} if all the groups $\mathcal{F}(U_{\alpha_0 \dots \alpha_p})$ are isomorphic and all the arrows are isomorphisms. Note that a locally constant presheaf on a space X is locally constant on some open cover, and conversely.

Of course, if two presheaves \mathcal{F} and \mathcal{G} are isomorphic on an open cover \mathcal{U} , then the cohomology groups $H^*(\mathcal{U}, \mathcal{F})$ and $H^*(\mathcal{U}, \mathcal{G})$ are isomorphic.

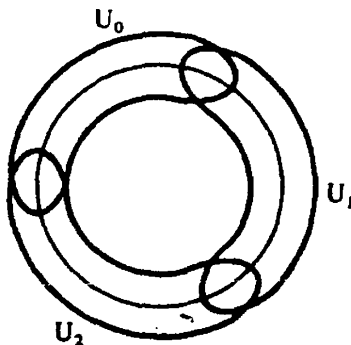

Figure 13.2

EXAMPLE 13.1 (A locally constant presheaf on \mathcal{U} which is not constant). Let $\mathcal{U} = \{U_0, U_1, U_2\}$ be a good cover of the circle S^1 (see Figure 13.2). Define a presheaf \mathcal{F} by

$$\mathcal{F}(U) = \mathbb{Z} \text{ for all open sets } U,$$

$$\rho_{01}^0 = \rho_{01}^1 = \rho_{12}^1 = \rho_{12}^2 = 1,$$

$$\rho_{02}^2 = -1, \rho_{02}^0 = 1.$$

\mathcal{F} is locally constant but not constant on \mathcal{U} because ρ_{02}^2 is not the identity.

Let \mathcal{F} be a locally constant presheaf with group G on an open cover $\mathcal{U} = \{U_\alpha\}$. Fix isomorphisms

$$\phi_\alpha : \mathcal{F}(U_\alpha) \xrightarrow{\sim} G.$$

If U_α and U_β intersect, then from the diagram

$$\begin{array}{ccc}
 & \phi_\alpha & \\
 \mathcal{F}(U_\alpha) & \xrightarrow{\sim} & G \\
 \rho_{\alpha\beta}^\alpha \downarrow & & \downarrow \\
 \mathcal{F}(U_\alpha \cap U_\beta) & & \\
 \rho_{\alpha\beta}^\beta \uparrow & & \phi_\beta \downarrow \\
 \mathcal{F}(U_\beta) & \xrightarrow{\sim} & G
 \end{array}$$

we obtain an automorphism of G , namely $\phi_\beta (\rho_{\alpha\beta}^\beta)^{-1} \rho_{\alpha\beta}^\alpha \phi_\alpha^{-1}$. Write $\rho_\beta^\alpha : \mathcal{F}(U_\alpha) \rightarrow \mathcal{F}(U_\beta)$ for the isomorphism $(\rho_{\alpha\beta}^\beta)^{-1} \circ \rho_{\alpha\beta}^\alpha$. Choose some vertex U_0 as the base point of the nerve $N(\mathcal{U})$. For $U_0 U_1 \dots U_r U_0$ a loop based at U_0 we get an automorphism of G by following along the edges

$$\begin{array}{ccc}
 \mathcal{F}(U_0) & \xrightarrow{\sim} & G \\
 \downarrow & & \downarrow \\
 \mathcal{F}(U_1) & \xrightarrow{\sim} & G \\
 \downarrow & & \downarrow \\
 \vdots & & \vdots \\
 \downarrow & & \downarrow \\
 \mathcal{F}(U_0) & \xrightarrow{\sim} & G
 \end{array}$$

This gives a map from $\{\text{loops at } U_0\}$ to $\text{Aut } G$. We claim that if a loop bounds a 2-chain, then the associated automorphism of G is the identity. Consider the example of the 2-simplex as shown in Figure 13.3.

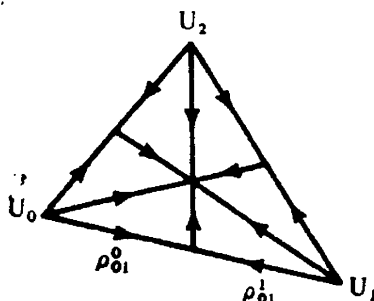

Figure 13.3

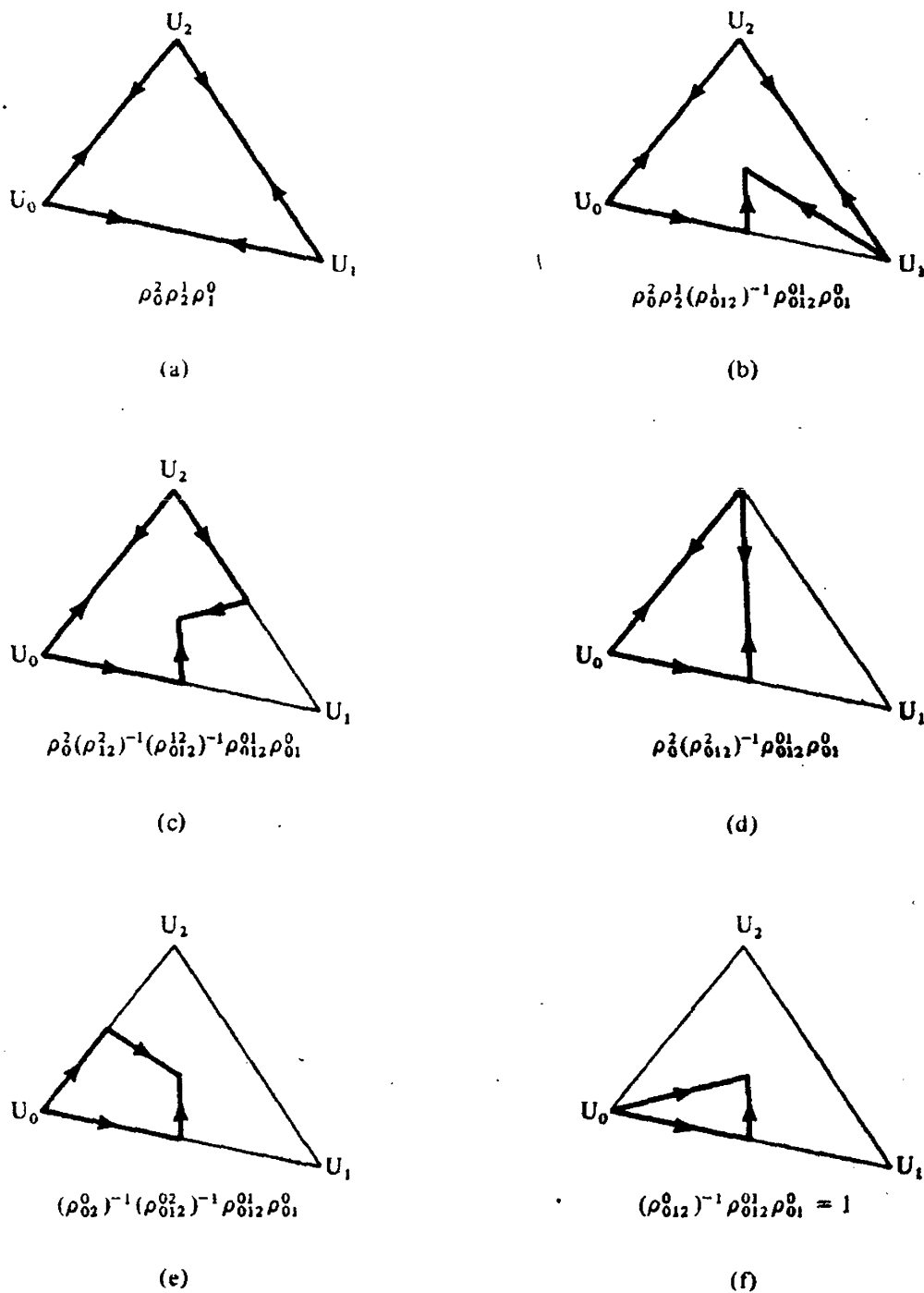

Figure 13.4

The associated automorphism of the loop $U_0 U_1 U_2$ is $\phi_0(\rho_0^2 \rho_2^1 \rho_1^0) \phi_0^{-1}$ so it is a matter of showing that $\rho_0^2 \rho_2^1 \rho_1^0$ is the identity. This is clear from the sequence of pictures in Figure 13.4, where we use heavy solid lines to indicate maps which, by the commutativity of the arrows, are all equal to $\rho_0^2 \rho_2^1 \rho_1^0$.

More generally, the same procedure shows that the map $\rho_0^\alpha \dots \rho_p^0$ around any bounding loop is the identity. Hence there is a homomorphism

$$\rho : \pi_1(N(\mathcal{U})) = \frac{\{\text{loops}\}}{\{\text{bounding loops}\}} \rightarrow \text{Aut } G,$$

called the *monodromy representation* of the presheaf \mathcal{F} . Here $\pi_1(N(\mathcal{U}))$ denotes the edge path group of the nerve $N(\mathcal{U})$ as a simplicial complex.

Theorem 13.2. *Let \mathcal{U} be an open cover on a connected topological space X and $N(\mathcal{U})$ its nerve. If $\pi_1(N(\mathcal{U})) = 0$, then every locally constant presheaf on \mathcal{U} is constant.*

PROOF. Suppose $\pi_1(N(\mathcal{U})) = 0$, i.e., every loop bounds some 2-chain. For each open set U_α , choose a path from U_0 to U_α , say $U_0 U_{\alpha_1} \dots U_{\alpha_r} U_\alpha$, and define $\psi_\alpha = \phi_0 (\rho_\alpha^{\alpha_r} \dots \rho_{\alpha_2}^{\alpha_1} \rho_{\alpha_1}^0)^{-1} : \mathcal{F}(U_\alpha) \rightarrow G$.

$$\begin{array}{ccc} & \phi_0 & \\ & \mathcal{F}(U_0) \xrightarrow{\sim} G & \\ & \downarrow & \\ & \mathcal{F}(U_\alpha) & \end{array}$$

ψ_α is well-defined independent of the chosen path, because as we have seen, around a bounding loop the map $\rho_0^\alpha \dots \rho_p^0$ is the identity.

Now carry out the barycentric subdivision of the nerve $N(\mathcal{U})$ to get a new simplicial complex K so that every open set $U_{\alpha_0 \dots \alpha_p}$ corresponds to a vertex of K . Clearly $\pi_1(N(\mathcal{U})) = \pi_1(K)$. By the same procedure as in the preceding paragraph we can define isomorphisms

$$\psi_{\alpha_0 \dots \alpha_p} : \mathcal{F}(U_{\alpha_0 \dots \alpha_p}) \rightarrow G$$

for all nonempty $U_{\alpha_0 \dots \alpha_p}$. The maps $\psi_{\alpha_0 \dots \alpha_p}$ give an isomorphism of the presheaf \mathcal{F} to the constant presheaf G on the cover \mathcal{U} . \square

REMARK 13.2.1. If the group G of a locally constant presheaf has no automorphisms except the identity, then there is no monodromy. In particular, every locally constant presheaf with group \mathbb{Z}_2 is constant.

REMARK 13.3. Recall that a *simplicial map* between two simplicial complexes K and L is a map f from the vertices of K to the vertices of L such that if v_0, \dots, v_n span a simplex in K , then $f(v_0), \dots, f(v_n)$ span a simplex in L . A simplicial map f from K to L induces a map $f : |K| \rightarrow |L|$ by linearity:

$$f\left(\sum \lambda_i v_i\right) = \sum \lambda_i f(v_i).$$

By abuse of language we refer to either of these maps as a simplicial map.

For the proof of the next theorem we assemble here some standard facts from the theory of simplicial complexes.

(a) The edge path group of a simplicial complex is the same as that of its 2-skeleton (Seifert and Threlfall [1, §44, p. 167]).

(b) The edge path group of a simplicial complex is the same as the topological fundamental group of its support (Seifert and Threlfall [1, §44, p. 165]).

(c) (The Simplicial Approximation Theorem). Let K and L be two simplicial complexes. Then every map $f: |K| \rightarrow |L|$ is homotopic to a simplicial map $g: |K^{(k)}| \rightarrow |L|$ for some integer k , where $K^{(k)}$ is the k -th barycentric subdivision of K (Croom [1, p. 49]).

Because of (b) we also refer to the edge path group of a simplicial complex as its fundamental group.

None of these facts are difficult to prove. They all depend on the following very intuitive principle from obstruction theory.

The Extension Principle. *A map from the union of all the faces of a cube into a contractible space can be extended to the entire cube.*

ASIDE. With a little homotopy theory the extension principle can be refined as follows. Let X be a topological space and I^k the unit k -dimensional cube. If $\pi_q(X) = 0$ for all $q \leq k - 1$, then any maps from the boundary of I^k into X can be extended to the entire cube I^k .

In section 5 we defined a good cover on a manifold to be an open cover $\{U_\alpha\}$ for which all finite intersections $U_{\alpha_0} \cap \cdots \cap U_{\alpha_p}$ are diffeomorphic to a Euclidean space. By a *good cover on a topological space* we shall mean an open cover for which all finite intersections are contractible.

REMARK. Thus, on a manifold there are two notions of a good cover. We do not know if they are equivalent in all dimensions. It appears to be a difficult question whether every contractible manifold of dimension n is diffeomorphic to \mathbb{R}^n , for an affirmative answer would imply the generalized Poincaré conjecture (which states that a compact manifold of dimension n having the homotopy type of the n -sphere S^n is homeomorphic to S^n). The generalized Poincaré conjecture is still open for $n = 3$ and $n = 4$, the case where $n > 4$ having been proved by Smale [1]. For a good cover on a manifold, we will always stick to the more restrictive hypothesis that the finite intersections are diffeomorphic to \mathbb{R}^n . This is because in order to prove Poincaré duality, whether by the Mayer–Vietoris argument of Section 5 or by the tic-tac-toe game of Section 12, we need the compact Poincaré lemma (Corollary 4.7), which is not always true for an open set with merely the homotopy type of \mathbb{R}^n .

Theorem 13.4. *Suppose the topological space X has a good cover \mathcal{U} . Then the fundamental group of X is isomorphic to the fundamental group $\pi_1(N(\mathcal{U}))$ of the nerve of the good cover.*

PROOF. Write $N_2(\mathcal{U})$ for the 2-skeleton of the nerve $N(\mathcal{U})$. Let U_i , U_{ij} , and U_{ijk} be the barycenters of the vertices, edges, and faces of $N_2(\mathcal{U})$ and let $N'_2(\mathcal{U})$ be its barycentric subdivision. As the first step in the proof of the theorem we will define a map f from $|N'_2(\mathcal{U})|$ to X . We will then show that this map induces an isomorphism of fundamental groups.

To this end choose a point p_i in each open set U_i in \mathcal{U} , a point p_{ij} in each nonempty pairwise intersection U_{ij} , and a point p_{ijk} in each nonempty triple intersection U_{ijk} . Also, fix a contraction c_i of U_i to p_i and a contraction c_{ij} of U_{ij} to p_{ij} . These contractions exist because \mathcal{U} is a good cover. By decree the map f sends U_i , U_{ij} , and U_{ijk} to p_i , p_{ij} , and p_{ijk} respectively.

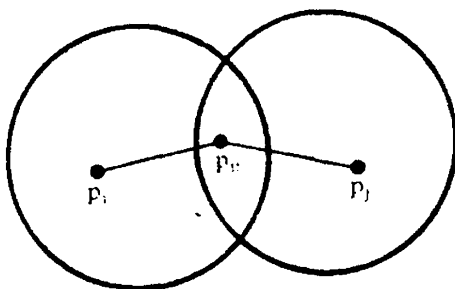

Figure 13.5

Next we define f on the edges of $|N'_2(\mathcal{U})|$. The contraction c_i takes p_{ij} to p_i and gives a well-defined path between p_i and p_{ij} . Similarly, the contraction c_j gives a well-defined path between p_j and p_{ij} (see Figure 13.5). Furthermore, for each point p_{ijk} the six contractions c_i , c_j , c_k , c_{ij} , c_{ik} , and c_{jk} produce six paths in X joining p_{ijk} to p_i , p_j , p_k , p_{ij} , p_{ik} , and p_{jk} respectively (see Figure 13.6).

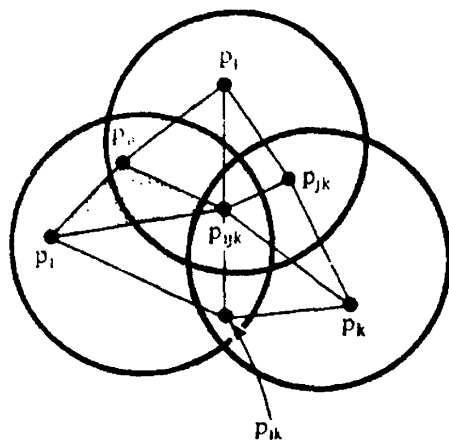

Figure 13.6

The map f shall send the edges of $|N'_2(\mathbb{U})|$ to the paths just defined; for example, the edge $U_i U_{ijk}$ is sent to the path joining p_i and p_{ijk} .

Finally we define f on the faces of $|N'_2(\mathbb{U})|$. Since each "triangle" $p_i p_{ij} p_{ijk}$ lies entirely inside the open set U_i (such a triangle may be *degenerate*; i.e., it may only be a point or a segment), the triangle may be "filled in" in a well-defined manner: to fill in the triangle $p_i p_{ij} p_{ijk}$, use the contraction c_i to contract the edge $p_{ij} p_{ijk}$ to p_i (see Figure 13.6). This "filled-in" triangle will be the image of the triangle $U_i U_j U_{ijk}$ under f . In summary, with the choice of the points p_i, p_{ij}, p_{ijk} and the contractions c_i, c_{ij} fixed, we have defined a map $f: |N'_2(\mathbb{U})| \rightarrow X$. We will now show that the induced map of fundamental groups, $f_*: \pi_1(|N'_2(\mathbb{U})|) \rightarrow \pi_1(X)$ is an isomorphism.

STEP 1 (Surjectivity of f_*). Take p_0 in U_0 to be the base point of X . Let $\gamma: S^1 \rightarrow X$ be a loop in X based at p_0 . We would like to deform γ to a map of the form $f_*(\bar{\gamma})$, where $\bar{\gamma}: S^1 \rightarrow |N_2(\mathbb{U})|$ is a loop in $|N_2(\mathbb{U})|$ based at U_0 .

Regard S^1 as the unit interval I with its endpoints identified. To define $\bar{\gamma}$, we first subdivide the unit interval into equal pieces, so that it becomes a simplicial complex K with vertices q_0, \dots, q_n (Figure 13.7).

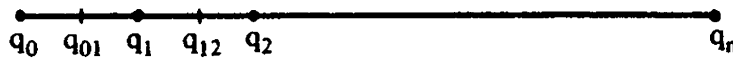

Figure 13.7.

By making the pieces sufficiently small, we can ensure that the star of q_i in the barycentric subdivision K' of K is mapped entirely into an open set $U_{\alpha(i)}$:

$$\gamma(\text{st}(q_i)) \subset U_{\alpha(i)}.$$

To simplify the notation, write j instead of $i + 1$, so that $q_i q_j$ is a 1-simplex in K . Let q_{ij} be the midpoint of $q_i q_j$. Define $\bar{\gamma}: S^1 \rightarrow |N_2(\mathbb{U})|$ by sending the segment $q_i q_j$ to the segment $U_{\alpha(i)} U_{\alpha(j)}$; it follows that $\bar{\gamma}(q_i) = U_{\alpha(i)}$ and $f_*(\bar{\gamma})(q_i) = p_{\alpha(i)}$.

Next define a map F on the sides of the square I^2 by (see Figure 13.8).

$$F|_{\text{bottom side}} = F(x, 0) = \gamma(x),$$

$$F|_{\text{top side}} = F(x, 1) = f_*(\bar{\gamma})(x),$$

and

$$F|_{\text{vertical sides}} = F(0, t) = F(1, t) = p_0.$$

The problem now is to extend $F: \partial I^2 \rightarrow X$ to the entire square. Subdivide the square by joining with vertical segments the vertices $(q_i, 0), (q_j, 0)$ on the bottom edge to the corresponding vertices on the top edge. Since $F(q_i, 0) = \gamma(q_i)$ and $F(q_i, 1) = f_*(\bar{\gamma})(q_i) = p_{\alpha(i)}$, they both lie in $U_{\alpha(i)}$. Since $U_{\alpha(i)}$ is contractible, by the extension principle F can be extended to the

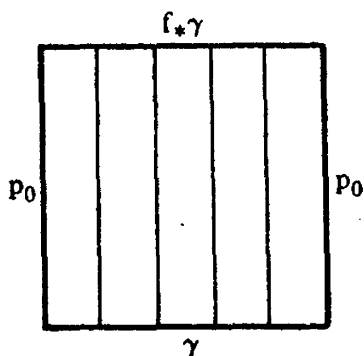

Figure 13.8

vertical segment $\{q_i\} \times I$. Similarly, F can be extended to the vertical segment $\{q_{i+1}\} \times I$. Thus in Figure 13.8, F is defined on the boundary of each rectangle and maps that boundary entirely into a contractible open set U_α . By the extension principle again, F can be extended over each rectangle. In this way F is extended to the entire square I^2 .

STEP 2 (Injectivity of f_*). Suppose $\gamma: I \rightarrow |N_2(\mathcal{U})|$ is a loop such that $f_*(\gamma)$ is null-homotopic in X . This means there is a map H from the square I^2 to X as in Figure 13.9.

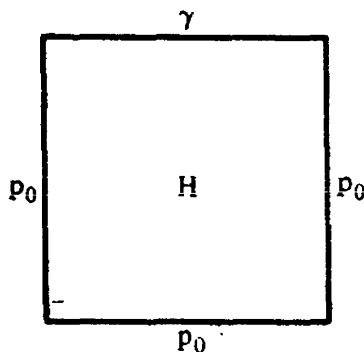

Figure 13.9

By the simplicial approximation theorem we may assume that γ is a simplicial map from some subdivision L of the top edge of the square to $|N_2(\mathcal{U})|$. Now subdivide the square I^2 repeatedly to get a triangulation K with the property that if q_i is a vertex of K and $\text{st}(q_i)$ is the star of q_i in the barycentric subdivision K' , then

$$H(\text{st}(q_i)) \subset U_{\alpha(i)}$$

for some open set $U_{\alpha(i)}$ in \mathcal{U} . In the process of the subdivision new vertices are introduced on the top edge only by repeated bisection of the edge; furthermore, the function α on the vertices of the top edge may be chosen as follows. Consider for example the 1-simplex q_1q_2 . If q_k is a new vertex to the left of the midpoint q_{12} , choose $q(k) = \alpha(1)$; otherwise, choose $q(k) = \alpha(2)$.

Define

$$\bar{H}: I^2 = |K'| \rightarrow |N'_2(\mathcal{U})|$$

to be the simplicial map with

$$\bar{H}(q_i) = U_{\sigma(i)}.$$

The restriction β of \bar{H} to the top edge of the square agrees with γ on the vertices of L . Furthermore, by construction β is homotopic to γ in $|N_2(\mathcal{U})|$, and \bar{H} is a null-homotopy for β . Therefore, $f_*: \pi_1(|N_2(\mathcal{U})|) \rightarrow \pi_1(X)$ is injective. Since the nerve $N(\mathcal{U})$ and its 2-skeleton $N_2(\mathcal{U})$ have the same fundamental group (Remark 13.3 (a)), the theorem is proved. \square

Examples of Monodromy

EXAMPLE 13.5. Let S^1 be the unit circle in the complex plane with good cover $\mathcal{U} = \{U_0, U_1, U_2\}$ as in Figure 13.10. The map $\pi: z \rightarrow z^2$ defines a fiber bundle $\pi: S^1 \rightarrow S^1$ each of whose fibers consists of two distinct points. Let $F = \{A, B\}$ be the fiber above the point 1. The cohomology $H^*(F)$ consists of all functions on $\{A, B\}$, i.e., $H^*(F) = \{(a, b) \in \mathbb{R}^2\}$.

Fix an isomorphism $H^*(\pi^{-1}U_0) \simeq H^*(F)$. We have the diagram

$$\begin{array}{ccc}
 H^*(\pi^{-1}U_0) \simeq H^*(F) & & \\
 \downarrow & & \vdots \\
 H^*(\pi^{-1}U_{01}) & & \\
 \uparrow & & \vdots \\
 H^*(\pi^{-1}U_1) & & \\
 \downarrow & & \vdots \\
 H^*(\pi^{-1}U_{12}) & & \\
 \uparrow & & \vdots \\
 H^*(\pi^{-1}U_2) & & \\
 \downarrow & & \vdots \\
 H^*(\pi^{-1}U_{02}) & & \\
 \uparrow & & \vdots \\
 H^*(\pi^{-1}U_0) \simeq H^*(F) & &
 \end{array}$$

If we start with a generator, say $(1, 0)$, of $H^*(F)$ and follow it around the diagram, we do not end up with the same generator; in fact, we get $(0, 1)$. In general (a, b) goes to (b, a) . Therefore the presheaf $\mathcal{H}^*(U) = H^*(\pi^{-1}U)$ is not a constant presheaf.

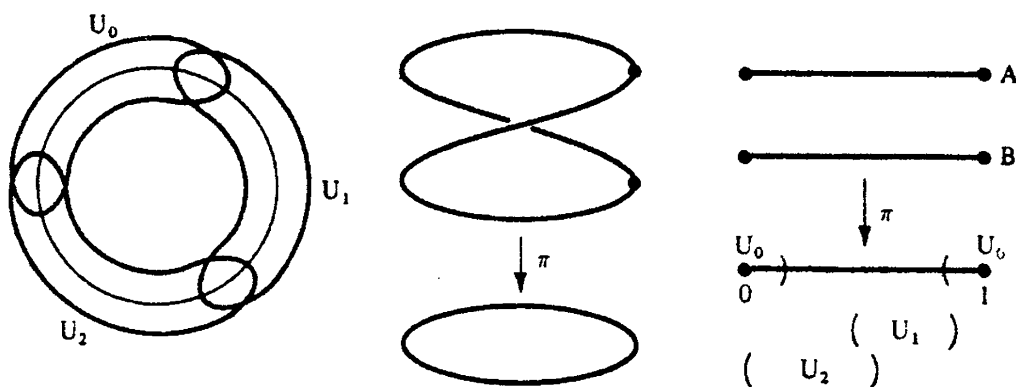

Figure 13.10

Exercise 13.6. Since H_d of the double complex $C^*(\pi^{-1}\mathcal{U}, \Omega^*)$ in Example 13.5 has only one nonzero row, we see by the generalized Mayer-Vietoris principle and Proposition 12.1 that

$$H^*(S^1) = H_D^*\{C^*(\pi^{-1}\mathcal{U}, \Omega^*)\} = H_d H_d = H^*(\mathcal{U}, \mathcal{H}^0).$$

Compute the Čech cohomology $H(\mathcal{U}, \mathcal{H}^0)$ directly.

EXAMPLE 13.7. The universal covering $\pi : \mathbb{R}^1 \rightarrow S^1$ given by $\pi(x) = e^{2\pi i x}$ is a fiber bundle with fiber a countable set of points. The action of the loop downstairs on the homology $H_0(\text{fiber})$ is translation by 1: $x \mapsto x + 1$. In cohomology a loop downstairs sends the function on the fiber with support at x to the function with support at $x + 1$. (See Figure 13.11.)

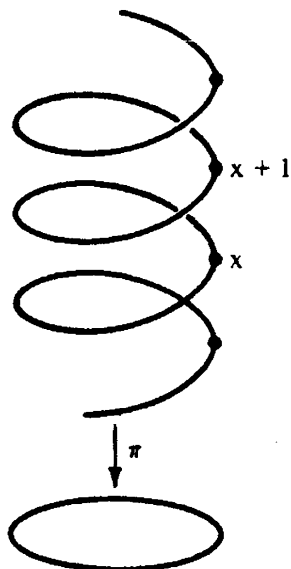

Figure 13.11

Exercise 13.8. As in Example 13.5, with \mathcal{U} being the usual good cover of S^1 ,

$$H^*(\mathbb{R}^1) = H_D^*\{C^*(\pi^{-1}\mathcal{U}, \Omega^*)\} = H_d H_d = H^*(\mathcal{U}, \mathcal{H}^0).$$

Compute $H^*(\mathcal{U}, \mathcal{H}^0)$ directly.

EXAMPLE 13.9. In the previous two examples, the fundamental group of the base acts on H_0 of the fiber. We now give an example in which it acts on H_2 .

The wedge $S^m \vee S^n$ of two spheres S^m and S^n is the union of S^m and S^n with one point identified. Let X be $S^1 \vee S^2$ as shown in Figure 13.12 and let \tilde{X} be the universal covering of X . Note that although $H^*(X)$ is finite, $H^*(\tilde{X})$ is infinite. We define a fiber bundle over the circle S^1 with fiber \tilde{X} by setting.

$$E = \tilde{X} \times I / (x, 0) \sim (s(x), 1)$$

where s is the deck transformation of the universal cover \tilde{X} which shifts everything one unit up. The projection $\pi : E \rightarrow S^1$ is given by $\pi(\tilde{x}, t) = t$. The fundamental group of the base $\pi_1(S^1)$ acts on $H_2(\text{fiber})$ by shifting each sphere one up.

Exercise 13.10. Find the homotopy type of the space E .

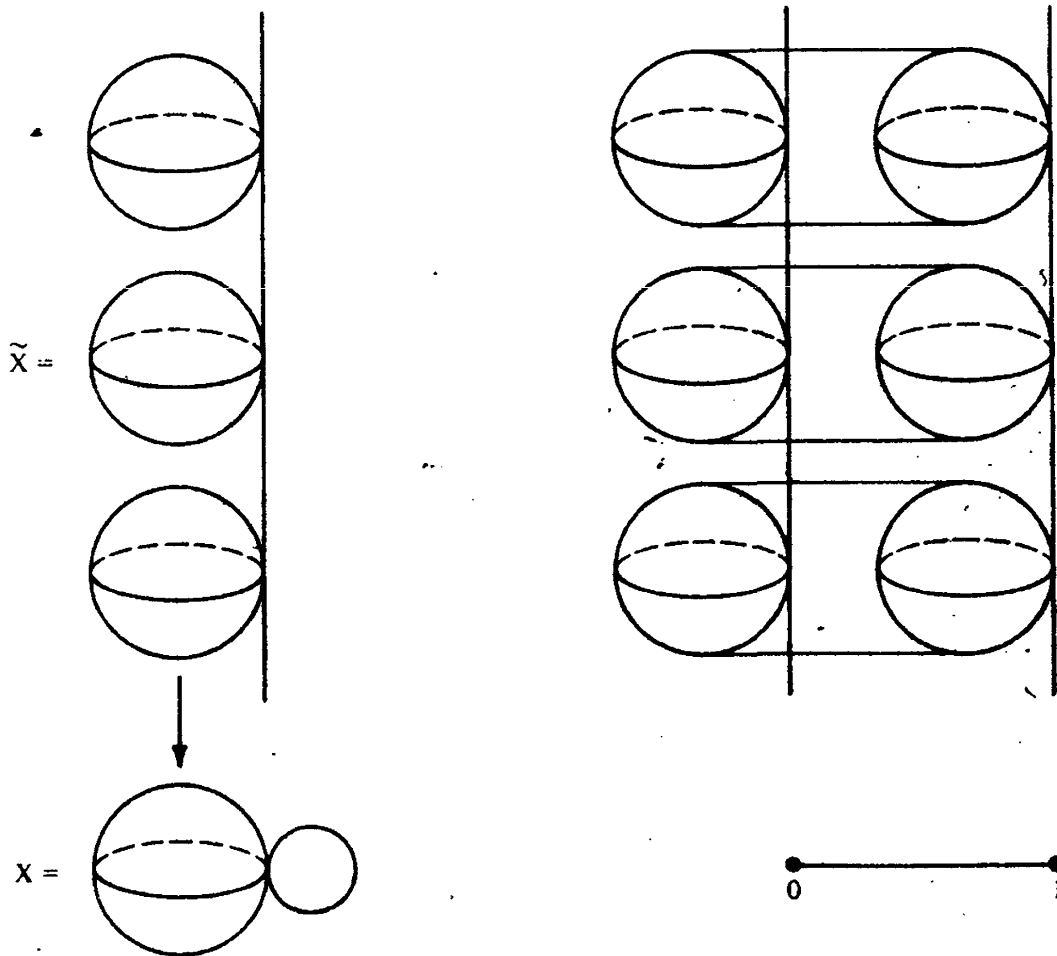

Figure 13.12

CHAPTER III

Spectral Sequences and Applications

This chapter begins with the abstract properties of spectral sequences and their relation to the double complexes encountered earlier. Then in Section 15 comes the crucial transition to integer coefficients. Many, but not all, of the constructions for the de Rham theory carry over to the singular theory. We point out the similarities and the differences whenever appropriate. In particular, there is a very brief discussion of the Künneth formula and the universal coefficient theorems in this new setting. Thereafter we apply the spectral sequences to the path fibration of Serre and compute the cohomology of the loop space of a sphere. The short review of homotopy theory that follows includes a digression into Morse theory, where we sketch a proof that compact manifolds are *CW* complexes. In connection with the computation of $\pi_3(S^2)$, we also discuss the Hopf invariant and the linking number and explore the rather subtle aspects of Poincaré duality concerned with the boundary of a submanifold. Returning to the spectral sequences, we compute the cohomology of certain Eilenberg–MacLane spaces. The Eilenberg–MacLane spaces may be pieced together into a twisted product that approximates a given space. They are in this sense the basic building blocks of homotopy theory. As an application, we show that $\pi_3(S^3) = \mathbb{Z}_2$. We conclude with a very brief introduction to the rational homotopy theory of Dennis Sullivan. A more detailed overview of this chapter may be obtained by reading the introductions to the various sections. One word about the notation: for simplicity we often omit the coefficients from the cohomology groups. This should not cause any confusion, as $H^*(X)$ always denotes the de Rham cohomology except in Sections 15 through 18, where in the context of the singular theory it stands for the singular cohomology.

§14 The Spectral Sequence of a Filtered Complex

By considering the double complex $C(\mathcal{U}, \Omega^*)$ of differential forms on an open cover, we generalized in Chapter II the key theorems of Chapter I. This double complex is a very degenerate case of an algebraic construction called the *spectral sequence*, a powerful tool in the computation of homology, cohomology and even homotopy groups. In this chapter we construct the spectral sequence of a filtered complex and apply it to a variety of situations, generalizing and reproving many previous results. Among the various approaches to the construction of a spectral sequence, perhaps the simplest is through exact couples, due to Massey [1].

Exact Couples

An *exact couple* is an exact sequence of Abelian groups of the form

$$\begin{array}{ccc} A & \xrightarrow{i} & A' \\ & \searrow k & \swarrow j \\ & B & \end{array}$$

where $i, j,$ and k are group homomorphisms. Define $d : B \rightarrow B$ by $d = j \circ k$. Then $d^2 = j(kj)k = 0$, so the homology group $H(B) = (\ker d)/(\text{im } d)$ is defined. Here A and B are assumed to be Abelian so that the quotient $H(B)$ is a group.

Out of a given exact couple we can construct a new exact couple, called the *derived couple*,

(14.1)
$$\begin{array}{ccc} A' & \xrightarrow{i'} & A' \\ & \searrow k' & \swarrow j' \\ & B' & \end{array}$$

by making the following definitions.

- (a) $A' = i(A); B' = H(B)$.
- (b) f' is induced from i ; to be precise,

$$i'(ia) = i(ia).$$

(c) If $a' = ia$ is in A' , with a in A , then $j'a' = [ja]$, where $[\]$ denotes the homology class in $H(B)$. To show that j' is well-defined we have to check two things:

- (i) ja is a cycle. This follows from $d(ja) = j(kj)a = 0$.
- (ii) The homology class $[ja]$ is independent of the choice of a .

Suppose $a' = i\bar{a}$ for some other \bar{a} in A . Then because $0 = i(a - \bar{a})$, we have $a - \bar{a} = kb$ for some b in B . Thus

$$ja - j\bar{a} = jkb = db,$$

so

$$[ja] = [j\bar{a}].$$

(d) k' is induced from k . Let $[b]$ be a homology class in $H(B)$. Then $jkb = 0$ so that $kb = ia$ for some a in A . Define

$$k'[b] = kb \in i(A).$$

It is straightforward to check that with these definitions, (14.1) is an exact couple. We will check the exactness at B' and leave the other steps to the reader.

(i) $\text{im } j' \subset \ker k'$:

$$k'j'(a') = k'j'(ia) = k'j(a) = kj(a) = 0.$$

(ii) $\ker k' \subset \text{im } j'$:

$$\text{Since } k'(b) = kb = 0, \text{ it follows that } b = j(a) = j'(ia) \in \text{im } j'.$$

The Spectral Sequence of a Filtered Complex

Let K be a differential complex with differential operator D ; i.e., K is an Abelian group and $D: K \rightarrow K$ is a group homomorphism such that $D^2 = 0$. Usually K comes with a grading $K = \bigoplus_{k \in \mathbb{Z}} C^k$ and $D: C^k \rightarrow C^{k+1}$ increases the degree by 1, but the grading is not absolutely indispensable. A *subcomplex* K' of K is a graded subgroup such that $DK' \subset K'$. A sequence of subcomplexes

$$K = K_0 \supset K_1 \supset K_2 \supset K_3 \supset \dots$$

is called a *filtration* on K . This makes K into a *filtered complex*, with *associated graded complex*

$$GK = \bigoplus_{p=0}^{\infty} K_p / K_{p+1}$$

For notational reasons we usually extend the filtration to negative indices by defining $K_p = K$ for $p < 0$.

EXAMPLE 14.2. If $K = \bigoplus K^{p,q}$ is a double complex with horizontal operator δ and vertical operator d , we can form a single complex out of it in the usual way, by letting $K = \bigoplus C^k$, where $C^k = \bigoplus_{p+q=k} K^{p,q}$, and defining the differential operator $D: C^k \rightarrow C^{k+1}$ to be $D = \delta + (-1)^p d$. Then the sequence of subcomplexes indicated below is a filtration on K :

$$K_p = \bigoplus_{i \geq p} \bigoplus_{q \geq 0} K^{i,q}$$

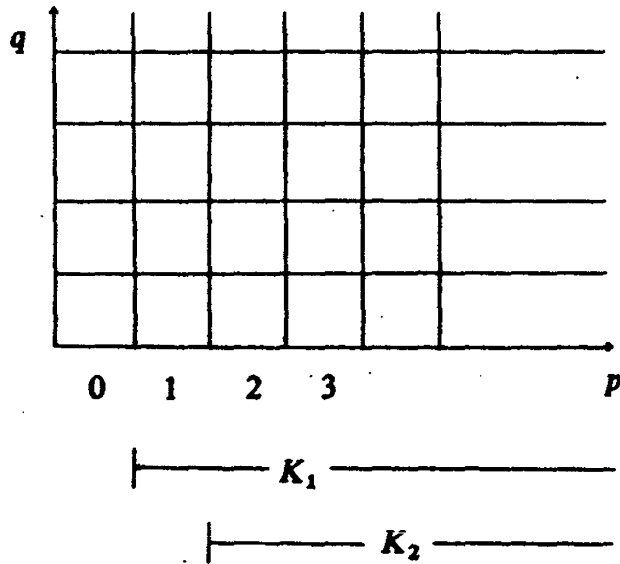

Returning to the general filtered complex K , let A be the group

$$A = \bigoplus_{p \in \mathbb{Z}} K_p.$$

A is again a differential complex with operator D . Define $i: A \rightarrow A$ to be the inclusion $K_{p+1} \hookrightarrow K_p$ and define B to be the quotient

$$(14.3) \quad 0 \rightarrow A \xrightarrow{i} A \xrightarrow{j} B \rightarrow 0.$$

Then B is the associated graded complex GK of K . In the short exact sequence (14.3) each group is a complex with operator induced from D . From this short exact sequence we get a long exact sequence of cohomology groups

$$\cdots \rightarrow H^k(A) \xrightarrow{i_1} H^k(A) \xrightarrow{j_1} H^k(B) \xrightarrow{k_1} H^{k+1}(A) \rightarrow \cdots,$$

which we may write as

$$\begin{array}{ccc} \begin{array}{ccc} H(A) & \xrightarrow{i_1} & H(A) \\ & \searrow k_1 & \swarrow j_1 \\ & H(B) & \end{array} & \stackrel{\text{def.}}{=} & \begin{array}{ccc} A_1 & \xrightarrow{i} & A_1 \\ & \searrow k_1 & \swarrow j_1 \\ & H(B) & \end{array} \end{array}$$

where the map i is no longer an inclusion. We suppress the subscript of i_1 to

avoid cumbersome notation later. Since this is an exact couple, it gives rise as in (14.1) to a sequence of exact couples:

$$\begin{array}{ccc} A_r & \xrightarrow{i} & A_r \\ & \swarrow k_r & \searrow i_r \\ & B_r & \end{array}$$

each being the derived couple of its predecessor.

For the sake of the exposition consider now the case where the filtered complex terminates after K_3 :

$$\cdots = K_{-1} = K_0 \supset K_1 \supset K_2 \supset K_3 \supset 0.$$

Then A_1 is the direct sum of all the terms in the following sequence

$$\cdots \approx H(K) \approx H(K) \xleftarrow{i} H(K_1) \xleftarrow{i} H(K_2) \xleftarrow{i} H(K_3) \leftarrow 0.$$

This is of course not an exact sequence. Next, A_2 by definition is the image of A_1 under i in A_1 and so is the direct sum of the groups in the sequence

$$\cdots \approx H(K) \approx H(K) \supset iH(K_1) \leftarrow iH(K_2) \leftarrow iH(K_3) \leftarrow 0.$$

Note that here the map $iH(K_1) \subset H(K)$ is an inclusion. Similarly A_3 is the sum of

$$\cdots \approx H(K) \approx H(K) \supset iH(K_1) \supset i^2H(K_2) \leftarrow i^2H(K_3) \leftarrow 0$$

and A_4 is the sum of

$$\approx H(K) \approx H(K) \supset iH(K_1) \supset i^2H(K_2) \supset i^3H(K_3) \supset 0.$$

Since all the maps become inclusions in A_4 , all the A 's are stationary after the fourth derived couple:

$$A_4 = A_5 = A_6 = \cdots = A_\infty.$$

Furthermore, since

$$\begin{array}{ccc} A_4 & \xrightarrow{i} & A_4 \\ & \swarrow k_4 & \searrow i \\ & B_4 & \end{array}$$

is exact and $i: A_4 \rightarrow A_4$ is the inclusion, the map $k_4: B_4 \rightarrow A_4$ must be the

zero map. Therefore, after the fourth stage all the differentials of the exact couples are zero and the B 's also become stationary,

$$B_4 = B_5 = B_6 = \cdots = B_\infty.$$

In the exact couple

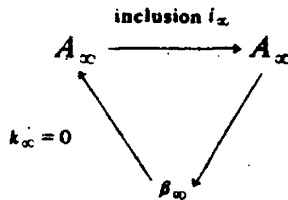

A_∞ is the direct sum of the groups

$$(14.4) \quad \cdots = H(K) = H(K) \supset iH(K_1) \supset iiH(K_2) \supset iiiH(K_3) \supset 0$$

and the inclusion i_∞ is as in (14.4). Since B_∞ is the quotient of i_∞ , it is the direct sum of the successive quotients in i_∞ . If we let (14.4) be the filtration on $H(K)$, then B_∞ is the associated graded complex of the filtered complex $H(K)$.

We now return to the general case. The sequence of subcomplexes

$$\cdots = K = K \supset K_1 \supset K_2 \supset K_3 \supset \cdots$$

induces a sequence in cohomology

$$\cdots \xleftarrow{i} H(K) \xleftarrow{i} H(K) \xleftarrow{i} H(K_1) \xleftarrow{i} H(K_2) \xleftarrow{i} H(K_3) \xleftarrow{i} \cdots,$$

where the maps i are of course no longer inclusions. Let F_p be the image of $H(K_p)$ in $H(K)$. Then there is a sequence of inclusions

$$(14.5) \quad H(K) = F_0 \supset F_1 \supset F_2 \supset F_3 \supset \cdots,$$

making $H(K)$ into a filtered complex; this filtration is called the *induced filtration* on $H(K)$.

A filtration K_p on the filtered complex K is said to have *length* ℓ if $K_p = 0$ for $p > \ell$. By the same argument as the special case above, we see that whenever the filtration on K has finite length, then A_r and B_r are eventually stationary and the stationary value B_∞ is the associated graded complex $\bigoplus F_p/F_{p+1}$ of the filtered complex $H(K)$ with filtration given by (14.5).

It is customary to write E_r for B_r . Hence,

$$\begin{aligned} E_1 &= H(B) \text{ with differential } d_1 = j_1 \circ k_1, \\ E_2 &= H(E_1) \text{ with differential } d_2, \\ E_3 &= H(E_2), \text{ etc.} \end{aligned}$$

A sequence of differential groups $\{E_r, d_r\}$ in which each E_r is the homology of its predecessor E_{r-1} is called a *spectral sequence*. If E_r eventually be-

comes stationary, we denote the stationary value by E_∞ , and if E_∞ is equal to the associated graded group of some filtered group H , then we say that the spectral sequence *converges* to H .

Now suppose the filtered complex K comes with a grading: $K = \bigoplus_{n \in \mathbb{Z}} K^n$. To distinguish the grading degree n from the filtration degree p , we will often call n the *dimension*. The filtration $\{K_p\}$ on K induces a filtration in each dimension: if $K_p^n = K^n \cap K_p$, then $\{K_p^n\}$ is a filtration on K^n .

For the applications we have in mind, the filtration on K need not have finite length. However, we can prove the following.

Theorem 14.6. *Let $K = \bigoplus_{n \in \mathbb{Z}} K^n$ be a graded filtered complex with filtration $\{K_p\}$ and let $H_D^*(K)$ be the cohomology of K with filtration given by (14.5). Suppose for each dimension n the filtration $\{K_p^n\}$ has finite length. Then the short exact sequence*

$$0 \rightarrow \bigoplus K_{p+1} \rightarrow \bigoplus K_p \rightarrow \bigoplus K_p / K_{p+1} \rightarrow 0$$

induces a spectral sequence which converges to $H_D^(K)$.*

PROOF. By treating the convergence question one dimension at a time, this proof reduces to the ungraded situation. To be absolutely sure, we will write out the details. As before,

$$A_r = \bigoplus_{p \in \mathbb{Z}} i^{r-1} H(K_p);$$

if $r \geq p + 1$, then $i^r H(K_p) = F_p$ and

$$i: i^r H(K_{p+1}) \rightarrow i^r H(K_p)$$

is an inclusion. With a grading on each derived couple, i and j preserve the dimension, but k increases the dimension by 1. Given n , let $\ell(n)$ be the length of $\{K_p^n\}_{p \in \mathbb{Z}}$ and let $r \geq \ell(n + 1) + 1$. Then for any integer p ,

$$i^r H^{n+1}(K_{p+1}) = F_{p+1}^{n+1}$$

and

$$i: i^r H^{n+1}(K_{p+1}) \rightarrow i^r H^{n+1}(K_p)$$

is an inclusion. It follows that

$$i_r: A_r^{n+1} \rightarrow A_r^{n+1}$$

is an inclusion and

$$k_r: B_r^n \rightarrow A_r^{n+1}$$

is the zero map. Therefore, as $r \rightarrow \infty$, the group B_r^n becomes stationary and we can define B_∞^n to be this stationary value. Note that

$$A_\infty^n = \bigoplus F_p^n$$

and that i_∞ sends F_{p+1}^n into F_p^n for every n . Because $i_\infty: \bigoplus F_{p+1} \rightarrow \bigoplus F_p$ is an inclusion, B_∞ is the associated graded complex $\bigoplus F_p/F_{p+1}$ of $H_B^*(K)$. \square

The Spectral Sequence of a Double Complex

Now let $K = \bigoplus K^{p,q}$ be a double complex with the filtration of Example 14.2. We will obtain a refinement of Theorem 14.6 for this special case by taking into account not only the particular filtration in question but also the bigrading and the presence of the two differential operators δ and d . The direct sum $A = \bigoplus K_p$ is also a double complex. Here, as always, we form a single complex $A = \bigoplus A^k$ out of this double complex by summing the bidegrees: A^k consists of all elements in A whose total degree is k . There is an inclusion $i: A^k \rightarrow A^k$ given by

$$i: A^k \cap K_{p+1} \rightarrow A^k \cap K_p.$$

The single complex A inherits the differential operator $D = \delta + (-1)^p d$ from K .

Similarly, $B = \bigoplus K_p/K_{p+1}$ can be made into a single complex with operator D . Note that the differential operator D on B is $(-1)^p d$; therefore,

$$(14.7) \quad E_1 = H_D(B) = H_d(K).$$

Recall that the coboundary operator $k_1: H(B) \rightarrow H(A)$ is the coboundary operator of the short exact sequence (14.3) and hence is defined by the following diagram:

$$(14.8) \quad \begin{array}{ccccccc} & & \uparrow & & \uparrow & & \uparrow \\ 0 & \longrightarrow & A^{k+1} \cap K_{p+1} & \xrightarrow{(3)} & A^{k+1} \cap K_p & \longrightarrow & B^{k+1} \cap K_p/K_{p+1} \longrightarrow 0 \\ & & \uparrow D & & \uparrow & & \uparrow D \\ & & A^k \cap K_{p+1} & \longrightarrow & A^k \cap K_p & \xrightarrow{(1)} & B^k \cap K_p/K_{p+1} \longrightarrow 0 \\ & & \uparrow & & \uparrow & & \uparrow \end{array}$$

Let b in $A^k \cap K_p$ represent a cocycle $[b]$ in $B^k \cap K_p/K_{p+1}$. This corresponds to Step (1) in the diagram. To get $k_1([b])$, we

- (2) compute Db and
- (3) take its inverse under i .

Since b represents an element of $E_1 = H_D(B) = H_d(K)$, $db = 0$ and $Db = \delta b + (-1)^p db = \delta b$. Thus $k_1([b]) = [\delta b]$; so the differential $d_1 = j_1 k_1$

on E_1 is given by δ (in fact by D , but $D = \delta$ on E_1). Consequently

$$(14.9) \quad E_2 = H_2 H_4(K).$$

We now compute the differential d_2 on E_2 . As noted in the proof of Proposition 12.1, an element of $E_2 = H_2 H_4(K)$ is represented by an element b in K such that

$$db = 0$$

$$\delta b = -D^r c \text{ for some } c \text{ in } K,$$

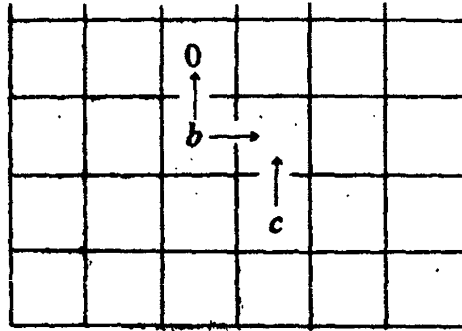

where $D^r = (-1)^r d$. We will denote the class of b in E_r , if it is defined, by $[b]_r$. From the definition of the derived couple (14.1),

$$d_2 [b]_2 = j_2 k_2 [b]_2 = j_2 k_1 [b]_1.$$

To compute $j_2 k_1 [b]_1$, we must find an a such that $k_1 [b]_1 = i[a]_1$. Then $j_2 k_2 [b]_2 = [j_1 a]_2$. Since $k_1 b$ is in $A^{k+1} \cap K_{p+1}$, a is in $A^{k+1} \cap K_{p+2}$. To find a we use not b but $b + c$ in $A^k \cap K_p$ to represent $[b]_2$ in Step (1); this is possible since b and $b + c$ have the same image under the projection $K_p \rightarrow K_p/K_{p+1}$. Then

$$k_1(b + c) = D(b + c) = \delta c.$$

So

$$(14.10) \quad d_2 [b]_2 = [\delta c]_2.$$

Thus the differential d_2 is given by the δ of the tail of the zig-zag which extends b . It is easy to show that δc represents an element of $H_2 H_4(K)$ and that the definition of $d_2 [b]_2$ is independent of the choice of c .

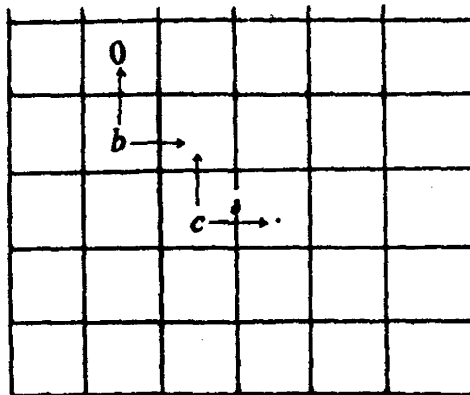

Exercise 14.11. Show that if $d_2[b]_2 = 0$, then there exist c_1 and c_2 so that b can be extended to a zig-zag as shown:

$$D''b = 0$$

$$\delta b = -D'c_1$$

$$\delta c_1 = -D''c_2.$$

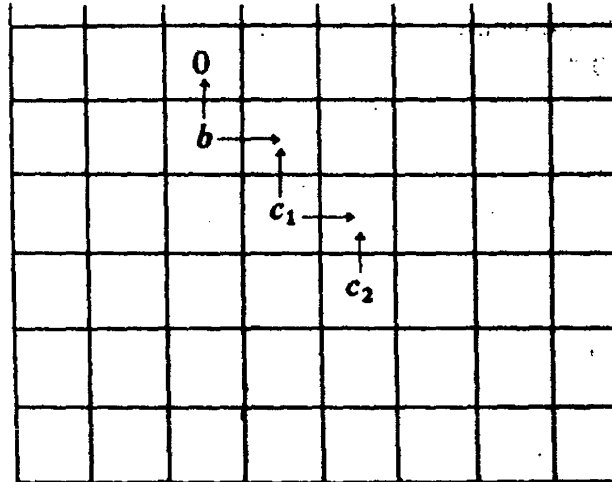

We say that an element b in K lives to E_r , if it represents a cohomology class in E_r ; equivalently, b is a cocycle in E_1, E_2, \dots, E_{r-1} . From the discussion above we see that b lives to E_2 if it can be extended to a zig-zag of length 2, the length of a zig-zag being the number of terms in it,

$$db = 0$$

$$\delta b = -D'c$$

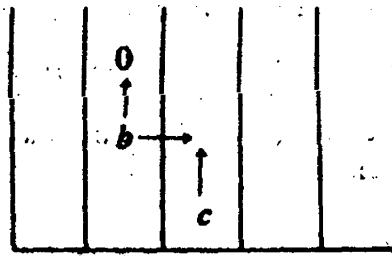

and $d_2[b]_2 = [\delta c]_2$; it lives to E_3 if it can be extended to a zig-zag of length 3:

$$db = 0$$

$$\delta b = -D'c_1$$

$$\delta c_1 = -D''c_2.$$

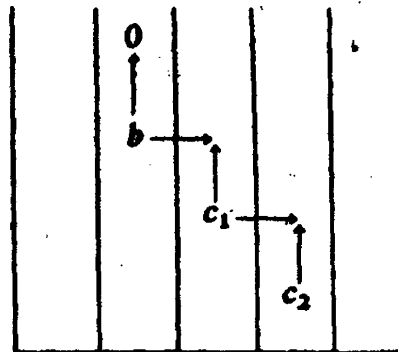

To compute $d_3[b]_3$, we use $b + c_1 + c_2$ in $A^k \cap K_p$ to represent $[b] \in B^k \cap (K_p/K_{p-1})$ in Step (1) of (14.8), so that $k_3 [b]_3$ is given by $D(b + c_1 + c_2) = \delta c_2$ and $d_3 [b]_3 = [\delta c_2]_3$. In general, parallel to the discussion above, an element b in $K^{p,q}$ lives to E_r , if it can be extended to a zig-zag of length r :

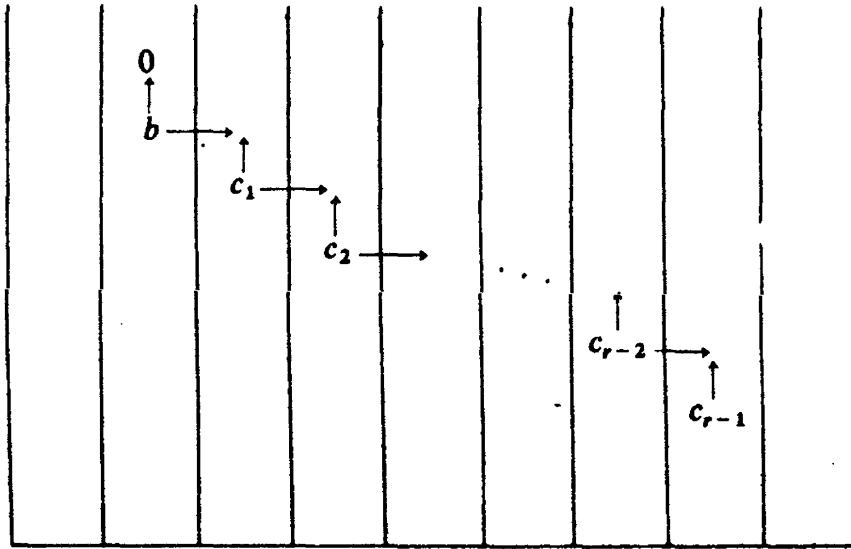

and the differential d_r on E_r is given by δ of the tail of the zig-zag:

$$(14.12) \quad d_r [b]_r = [\delta c_{r-1}]_r.$$

Thus the bidegrees (p, q) of the double complex $K = \bigoplus K^{p,q}$ persist in the spectral sequence

$$E_r = \bigoplus_{p,q} E_r^{p,q},$$

and d_r shifts the bidegrees by $(r, -r + 1)$:

$$d_r : E_r^{p,q} \rightarrow E_r^{p+r, q-r+1}.$$

The filtration on $H(K) = \bigoplus H^n(K)$:

$$H(K) = F_0 \supset F_1 \supset F_2 \supset \dots$$

induces a filtration on each component $H^n(K)$, the successive quotients of the filtration being $E_\infty^{0,n}, E_\infty^{1,n-1}, \dots, E_\infty^{n,0}$:

$$(14.13) \quad H^n(K) = \underbrace{(F_0 \cap H^n)}_{E_\infty^{0,n}} \supset \underbrace{(F_1 \cap H^n)}_{E_\infty^{1,n-1}} \supset \underbrace{(F_2 \cap H^n)} \supset \dots \supset \underbrace{(F_n \cap H^n)}_{E_\infty^{n,0}} \supset 0$$

This is best seen pictorially

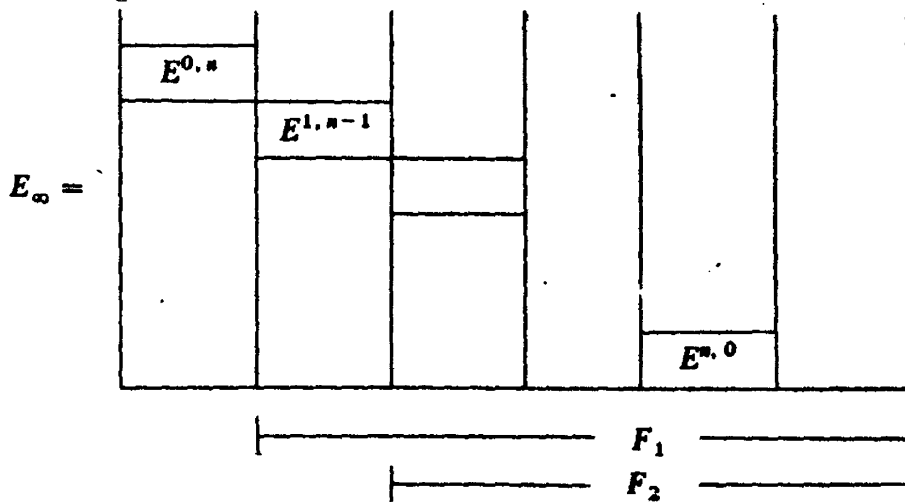

In summary, we have proved the following refinement of Theorem 14.6.

Theorem 14.14. *Given a double complex $K = \bigoplus_{p,q \geq 0} K^{p,q}$ there is a spectral sequence $\{E_r, d_r\}$ converging to the total cohomology $H_D(K)$ such that each E_r has a bigrading with*

$$d_r : E_r^{p,q} \rightarrow E_r^{p+r, q-r+1}$$

and

$$E_1^{p,q} = H_2^{p,q}(K),$$

$$E_2^{p,q} = H_2^{p,q} H_d(K);$$

furthermore, the associated graded complex of the total cohomology is given by

$$GH_D^*(K) = \bigoplus_{p+q=*} E_\infty^{p,q}(K).$$

REMARK 14.15. Of course, instead of the filtration in Example 14.2, we could just as well have given K the following filtration.

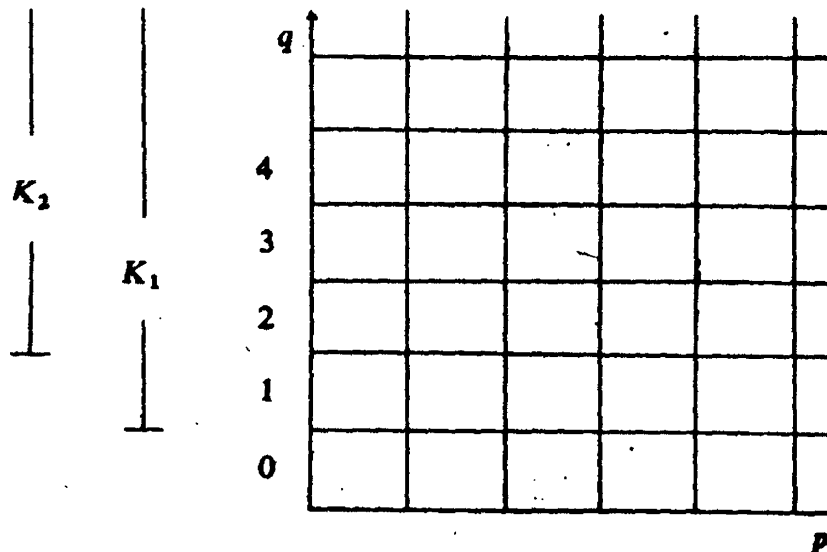

This gives a second spectral sequence $\{E_r', d_r'\}$ converging to the total cohomology $H_D(K)$, but with

$$E_1' = H_\delta(K),$$

$$E_2' = H_\delta H_\delta(K),$$

and

$$d_r' : E_r'^{p,q} \rightarrow E_r'^{p-r+1, q+r}.$$

EXAMPLE 14.16 (The Mayer-Vietoris principle and the isomorphism between de Rham and Čech). Let M be a manifold and \mathcal{U} a good cover on M . Consider the double complex $K = \bigoplus K^{p,q}$,

$$K^{p,q} = C^p(\mathcal{U}, \Omega^q) = \prod_{\alpha_0 < \dots < \alpha_p} \Omega^q(U_{\alpha_0 \dots \alpha_p})$$

Since the rows of K are the Mayer-Vietoris sequences, the E_1 term of the second spectral sequence is

$E_1' = H_\delta =$	$\Omega^3(M)$	0			
	$\Omega^2(M)$	0			
	$\Omega^1(M)$	0			
	$\Omega^0(M)$	0			

Therefore the E_2 term is

$E_2' = H_\delta H_\delta =$	$H_{DR}^3(M)$	0			
	$H_{DR}^2(M)$	0			
	$H_{DR}^1(M)$	0			
	$H_{DR}^0(M)$	0			

In general a spectral sequence is said to *degenerate at the E_r term* if $d_r = d_{r+1} = \dots = 0$. For such a spectral sequence $E_r = E_{r+1} = \dots = E_\infty$. The degeneration of the second spectral sequence of the double complex

$C^*(U, \Omega^*)$ at the E_2 term proves once again the Mayer-Vietoris principle (Proposition 8.8):

$$(14.16.1) \quad H_{DR}^k(M) = \bigoplus_{p+q=k} H_B^{p,q}\{C^*(U, \Omega^*)\}.$$

Now consider the first spectral sequence of $C^*(U, \Omega^*)$. Its E_1 term is

$$E_1^{p,q} = \prod_{a_0 < \dots < a_p} H^q(U_{a_0 \dots a_p}) = \begin{cases} 0 & \text{if } q > 0 \\ C^p(U, \mathbb{R}) & \text{if } q = 0. \end{cases}$$

$$E_1 = H_d = \begin{array}{|c|c|c|} \hline & & \\ \hline 0 & 0 & 0 \\ \hline C^0(U, \mathbb{R}) & C^1(U, \mathbb{R}) & C^2(U, \mathbb{R}) \\ \hline \end{array}$$

So the E_2 term is

$$E_2 = H_d H_d = \begin{array}{|c|c|c|} \hline & & \\ \hline H^0(U, \mathbb{R}) & H^1(U, \mathbb{R}) & H^2(U, \mathbb{R}) \\ \hline \end{array}$$

The degeneration of this spectral sequence gives

$$H^k(U, \mathbb{R}) = \bigoplus_{p+q=k} E_2^{p,q} = \bigoplus_{p+q=k} E_\infty^{p,q} = H_D^k\{C^*(U, \Omega^*)\}.$$

Together with (14.16.1) we get

$$H_{DR}^k(M) = H^k(U, \mathbb{R}) \quad \text{for all integers } k \geq 0.$$

This is the spectral sequence proof of the isomorphism between de Rham and Čech (Theorem 8.9).

REMARK 14.17. *The extension problem.* Because the dimension is the only invariant of a vector space, the associated graded vector space GV of a filtered vector space V is isomorphic to V itself. In particular, if the double complex K is a vector space, then

$$H_D^k(K) \simeq GH_D^k(K) \simeq \bigoplus_{p+q=k} E_\infty^{p,q}$$

However, in the realm of Abelian groups a knowledge of the associated graded group does not determine the group itself. For example, the two groups $Z_2 \oplus Z_2$ and Z_4 filtered by

$$Z_2 \subset Z_2 \oplus Z_2$$

and

$$Z_2 \subset Z_4$$

have isomorphic associated graded groups, but $Z_2 \oplus Z_2$ is not isomorphic to Z_4 . Put another way, in a short exact sequence of Abelian groups

$$0 \rightarrow A \rightarrow B \rightarrow C \rightarrow 0,$$

A and C do not determine B uniquely. The ambiguity is called the *extension problem* and lies at the heart of the subject known as homological algebra. For our purpose it suffices to be familiar with the following elementary facts from extension theory.

Proposition 14.17.1. *In a short exact sequence of Abelian groups*

$$0 \rightarrow A \xrightarrow{f} B \xrightarrow{g} C \rightarrow 0,$$

if A and C are free, then there exists a homomorphism $s: C \rightarrow B$ such that $g \circ s$ is the identity on C .

PROOF. Define s appropriately on the generators of C and extend linearly. \square

Corollary 14.17.2. *Under the hypothesis of the proposition,*

- (a) *the map $(f, s): A \oplus C \rightarrow B$ is an isomorphism;*
- (b) *for any Abelian group G the induced sequence*

$$0 \rightarrow \text{Hom}(C, G) \rightarrow \text{Hom}(B, G) \rightarrow \text{Hom}(A, G) \rightarrow 0$$

is exact;

- (c) *for any Abelian group G the sequence*

$$0 \rightarrow A \otimes G \rightarrow B \otimes G \rightarrow C \otimes G \rightarrow 0$$

is exact.

The proof is left to the reader.

Exercise 14.17.3. Show that if

$$0 \rightarrow A_1 \rightarrow A_2 \rightarrow A_3 \rightarrow \cdots$$

s an exact sequence of free Abelian groups and if G is any Abelian group,

then the two sequences

$$0 \leftarrow \text{Hom}(A_1, G) \leftarrow \text{Hom}(A_2, G) \leftarrow \text{Hom}(A_3, G) \leftarrow \cdots$$

and

$$0 \rightarrow A_1 \otimes G \rightarrow A_2 \otimes G \rightarrow A_3 \otimes G \rightarrow \cdots$$

are both exact.

Exercise 14.17.4. Show that if

$$0 \rightarrow A \rightarrow B \rightarrow C \rightarrow 0$$

is a short exact sequence of Abelian groups (which are not necessarily free) and G is any Abelian group, then the two sequences

$$0 \rightarrow \text{Hom}(C, G) \rightarrow \text{Hom}(B, G) \rightarrow \text{Hom}(A, G)$$

and

$$A \otimes G \leftarrow B \otimes G \leftarrow C \otimes G \leftarrow 0$$

are both exact.

The Spectral Sequence of a Fiber Bundle

Let $\pi : E \rightarrow M$ be a fiber bundle with fiber F over a manifold M . Applying Theorem 14.14 here gives a general method for computing the cohomology of E from that of F and M . Indeed, given a good cover \mathcal{U} of M , $\pi^{-1}\mathcal{U}$ is a cover on E and we can form the double complex

$$K^{p,q} = C^p(\pi^{-1}\mathcal{U}, \Omega^q) = \prod_{a_0 < \dots < a_p} \Omega^q(\pi^{-1}U_{a_0 \dots a_p}),$$

whose E_1 term is

$$E_1^{p,q} = H_1^{p,q} = \prod_{a_0 < \dots < a_p} H^q(\pi^{-1}U_{a_0 \dots a_p}) = C^p(\mathcal{U}, \mathcal{K}^q),$$

where \mathcal{K}^q is the presheaf $\mathcal{K}^q(U) = H^q(\pi^{-1}U)$ on M . For emphasis we sometimes write the presheaf \mathcal{K}^q as $\mathcal{K}^q(F)$. Since \mathcal{U} is a good cover, \mathcal{K}^q is a locally constant presheaf on \mathcal{U} with group $H^q(F)$ (Example {0.1}). Since $d_1 = \delta$ on E_1 , the E_2 term is

$$E_2^{p,q} = H_2^p(\mathcal{U}, \mathcal{K}^q).$$

By Theorem 14.14 the spectral sequence of K converges to $H_2^p(K)$, which by the Mayer-Vietoris principle is equal to $H^q(E)$, because $\pi^{-1}\mathcal{U}$ is a cover on E .

In case the base M is simply connected and $H^q(F)$ is finite-dimensional, Theorems 13.2 and 13.4 imply that \mathcal{K}^q is the constant presheaf $\mathbb{R} \oplus \dots \oplus \mathbb{R}$ on \mathcal{U} , consisting of $h^q(F)$ copies of \mathbb{R} where $h^q(F) = \dim H^q(F)$. So the

$E_2^{p,q}$ term is isomorphic as a vector space to the tensor product $H^p(M) \otimes H^q(F)$, since

$$\begin{aligned} E_2^{p,q} &= H^p(\mathcal{U}, \mathbb{R} \oplus \cdots \oplus \mathbb{R}) = H^p(\mathcal{U}, \mathbb{R}) \otimes H^q(F) \\ &= H^p(M) \otimes H^q(F), \end{aligned}$$

where the last equality follows from Theorem 8.9.

We have proven the following.

Theorem 14.18 (Leray's Theorem for de Rham Cohomology). *Given a fiber bundle $\pi : E \rightarrow M$ with fiber F over a manifold M and a good cover \mathcal{U} of M , there is a spectral sequence $\{E_r\}$ converging to the cohomology of the total space $H^*(E)$ with E_2 term*

$$E_2^{p,q} = H^p(\mathcal{U}, \mathcal{K}^q),$$

where \mathcal{K}^q is the locally constant presheaf $\mathcal{K}^q(U) = H^q(\pi^{-1}U)$ on \mathcal{U} . If M is simply connected and $H^q(F)$ is finite-dimensional, then

$$E_2^{p,q} = H^p(M) \otimes H^q(F).$$

Some Applications

EXAMPLE 14.19 (The Künneth formula and the Leray–Hirsch theorem). We now give a spectral sequence proof of the Künneth formula (5.9). Let M and F be two manifolds and \mathcal{U} a good cover of M . Suppose F has finite-dimensional cohomology. By Leray's theorem (14.18), the spectral sequence of the trivial bundle

$$\begin{array}{c} F \rightarrow M \times F \\ \downarrow \\ M \end{array}$$

has E_2 term

$$E_2^{p,q} = H^p(\mathcal{U}, \mathcal{K}^q(F)).$$

Because $M \times F$ is a trivial bundle over M , the presheaf $\mathcal{K}^q(F)$ is constant, so that

$$E_2^{p,q} = H^p(\mathcal{U}, \mathbb{R}) \otimes H^q(F) = H^p(M) \otimes H^q(F).$$

By (14.12) the differential d_r measures the extent to which an element of $C^*(\pi^{-1}\mathcal{U}, \Omega^*)$ that lives to E_r fails to be extended one step further to a D -cocycle. Since every element of the E_2 term is already a global form on

$M \times F$, $d_2 = d_3 = \dots = 0$. So $E_2 = E_\infty$, which by Theorem 14.18 is $H^*(M \times F)$. Therefore we have the Künneth formula

$$H^*(M \times F) = H^*(M) \otimes H^*(F).$$

The proof of the Leray-Hirsch theorem is analogous.

REMARK 14.20 (Orientability and the Euler class of a sphere bundle). Let $\pi : E \rightarrow M$ be an S^n -bundle over a manifold M and let \mathcal{U} be a good cover of M . The spectral sequence of this fiber bundle has

$$E_1^{p,q} = H_2^{p,q} = C^p(\mathcal{U}, \mathcal{K}^q(S^n)) =$$

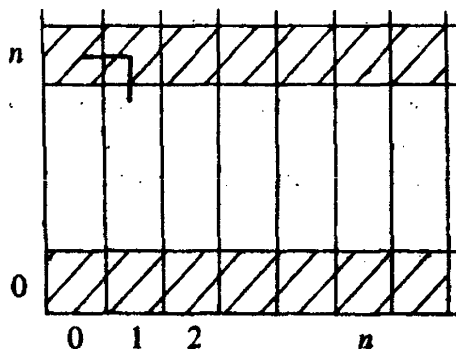

Let σ be the element of $E_1^{0,n} = C^0(\mathcal{U}, \mathcal{K}^n(S^n))$ corresponding to the local angular forms on the sphere bundle E . From the description of the differential d , as the δ of the tail of a zig-zag, we see that E is orientable if and only if $d_1\sigma = 0$ (compare with pp. 116–118). For an orientable S^n -bundle then, such a σ lives to E_n :

$$E_n = E_2 = H_2 H_2 = H^*(\mathcal{U}, \mathcal{K}^*(S^n)) =$$

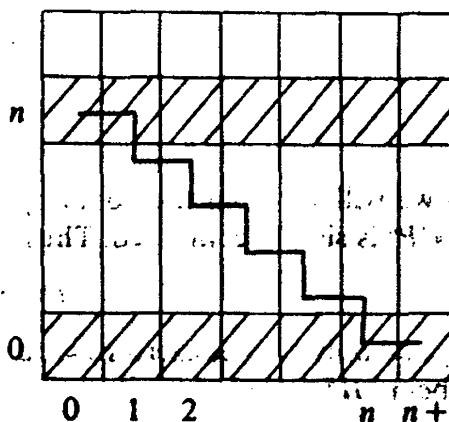

Up to a sign $d_n\sigma$ in $H^{n+1}(\mathcal{U}, \mathcal{K}^0(S^n)) = H^{n+1}(M)$ is the Euler class of the sphere bundle. It measures the extent to which σ fails to be extended to a D -cocycle, i.e., a global closed n -form on the sphere bundle.

EXAMPLE 14.21 (Orientability of a simply connected manifold). Let M be a simply connected manifold of dimension n and $S(T_M)$ its unit tangent

bundle. The spectral sequence of the fiber bundle

$$\begin{array}{c} S^{n-1} \rightarrow S(T_M) \\ \downarrow \\ M \end{array}$$

has E_2 term

$n-1$	\mathbb{R}	0			
0	\mathbb{R}	0			

This shows that there is an element in $C^0(\pi^{-1}U, \mathcal{H}^{n-1})$ which can be extended one step down toward being a D -cocycle. Therefore $S(T_M)$ and also M are orientable. This gives an alternative proof of the orientability of a simply connected manifold (Corollary 11.6).

EXAMPLE 14.22 (The cohomology of the complex projective space). Consider the sphere

$$S^{2n+1} = \{(z_0, \dots, z_n) \mid |z_0|^2 + \dots + |z_n|^2 = 1\}$$

in \mathbb{C}^{n+1} . Let S^1 act on S^{2n+1} by

$$(z_0, \dots, z_n) \mapsto (\lambda z_0, \dots, \lambda z_n),$$

where λ in S^1 is a complex number of absolute value 1. The quotient of S^{2n+1} by this action is the complex projective space CP^n . This gives S^{2n+1} the structure of a circle bundle over CP^n

$$\begin{array}{c} S^1 \rightarrow S^{2n+1} \\ \downarrow \\ CP^n \end{array}$$

As we will see from the homotopy exact sequence (17.4) to be discussed later, CP^n is simply connected. Thus

$$E_2^{p,q} = H^p(CP^n) \otimes H^q(S^1).$$

So E_2 has only two nonzero rows, $q = 0, 1$, and the two rows are identical, both being $H^*(CP^n)$.

Let $n = 2$. Then

$$E_2 = \begin{array}{cccccc} \mathbb{R} & A & B & C & D & 0 \\ \mathbb{R} & A & B & C & D & 0 \\ 0 & 1 & 2 & 3 & 4 & 5 \end{array}$$

where the bottom row is the cohomology of the base, $H^*(CP^2)$, and the 0-th column is the cohomology of the fiber. $H^p(CP^2) = 0$ for $p \geq 5$ because CP^2 has dimension 4. Since d_3 moves down two steps, $d_3 = 0$. Similarly,

$$d_4 = d_5 = \dots = 0.$$

So the spectral sequence degenerates at the E_3 term and $E_3 = E_4 = \dots = E_\infty = H^*(S^5)$. Therefore

$$E_3 = \begin{array}{c|c|c|c|c|c|c|c} \hline & & & & & & & \\ \hline & 0 & 0 & 0 & 0 & \mathbb{R} & 0 & \\ \hline & \mathbb{R} & 0 & 0 & 0 & 0 & 0 & \\ \hline & 0 & 1 & 2 & 3 & 4 & 5 & \\ \hline \end{array}$$

This means

$$\begin{aligned} d_2 : \mathbb{R} &\rightarrow B, & B &\rightarrow D, \\ 0 &\rightarrow A, & A &\rightarrow C, & C &\rightarrow 0 \end{aligned}$$

must all be isomorphisms. It follows that

$$E_2 = \begin{array}{c|c|c|c|c|c|c|c} \hline & & & & & & & \\ \hline & \mathbb{R} & 0 & \mathbb{R} & 0 & \mathbb{R} & 0 & \\ \hline & \mathbb{R} & 0 & \mathbb{R} & 0 & \mathbb{R} & 0 & \\ \hline & 0 & 1 & 2 & 3 & 4 & 5 & \\ \hline \end{array}$$

Therefore,

$$H^*(CP^2) = \begin{cases} \mathbb{R} & \text{in dimensions } 0, 2, 4 \\ 0 & \text{otherwise.} \end{cases}$$

Exercise 14.22.1. Show that

$$H^*(CP^n) = \begin{cases} \mathbb{R} & \text{in dimensions } 0, 2, 4, \dots, 2n \\ 0 & \text{otherwise.} \end{cases}$$

Exercise 14.23 (Algebraic Künneth Formula). Let E and F be graded differential algebras over \mathbb{R} with differential operators δ and d respectively. Define a differential operator D on the tensor product $E \otimes F$ by

$$D(e \otimes f) = (\delta e) \otimes f + (-1)^{\deg e} e \otimes df.$$

Prove by a spectral sequence argument that

$$H_D(E \otimes F) = H_\delta(E) \otimes H_d(F).$$

Product Structures

In this section we define product structures on the Čech-de Rham complex $C^*(\mathcal{U}, \Omega^*)$, the de Rham cohomology, and the Čech cohomology, and show that the isomorphism between de Rham and Čech is an isomorphism of graded algebras. We also discuss the product structures on a spectral sequence.

Let Z be the closed forms and B the exact forms on a manifold M . From the antiderivation property of the exterior derivative

$$d(\omega \cdot \eta) = (d\omega) \cdot \eta + (-1)^{\deg \omega} \omega \cdot d\eta,$$

it follows that Z is a subring of $\Omega^*(M)$ and B is an ideal in Z . Hence the wedge product makes the de Rham cohomology $H_{DR}^*(M) = Z/B$ into a graded algebra.

On the double complex $C^*(\mathcal{U}, \Omega^*)$, where \mathcal{U} is any open cover of M , a natural product

$$\cup : C^p(\mathcal{U}, \Omega^q) \otimes C^r(\mathcal{U}, \Omega^s) \rightarrow C^{p+r}(\mathcal{U}, \Omega^{q+s})$$

can be defined as follows. If ω is in $C^p(\mathcal{U}, \Omega^q)$ and η is in $C^r(\mathcal{U}, \Omega^s)$, then

$$(14.24) \quad (\omega \cup \eta)_{a_0 \dots a_{p+r}} = (-1)^{qr} \omega_{a_0 \dots a_p} \cdot \eta_{a_{p+1} \dots a_{p+r}},$$

where on the right-hand side both forms are understood to be restricted to $U_{a_0 \dots a_{p+r}}$.

REMARK 14.25. The sign $(-1)^{qr}$ is needed to make the differential operator D into an antiderivation relative to the product structure. It makes sense that this should be the sign, for in defining the product, p and r are brought together, and so are q and s , so the order of q and r in $C^p(\mathcal{U}, \Omega^q) \otimes C^r(\mathcal{U}, \Omega^s)$ are interchanged. It is a useful principle that whenever two symbols of degrees m and n are interchanged in a graded algebra, there should be the sign $(-1)^{mn}$.

Exercise 14.26. Let $\omega \in K^{p,q}$ and $\eta \in K^{r,s}$. Show that

- 1) $\delta(\omega \cup \eta) = (\delta\omega) \cup \eta + (-1)^{\deg \omega} \omega \cup \delta\eta$
 - 2) $D^r(\omega \cup \eta) = (D^r\omega) \cup \eta + (-1)^{\deg \omega} \omega \cup D^r\eta$
 - 3) $D(\omega \cup \eta) = (D\omega) \cup \eta + (-1)^{\deg \omega} \omega \cup D\eta$,
- where $\deg \omega = p + q$.

We will often write $\omega \cdot \eta$ or even $\omega\eta$ for $\omega \cup \eta$.

The inclusion of the Čech complex $C^*(\mathcal{U}, \mathbb{R})$ in the Čech-de Rham complex induces a product structure on $C^*(\mathcal{U}, \mathbb{R})$: if ω is a p -cochain and η an r -cochain, then

$$(14.27) \quad (\omega \cdot \eta)_{a_0 \dots a_{p+r}} = \omega_{a_0 \dots a_p} \cdot \eta_{a_{p+1} \dots a_{p+r}}.$$

By Exercise 14.26, δ is an antiderivation relative to this product. So just as in the case of de Rham cohomology this makes the Čech cohomology $H^*(\mathcal{U}, \mathbb{R})$ into a graded algebra. If \mathfrak{B} is a refinement of \mathcal{U} , then the restriction map $H^*(\mathcal{U}, \mathbb{R}) \rightarrow H^*(\mathfrak{B}, \mathbb{R})$ is a homomorphism of algebras. Hence the direct limit $H^*(M, \mathbb{R})$ is also a graded algebra. Note that (14.27) also makes sense for the Čech complex $C^*(\mathcal{U}, \mathbb{R})$ on a topological space X ; this gives a product structure on the Čech cohomology $H^*(X, \mathbb{R})$ of any topological space X .

With the product structures just defined, both inclusions

$$r : \Omega^*(M) \rightarrow C^*(\mathcal{U}, \Omega^*)$$

and

$$i : C^*(\mathcal{U}, \mathbb{R}) \rightarrow C^*(\mathcal{U}, \Omega^*)$$

are algebra homomorphisms. Since as we saw in Proposition 8.8, for a good cover these homomorphisms induce bijective maps in cohomology

$$\begin{aligned} H_{DR}^*(M) &\simeq H_D\{C^*(\mathcal{U}, \Omega^*)\} \\ H^*(\mathcal{U}, \mathbb{R}) &\simeq H_D\{C^*(\mathcal{U}, \Omega^*)\}, \end{aligned}$$

the isomorphism between $H_{DR}^*(M)$ and $H^*(\mathcal{U}, \mathbb{R})$ is an algebra isomorphism. Because $H^*(M, \mathbb{R}) = H^*(\mathcal{U}, \mathbb{R})$ for a good cover \mathcal{U} , we have the following.

Theorem 14.28. *The isomorphism between de Rham and Čech*

$$H_{DR}^*(M) \simeq H^*(M, \mathbb{R})$$

is an isomorphism of graded algebras.

If a double complex K has a product structure relative to which its differential D is an antiderivation, the same is true of all the groups E_r and their operators d_r , since E_r is the homology of E_{r-1} and d_r is induced from D . With product structures, Theorem 14.14 becomes

Theorem 14.29 *Let K be a double complex with a product structure relative to which D is an antiderivation. There exists a spectral sequence*

$$\{E_r, d_r : E_r^{p,q} \rightarrow E_r^{p+r, q-r+1}\}$$

converging to $H_D(K)$ with the following properties:

- 1) *The $E_2^{p,q}$ term is $H_D^{p,q} H_A(K)$.*
- 2) *Each E_r , being the homology of its predecessor E_{r-1} , inherits a product structure from E_{r-1} . Relative to this product, d_r is an antiderivation.*

WARNING. Although both E_∞ and $H_D(K)$ inherit their ring structures from K , they are generally not isomorphic as rings.

Exercise 14.30 The product structure on the tensor product $A \otimes B$ of two graded rings A and B is given by

$$(a \otimes b)(c \otimes d) = (-1)^{(\deg b)(\deg c)}(ac \otimes bd), \quad a, c \in A, \quad b, d \in B.$$

Show that if $\pi : E \rightarrow M$ is a fiber bundle with fiber F over a simply connected manifold M , then the isomorphism of the E_2 term of the spectral sequence with $H^*(M) \otimes H^*(F)$ is an isomorphism of graded algebras.

REMARK 14.31. Thus in Leray's theorem (Theorem 14.18) each group E_r is an algebra relative to which d_r is an antiderivation; furthermore, if M is simply connected, E_2 is isomorphic to $H^*(M) \otimes H^*(F)$ as a graded algebra.

EXAMPLE 14.32 (The ring structure of $H^*(\mathbb{C}P^n)$). Assume for now that $n = 2$. In example 14.22, by applying the spectral sequence of the fiber bundle

$$\begin{array}{ccc} S^1 & \rightarrow & S^3 \\ & & \downarrow \\ & & \mathbb{C}P^2, \end{array}$$

we computed the additive structure of the graded algebra $H^*(\mathbb{C}P^2)$. We found that the E_2 term is

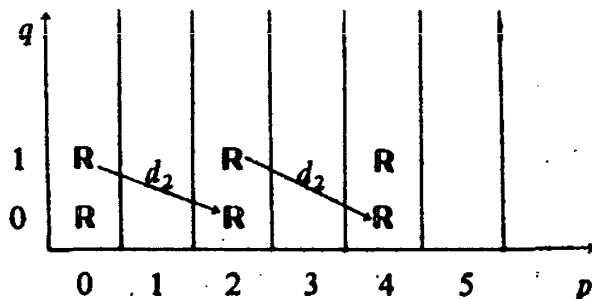

The two d_2 's shown are isomorphisms. Let a be a generator of

$$E_2^{0,1} \simeq H^0(\mathbb{C}P^1) \otimes H^1(S^1) \simeq H^1(S^1).$$

Then $d_2 a = x$ is a generator of

$$E_2^{2,0} \simeq H^2(\mathbb{C}P^1) \otimes H^0(S^1) \simeq H^2(\mathbb{C}P^1)$$

and $x \cdot a$ is a generator of

$$E_2^{2,1} = H^2(\mathbb{C}P^1) \otimes H^1(S^1).$$

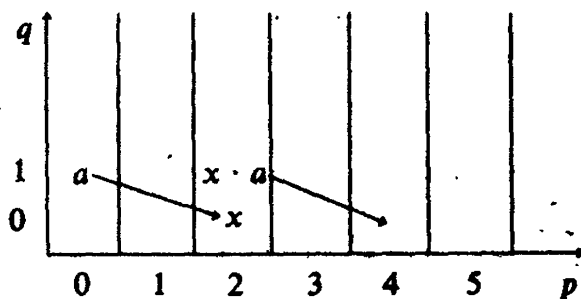

Because $d_2 : E_2^{2,1} \rightarrow E_2^{4,0}$ is an isomorphism, a generator of $E_2^{4,0} = H^4(\mathbb{C}P^2)$ is

$$d_2(x \cdot a) = x \cdot d_2 a = x^2.$$

So as a ring,

$$H^*(\mathbb{C}P^2) = \mathbb{R}[x]/(x^3).$$

In general, the same argument yields the ring structure of $\mathbb{C}P^n$ as

$$H^*(\mathbb{C}P^n) = \mathbb{R}[x]/(x^{n+1}),$$

where x is an element in dimension 2.

The Gysin Sequence

The spectral sequence of a fiber bundle is essentially a way of describing the complicated algebraic relations among the cohomology of the base space, the fiber, and the total space of the bundle. In certain special situations the spectral sequence simplifies to a long exact sequence. One such special case is the cohomology of a sphere bundle. The resulting sequence is called the *Gysin sequence*, which we now derive.

Let $\pi : E \rightarrow M$ be an oriented sphere bundle with fiber S^k . By the orientability assumption, for any good cover \mathcal{U} on M , the locally constant presheaf \mathcal{N}^q has no monodromy and is the constant presheaf \mathbb{R} . Therefore the E_2 term of the spectral sequence is

$$E_2^{p,q} = H^p(M) \otimes H^q(S^k).$$

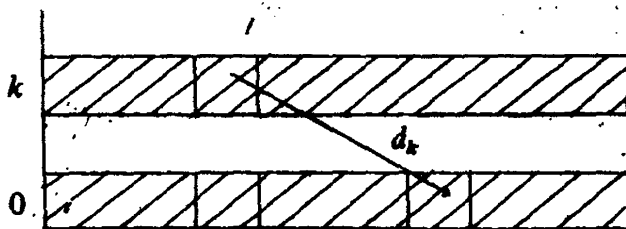

Let n be any nonnegative integer. Since nothing in $E_2^{n-k,k}$ can get killed (that is, nothing there lies in the image of d_r for $r \geq 2$), $E_\infty^{n-k,k}$ is the sub-

group of $E_2^{n-k,k}$ consisting of those elements with $d_3 = d_4 = \dots = 0$. Hence there is an inclusion

$$0 \rightarrow E_\infty^{n-k,k} \rightarrow E_2^{n-k,k}.$$

This can be extended to an exact sequence

$$(*) \quad 0 \rightarrow E_\infty^{n-k,k} \rightarrow E_2^{n-k,k} \xrightarrow{d_k} E_2^{n+1,0} \rightarrow E_\infty^{n+1,0} \rightarrow 0,$$

$$\parallel \qquad \parallel$$

$$H^{n-k}(M) \quad H^{n+1}(M)$$

where the last map, called an *edge homomorphism*, exists and is surjective because every element of $E_2^{n+1,0}$ survives to E_∞ .

Because of the shape of the E_2 term, the filtration (14.13) on $H^n(E)$ becomes

$$H^n(E) \supset \underbrace{E_\infty^{n,0}}_{E_\infty^{n-k,k}} \supset 0;$$

in other words, there is an exact sequence

$$(**) \quad 0 \rightarrow E_\infty^{n,0} \rightarrow H^n(E) \rightarrow E_\infty^{n-k,k} \rightarrow 0.$$

The two sequences (*) and (**) may be combined into a single long exact sequence

$$\dots \rightarrow H^n(E) \xrightarrow{\alpha} H^{n-k}(M) \xrightarrow{d_k} H^{n+1}(M) \xrightarrow{\beta} H^{n+1}(E) \rightarrow \dots$$

This is the *Gysin sequence* of the sphere bundle.

It remains to identify the maps in the Gysin sequence. Let \mathcal{U} be a good cover on M . The map α is the composition of

$$\begin{aligned} H^n(E) &\xrightarrow{\text{projection}} E_\infty^{n-k,k} \subset E_2^{n-k,k} = H^{n-k}(\pi^{-1}\mathcal{U}, \mathcal{X}^k) \\ &= H^{n-k}(M) \otimes H^k(S^k) \cong H^{n-k}(M). \end{aligned}$$

In this sequence of maps the first three are the identity on the level of forms and the last one sends a generator of $H^k(S^k)$ to 1 by integration. Therefore α is integration along the fiber.

Next consider d_k . Representing an element of

$$E_2^{n-k,k} = H^{n-k}(M) \otimes H^k(S^k)$$

by $(\pi^*\omega) \wedge (-\psi)$, where ω is a closed form on M and ψ is the angular form on E , we see that

$$\begin{aligned} d_k((\pi^*\omega) \wedge (-\psi)) &= d_k(\pi^*\omega) \wedge (-\psi) = (-1)^{n-k}(\pi^*d\omega) \wedge (-\psi) \\ &= (-1)^{n-k}(\pi^*d\omega) \wedge (\pi^*e). \end{aligned}$$

Hence, up to a sign $d_k : H^{n-k}(M) \rightarrow H^{n+1}(M)$ is multiplication by the Euler class e .

Finally the map β is the composition

$$\begin{aligned} H^{n+1}(M) &= H^{n+1}(\mathcal{U}, \mathcal{K}^0(F)) \xrightarrow{\pi^*} H^{n+1}(\pi^{-1}\mathcal{U}, \mathcal{K}^0(F)) \\ &= E_2^{n+1,0} \xrightarrow{\text{projection}} E_\infty^{n+1,0} \subset H^{n+1}(E). \end{aligned}$$

So $\beta : H^{n+1}(M) \rightarrow H^{n+1}(E)$ is the natural pullback map π^* .

We summarize this discussion as follows.

Proposition 14.33. *Let $\pi : E \rightarrow M$ be an oriented sphere bundle with fiber S^k . Then there is a long exact sequence*

$$\cdots \rightarrow H^n(E) \xrightarrow{\pi_*} H^{n-k}(M) \xrightarrow{\wedge e} H^{n+1}(M) \xrightarrow{\pi^*} H^{n+1}(E) \rightarrow \cdots,$$

in which the maps π_* , $\wedge e$, and π^* are integration along the fiber, multiplication by the Euler class, and the natural pullback, respectively.

Exercise 14.33.1. Show that if the sphere bundle comes from a vector bundle $\pi : V \rightarrow M$, then the long exact sequence in the proposition may be identified with the relative exact sequence of the inclusion $i : V^0 \rightarrow V$, where V^0 is the complement of the zero section in V . (Compare with Proposition 6.49.)

Leray's Construction

We consider now more generally not a fiber bundle but any map $\pi : X \rightarrow Y$ from one manifold to another, and study how the cohomology groups of X relate to those of Y . Let \mathcal{U} be any cover for Y , not necessarily a good cover. Then $\pi^{-1}\mathcal{U}$ is a cover for X . By the Mayer-Vietoris principle (Proposition 8.8 or 14.16)

$$H^*(X) = H_D\{C^*(\pi^{-1}\mathcal{U}, \Omega^*)\}.$$

By Theorem 14.14, if K is the double complex $C^*(\pi^{-1}\mathcal{U}, \Omega^*)$ on X , then the spectral sequence of K has

$$E_\infty = H_D\{C^*(\pi^{-1}\mathcal{U}, \Omega^*)\}$$

and

$$E_2^{p,q} = H_p^q\{H_d\{C^*(\pi^{-1}\mathcal{U}, \Omega^*)\}\}.$$

$$K = \left[\begin{array}{c} \prod \Omega^{q+1}(\pi^{-1}U_{\alpha_0 \dots \alpha_p}) \\ \prod_{\alpha_0 < \dots < \alpha_p} \Omega^q(\pi^{-1}U_{\alpha_0 \dots \alpha_p}) \end{array} \right]$$

$$H_d(K) = \left[\begin{array}{cc} \prod H^q(\pi^{-1}U_{\alpha_0 \dots \alpha_p}) & \prod H^q(\pi^{-1}U_{\alpha_0 \dots \alpha_{p+1}}) \end{array} \right]$$

Here

$$H_2^{p,q}(K) = \prod_{\alpha_0 < \dots < \alpha_p} H^q(\pi^{-1}U_{\alpha_0 \dots \alpha_p}) = C^p(\mathcal{U}, \mathcal{K}^q)$$

where \mathcal{K}^q is the presheaf on Y defined by $\mathcal{K}^q(U) = H^q(\pi^{-1}U)$. In summary, there is a spectral sequence converging to $H^*(X)$ with E_2 term

$$E_2^{p,q} = H^p(\mathcal{U}, \mathcal{K}^q).$$

The main difference between this situation and that of a fiber bundle (Theorem 14.18) is that the presheaf \mathcal{K}^q is no longer locally constant on \mathcal{U} ; indeed the groups $H^q(\pi^{-1}U)$ will in general be different for different contractible open sets U .

EXAMPLE 14.34. Consider the vertical projection of a circle S^1 onto a segment I . Cover I with three open sets U_0, U_1, U_2 as shown in Figure 14.1.

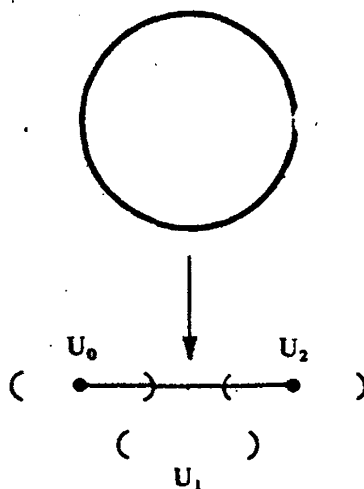
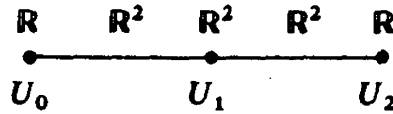
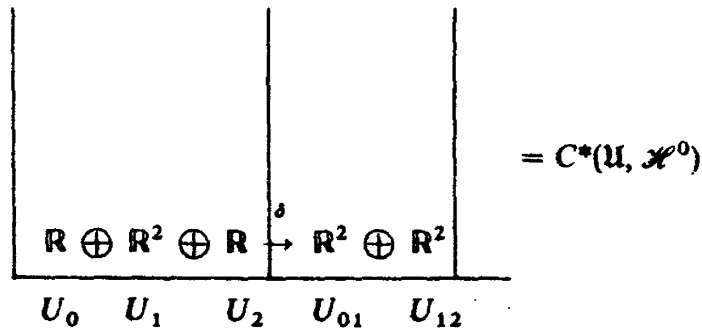

Figure 14.1

The presheaf \mathcal{K}^0 attaches a group to each vertex and each edge of the nerve $N(\mathcal{U})$ in the way indicated below



H_d of the double complex $C^*(\pi^{-1}\mathcal{U}, \Omega^*)$ is



with δ given by $(b, (c_1, c_2), d) \rightarrow ((c_1 - b, c_2 - b), (d - c_1, d - c_2))$. Thus $\ker \delta = \{(b, (b, b), b)\}$ and $H_\delta^0 \cdot {}^0H_d = \mathbb{R}$. Since $\text{im } \delta$ is 3-dimensional, $H_\delta^1 \cdot {}^0H_d = \mathbb{R}$. So $H_\delta H_d$ is

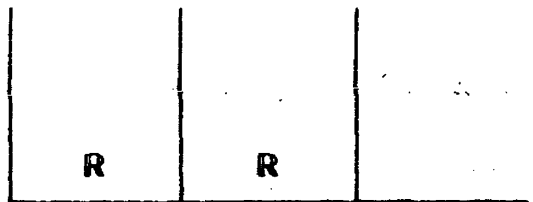

In this case, then, $E_2 = E_\infty$ and we get the cohomology of S^1 .

Let us find a nontrivial 1-cochain in $C^1(\mathcal{U}, \mathcal{K}^0)$ that represents a generator of $H^1(S^1)$. A 1-cochain in $C^1(\mathcal{U}, \mathcal{K}^0)$ is given by a 4-tuple $((r, s), (t, u))$. Such a 4-tuple is exact if and only if $r - s = u - t$. Therefore as a generator of $H^1(S^1)$ we may take $((1, 0), (0, 0))$, i.e., the 1-cochain τ (see Figure 14.2)

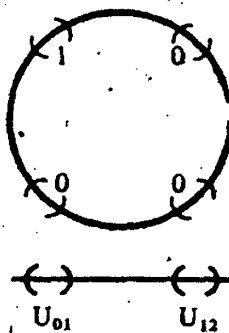

Figure 14.2

such that

$$\tau(U_{01}) = (1, 0)$$

$$\tau(U_{12}) = (0, 0).$$

Exercise 14.35. Project the sphere S^2 to a disc D (Figure 14.3) and compute $H^*(S^2)$ by Leray's method.

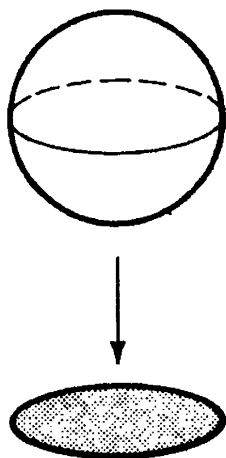

Figure 14.3

Exercise 14.36. Let Y be a manifold and \mathcal{U} a good cover of Y . Denote by β_p the number of nonempty $(p+1)$ -fold intersections $U_{a_0 \dots a_p}$. Show that $\chi(Y) = \sum (-1)^p \beta_p$.

Exercise 14.37. Let $\pi : X \rightarrow Y$ be any map and \mathcal{U} a good cover of Y . Show that

$$\chi(X) = \sum_p \sum_{a_0 < \dots < a_p} (-1)^{p+q} \dim H^q(\pi^{-1}U_{a_0 \dots a_p}).$$

Deduce that if $\pi : X \rightarrow Y$ is a fiber bundle with fiber F , then

$$\chi(X) = \chi(F) \chi(Y).$$

§15 Cohomology with Integer Coefficients

An element in a \mathbb{Z} -module is said to be *torsion* if some integral multiple of it is zero. Since the de Rham theory is a cohomology theory with real coefficients, it necessarily overlooks the torsion phenomena. For applications to homotopy theory, however, it is essential to investigate the torsion. The goal of this section is to replace the differential form functor Ω^* with the singular cochain functor S^* , define the singular cohomology, and show that the preceding results on spectral sequences carry over to integer coefficients. The key as before is the Mayer-Vietoris sequence for countably many open sets. The natural setting for the singular theory is the category

of topological spaces and continuous maps, rather than the more restrictive category of differentiable manifolds and C^∞ maps of de Rham theory. Unless otherwise indicated, from here till the end of Section 18 we will work in the continuous category. We begin with a review of the basic definitions of singular homology.

Singular Homology

Via the map

$$(x_1, \dots, x_n) \mapsto (x_1, \dots, x_n, 0)$$

each Euclidean space \mathbb{R}^n is naturally included in \mathbb{R}^{n+1} . Viewing each \mathbb{R}^n as a subspace of \mathbb{R}^{n+1} in this way we consider the union

$$\mathbb{R}^\infty = \bigcup_{n \geq 0} \mathbb{R}^n.$$

Denote by P_i the i -th standard basis vector in \mathbb{R}^∞ ; it is the vector whose i -th component is 1 and whose other components are all 0. Let P_0 be the origin. We define the *standard q -simplex* Δ_q to be the set

$$\Delta_q = \left\{ \sum_{j=0}^q t_j P_j \mid \sum_{j=0}^q t_j = 1 \right\}.$$

If X is a topological space, a *singular q -simplex* in X is a continuous map $s: \Delta_q \rightarrow X$ and a *singular q -chain* in X is a finite linear combination with integer coefficients of singular q -simplices. Collectively these q -chains form an Abelian group $S_q(X)$. We define the *l -th face map* of the standard q -simplex to be the function

$$\partial_q^l: \Delta_{q-1} \rightarrow \Delta_q$$

given by (see Figure 15.1)

$$\partial_q^l \left(\sum_{j=0}^{q-1} t_j P_j \right) = \sum_{j=0}^{l-1} t_j P_j + \sum_{j=l+1}^q t_j P_j.$$

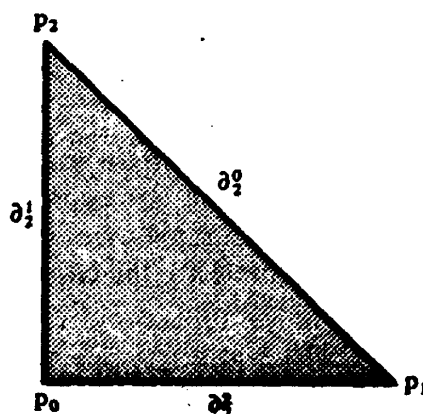

Figure 15.1

The graded group of singular chains,

$$S_*(X) = \bigoplus_{q \geq 0} S_q(X)$$

can be made into a differential complex with boundary operator

$$\begin{aligned} \partial: S_q(X) &\rightarrow S_{q-1}(X) \\ \partial s &= \sum_{i=0}^q (-1)^i s \circ \partial_i^t. \end{aligned}$$

It is easily checked that $\partial^2 = 0$. The homology of this complex is the *singular homology with integer coefficients* of X , denoted $H_*(X)$ or $H_*(X; \mathbb{Z})$. By taking the linear combination of simplices to be with coefficients in an Abelian group G , we obtain similarly *singular homology with coefficients in G* , $H_*(X; G)$.

The *degree* of a 0-chain $\sum n_i P_i$ is by definition $\sum n_i$. Suppose X is path connected. If $-P$ and Q are in a 0-chain on X , then any path from P to Q is a 1-simplex with boundary $Q - P$. Hence a 0-chain on a path-connected space is the boundary of a 1-chain if and only if it has degree 0. This gives rise to a short exact sequence

$$0 \rightarrow \partial S_1(X) \rightarrow S_0(X) \xrightarrow{\text{deg}} \mathbb{Z} \rightarrow 0,$$

from which it follows that if X is path connected, $H_0(X) = \mathbb{Z}$. In general,

$$\dim H_0(X) = \text{the number of path components of } X.$$

The Cone Construction

The goal of this section is to compute the singular homology of \mathbb{R}^n . If s in $S_q(\mathbb{R}^n)$ is a q -simplex in \mathbb{R}^n , we define the *cone* over s to be the $(q+1)$ -simplex Ks in $S_{q+1}(\mathbb{R}^n)$ given by

$$Ks \left(\sum_{j=0}^{q+1} t_j P_j \right) = (1 - t_{q+1}) s \left(\sum_{j=0}^q \frac{t_j}{1 - t_{q+1}} P_j \right).$$

This is the cone in \mathbb{R}^n with vertex the origin and base the simplex s . To make sense of the formula, we view the last coordinate t_{q+1} as "time"; as time goes from 0 to 1, the cone Ks moves from s to the origin. For the singular simplex s pictured in Figure 15.2, the cone Ks is the "tetrahedron" and

$$\partial Ks = 0\text{th face} - 1\text{st face} + 2\text{nd face} - s$$

$$K\partial s = 0\text{th face} - 1\text{st face} + 2\text{nd face}.$$

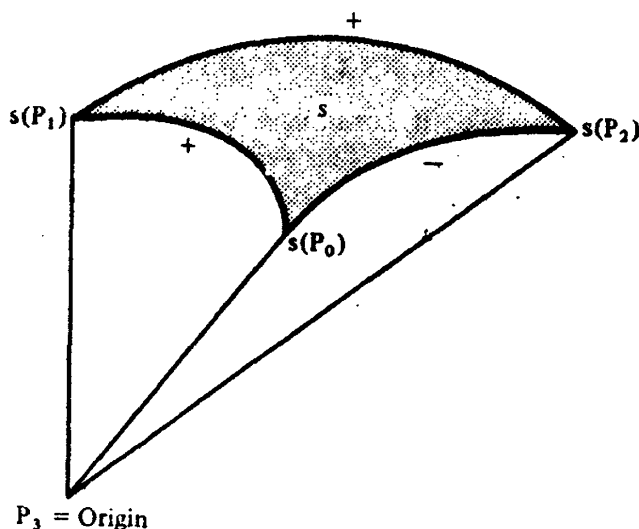

Figure 15.2

In general we have the following.

Proposition 15.1. *Let $K: S_*(\mathbb{R}^n) \rightarrow S_{*+1}(\mathbb{R}^n)$ be the cone construction. Then*

$$\partial K - K\partial = (-1)^{q+1}$$

on $S_q(\mathbb{R}^n)$ for $q \geq 1$.

PROOF. The geometrical idea is clear from Figure 15.2. The proof itself is a routine matter of unravelling the definitions. We leave it to the reader. \square

In other words, the cone construction K is a homotopy operator between the identity map and the zero map on $S_q(\mathbb{R}^n)$, $q \geq 1$. Consequently,

$$H_q(\mathbb{R}^n) = \begin{cases} 0 & q \geq 1 \\ \mathbb{Z} & q = 0. \end{cases}$$

The Mayer-Vietoris Sequence for Singular Chains

Let $\mathcal{U} = \{U_\alpha\}_{\alpha \in J}$ be an open cover of the topological space X . Just as for differential forms on a manifold, the sequence of inclusions

$$X \leftarrow \coprod_{\alpha_0} U_{\alpha_0} \rightrightarrows \coprod_{\alpha_0 < \alpha_1} U_{\alpha_0 \alpha_1} \rightrightarrows \dots$$

induces a Mayer-Vietoris sequence. However, for technical reasons which will become apparent in the proof of Proposition 15.2 (to show the surjectivity at one end of the Mayer-Vietoris sequence), we must consider here the group $S_*^{\mathcal{U}}(X)$ of \mathcal{U} -small chains in X ; these are chains made up of simplices

each of which lies in some open set of the cover \mathcal{U} . The inclusion

$$i: S_*^{\mathcal{U}}(X) \rightarrow S_*(X)$$

is clearly a chain map, i.e., it commutes with the boundary operator ∂ . Indeed, it is a chain equivalence. The proof of this fact is tedious and we will omit it (Vick [1, Appendix I, p. 207]), but the idea behind it is quite intuitive: to get an inverse chain map, subdivide each chain in X until it becomes \mathcal{U} -small. In any case the upshot is that to compute the singular cohomology of X it suffices to use \mathcal{U} -small chains: $H(S_*(X)) = H(S_*^{\mathcal{U}}(X))$.

Define the Čech boundary operator

$$\delta: \bigoplus_{\alpha_0 < \dots < \alpha_p} S_q(U_{\alpha_0 \dots \alpha_p}) \rightarrow \bigoplus_{\alpha_0 < \dots < \alpha_{p-1}} S_q(U_{\alpha_0 \dots \alpha_{p-1}})$$

by the "alternating sum formula"

$$(\delta c)_{\alpha_0 \dots \alpha_{p-1}} = \sum_{\alpha} c_{\alpha \alpha_0 \dots \alpha_{p-1}}$$

Here, as always, we adopt the convention that interchanging two indices in $c_{\alpha_0 \dots \alpha_p}$ introduces a minus sign. The fact that $\delta^2 = 0$ is proved as in Proposition 12.12. The boundary operator δ on $\bigoplus S_q(U_{\alpha_0}) \rightarrow S_q(X)$ is simply the sum; we denote this by ε .

Proposition 15.2 (The Mayer-Vietoris Sequence for Singular Chains). *The following sequence is exact*

$$0 \leftarrow S_q^{\mathcal{U}}(X) \xleftarrow{\varepsilon} \bigoplus_{\alpha_0} S_q(U_{\alpha_0}) \xleftarrow{\delta} \bigoplus_{\alpha_0 < \alpha_1} S_q(U_{\alpha_0 \alpha_1}) \xleftarrow{\delta} \dots$$

Although this sequence bears a formal resemblance to the generalized Mayer-Vietoris sequence for compact supports (Proposition 12.12), because we do not have partitions of unity at our disposal now, the second half of the proof of (12.12) does not apply.

Lemma 15.3. *Let*

$$0 \rightarrow A \rightarrow B \rightarrow C \rightarrow 0$$

be a short exact sequence of differential complexes. If two out of the three complexes have zero homology, so does the third.

PROOF. Consider the long exact sequence in homology

$$\dots \rightarrow H_q(A) \rightarrow H_q(B) \rightarrow H_q(C) \rightarrow H_{q-1}(A) \rightarrow \dots \quad \square$$

PROOF OF PROPOSITION 15.2. For two open sets the Mayer-Vietoris sequence is

$$0 \leftarrow S_q^{\mathcal{U}}(U_0 \cup U_1) \xleftarrow{\text{sum}} S_q(U_0) \oplus S_q(U_1) \xleftarrow{\varepsilon} S_q(U_{01}) \leftarrow 0$$

$$(c_{10}, c_{01}) \longleftarrow c_{01}$$

The exactness of this sequence follows directly from the definition. For three open sets the sequence is

$$\begin{array}{ccccccc}
 0 \leftarrow S^q(U_0 \cup U_1 \cup U_2) \leftarrow S^q(U_0) \oplus S^q(U_1) \oplus S^q(U_2) & \longleftarrow & S^q(U_{01}) \oplus S^q(U_{02}) \oplus S^q(U_{12}) & \leftarrow & S^q(U_{012}) & \leftarrow & 0 \\
 & & (c_{10} + c_{20}, c_{01} + c_{21}, c_{02} + c_{12}) & & (c_{01}, c_{02}, c_{12}) & & \\
 & & & & (c_{201}, c_{102}, c_{012}) & & \longleftarrow & c_{012}
 \end{array}$$

The Mayer-Vietoris sequence for two open sets injects into the one for three open sets, giving rise to the following commutative diagram with exact columns

$$\begin{array}{ccccccc}
 & 0 & & 0 & & 0 & \\
 & \downarrow & & \downarrow & & \downarrow & \\
 0 \leftarrow S^q(U_0 \cup U_1) & \longleftarrow & S^q(U_0) \oplus S^q(U_1) & \longleftarrow & S^q(U_{01}) & \longleftarrow & 0 \\
 & \downarrow & & \downarrow & & \downarrow & \\
 0 \leftarrow S^q(U_0 \cup U_1 \cup U_2) & \longleftarrow & S^q(U_0) \oplus S^q(U_1) \oplus S^q(U_2) & \longleftarrow & S^q(U_{01}) \oplus S^q(U_{02}) \oplus S^q(U_{12}) & \longleftarrow & S^q(U_{012}) \leftarrow 0 \\
 & \downarrow & & \downarrow & & \downarrow & \\
 0 \leftarrow \frac{S^q(U_0 \cup U_1 \cup U_2)}{S^q(U_0 \cup U_1)} & \xrightarrow{\beta} & S^q(U_2) & \xrightarrow{\beta} & S^q(U_{02}) \oplus S^q(U_{12}) & \longleftarrow & S^q(U_{012}) \leftarrow 0 \\
 & \downarrow & & \downarrow & & \downarrow & \\
 & 0 & & 0 & & 0 & \\
 & & & & & & 0
 \end{array}$$

The \mathcal{U} in $S^q(U_0 \cup U_1)$ is the open cover $\{U_0, U_1\}$, while the \mathcal{U} in $S^q(U_0 \cup U_1 \cup U_2)$ is the open cover $\{U_0, U_1, U_2\}$. So the group

$$S^q(U_0 \cup U_1 \cup U_2) / S^q(U_0 \cup U_1)$$

is generated by the simplices in U_2 which do not lie entirely in U_0 or U_1 (see Figure 15.3).

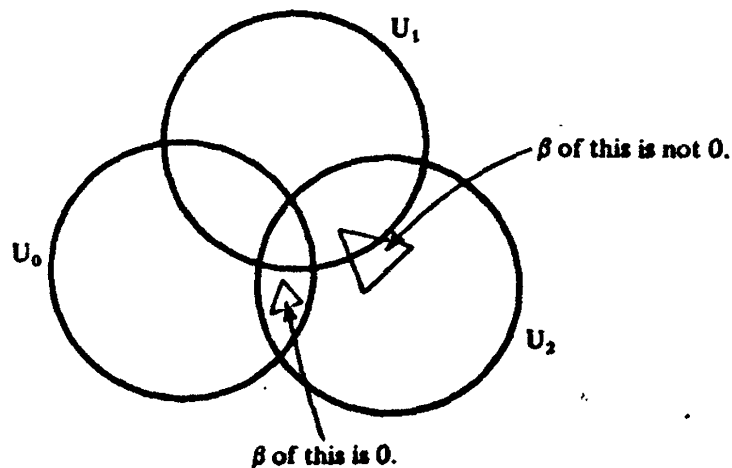

Figure 15.3

We now prove the exactness of the rows of the commutative diagram. The bottom row is almost the Mayer-Vietoris sequence for the open cover $\{U_{02}, U_{12}\}$; it is exact except possibly at $S(U_2)$. Clearly $\beta \circ \delta = 0$. Now if c is in $S(U_2)$ and $\beta(c) = 0$, then c is a chain in U_2 whose simplices lie either in U_0 or in U_1 , i.e., c is in the image of $S(U_{02}) \oplus S(U_{12})$. Therefore the bottom row is exact. Note that each row of the commutative diagram is a differential complex and the commutative diagram may be regarded as a short exact sequence of differential complexes. Since the top and bottom complexes have zero cohomology, by Lemma 15.3 so does the middle one; in other words, the middle row is exact. This proves the exactness of the Mayer-Vietoris sequence for a cover consisting of three open sets. In general the Mayer-Vietoris sequence for r open sets injects into the one for $r + 1$ open sets. By the above technique and induction, one proves the Mayer-Vietoris sequence for any finite cover.

Now consider a countable cover $\mathcal{U} = \{U_\alpha\}$. By the definition of the direct sum, an element c of $\bigoplus S(U_{\alpha_0 \dots \alpha_p})$ has only finitely many nonzero components. These components can involve only finitely many open sets. Therefore if $\delta c = 0$, by the Mayer-Vietoris sequence for a finite cover, we know that $c = \delta b$ for some b in $\bigoplus S(U_{\alpha_0 \dots \alpha_{p+1}})$. This proves the exactness of the Mayer-Vietoris sequence for countably many open sets. \square

REMARK 15.4. If the coefficients are in an arbitrary Abelian group G , the same proof holds word for word.

Now suppose the open cover \mathcal{U} consists of two open sets U and V . By Proposition 15.2, there is a short exact sequence of singular chains

$$(15.5) \quad 0 \rightarrow S_q(U \cap V) \rightarrow S_q(U) \oplus S_q(V) \rightarrow S_q^{\mathcal{U}}(X) \rightarrow 0.$$

The associated long exact sequence in homology is the usual homology Mayer-Vietoris sequence.

Corollary 15.6 (The Homology Mayer-Vietoris Sequence for Two Open Sets). *Let $X = U \cup V$ be the union of two open sets. Then there is a long exact sequence in homology*

$$\cdots \rightarrow H_q(U \cap V) \xrightarrow{f} H_q(U) \oplus H_q(V) \xrightarrow{g} H_q(X) \rightarrow H_{q-1}(U \cap V) \rightarrow \cdots$$

Here f is the map induced by the signed inclusion $a \mapsto (-a, a)$ and g is the sum $(a, b) \mapsto a + b$.

Singular Cohomology

A singular q -cochain on a topological space X is a linear functional on the \mathbb{Z} -module $S_q(X)$ of singular q -chains. Thus the group of singular q -cochains is $S^q(X) = \text{Hom}(S_q(X), \mathbb{Z})$. With the coboundary operator d defined by

$(d\omega)(c) = \omega(\partial c)$, the graded group of singular cochains $S^*(X) = \bigoplus S^q(X)$ becomes a differential complex; the homology of this complex is the *singular cohomology of X with integer coefficients*. Replacing \mathbb{Z} with an Abelian group G we obtain the singular cohomology with coefficients in G , denote $H^*(X; G)$. For the rest of this chapter we will reserve $H^*(X)$ for the singular cohomology with integer coefficients and write $H_{DR}^*(X)$ for the de Rham cohomology.

A function ω on X is a 0-cocycle if and only if $\omega(\partial c) = 0$ for all paths c in X . It follows that such an ω is constant on each path component of X . Therefore, $H^0(X) = S^0(X) = \mathbb{Z} \oplus \mathbb{Z} \oplus \cdots \oplus \mathbb{Z}$ where there are as many copies of \mathbb{Z} as there are path components of X .

REMARK. The singular cohomology does not always agree with the Čech cohomology. For instance,

$$\dim H_{\text{sing}}^0(X) = \# \text{ path components of } X,$$

but

$$\dim H_{\text{Čech}}^0(X) = \# \text{ connected components of } X.$$

We now compute the singular cohomology of \mathbb{R}^n . Define the operator $L: S^q(\mathbb{R}^n) \rightarrow S^{q-1}(\mathbb{R}^n)$ to be the adjoint of the cone construction K : if $\sigma \in S^q(\mathbb{R}^n)$ and $c \in S_{q-1}(\mathbb{R}^n)$,

$$(L\sigma)(c) = \sigma(Kc).$$

Then for $\sigma \in S^q(\mathbb{R}^n)$ and $c \in S_q(\mathbb{R}^n)$,

$$\begin{aligned} ((dL - Ld)\sigma)(c) &= (d(L\sigma))(c) - (L(d\sigma))(c) \\ &= (L\sigma)(\partial c) - (d\sigma)(Kc) \\ &= \sigma(K\partial c) - \sigma(\partial Kc) \\ &= \sigma((K\partial - \partial K)c) \\ &= ((-1)^{q+1}\sigma)(c) \text{ by Proposition 15.1.} \end{aligned}$$

Hence

$$1 = (-1)^{q+1}(dL - Ld) \text{ on } S^q(\mathbb{R}^n), \quad q \geq 1,$$

i.e., L is a homotopy operator between the identity map and the zero map on the q -cochains, $q \geq 1$. It follows that

$$H^q(\mathbb{R}^n) = \begin{cases} \mathbb{Z}, & q = 0 \\ 0, & q > 0. \end{cases}$$

Applying the functor $\text{Hom}(\cdot, \mathbb{Z})$ to the Mayer-Vietoris sequence for singular chains we obtain the *Mayer-Vietoris sequence for singular cochains*

$$(15.7) \quad 0 \rightarrow S_{\text{II}}^*(X) \xrightarrow{\iota^*} \bigoplus S^*(U_{\alpha_i}) \xrightarrow{\delta^*} \bigoplus_{\alpha_i < \alpha_j} S^*(U_{\alpha_i \alpha_j}) \xrightarrow{\delta^*} \dots$$

Since the functor $\text{Hom}(_, Z)$ preserves the exactness of a sequence of free Z -modules (see Exercise 14.17.3), the Mayer-Vietoris sequence for singular cochains is exact.

Exercise 15.7.1. Show that ε^* is the restriction map and δ^* is the alternating difference

$$(\delta^*\omega)_{a_0 \dots a_{p+1}} = \sum_{i=0}^{p+1} (-1)^i \omega_{a_0 \dots \hat{a}_i \dots a_{p+1}}$$

Once we have the Mayer-Vietoris sequence we can set up the double complex $C^*(\mathcal{U}, S^*)$. Just as in the de Rham theory the double complex $C^*(\mathcal{U}, S^*)$ computes the singular cohomology of X . This is because by the exactness of the Mayer-Vietoris sequence, H_δ of this complex has a single zero column

$$H_\delta = \begin{array}{ccc} & \uparrow & \\ & S^2(X) & 0 \\ & \uparrow & \\ & S^1(X) & 0 \\ & \uparrow & \\ & S^0(X) & 0 \\ 0 & & 1 \end{array}$$

so that the spectral sequence degenerates at the E_2 term and

$$H\{C^*(\mathcal{U}, S^*)\} = H_\delta H_\delta \cong H^*(X).$$

To complete the analogy we will need the existence of a good cover on the topological space X . This presents no problem if X admits a triangulation, i.e., a homeomorphism with the support of a simplicial complex, since the open star of the triangulation is a good cover. By taking barycentric subdivisions of the triangulation we can refine its star ad infinitum. Hence just as in the case of manifolds, *the good covers on a triangularizable space X are cofinal in the set of all covers of X .* We note in passing that this gives an alternative proof of the existence of a good cover on a manifold since it is known that every manifold admits a triangulation (due to Cairns and Whitney, see Whitney [2, pp. 124–135]).

If \mathcal{U} is a good cover of a topological space X , then H_d of the double complex $C^*(\mathcal{U}, S^*)$ is

0	0	0
$C^0(\mathcal{U}, \mathbb{Z})$	$C^1(\mathcal{U}, \mathbb{Z})$	$C^2(\mathcal{U}, \mathbb{Z})$

and $H_d H_d = H^*(\mathcal{U}, \mathbb{Z}) = H\{C^*(\mathcal{U}, S^*)\}$. So there is an isomorphism between the singular cohomology and the Čech cohomology of a good cover with coefficients in the constant presheaf \mathbb{Z} :

$$H^*(X) \simeq H^*(\mathcal{U}, \mathbb{Z}).$$

Suppose X triangularizable. Since the good covers are cofinal in the set of all covers of X ,

$$H^*(X, \mathbb{Z}) = H^*(\mathcal{U}, \mathbb{Z})$$

where $H^*(X, \mathbb{Z})$ is the Čech cohomology of X with coefficients in the constant presheaf \mathbb{Z} . Therefore,

Theorem 15.8. *The singular cohomology of a triangularizable space X is isomorphic to its Čech cohomology with coefficients in the constant presheaf \mathbb{Z} . If \mathcal{U} is a good cover of X , then*

$$H^*(X) \simeq H^*(X, \mathbb{Z}) \simeq H^*(\mathcal{U}, \mathbb{Z}).$$

Let $\pi : E \rightarrow X$ be a fiber bundle with fiber F over a triangularizable topological space X . Just as in Theorem 14.18, from the double complex $C(\pi^{-1}\mathcal{U}, S^*)$ on E we obtain a spectral sequence converging to the singular cohomology $H^*(E)$ whose E_2 term is

$$E_2^{p,q} = H^p(\mathcal{U}, \mathcal{K}^q(F)),$$

where $\mathcal{K}^q(F)$ is the locally constant presheaf $\mathcal{K}^q(U) = H^q(\pi^{-1}U)$. If $\mathcal{K}^q(F)$ happens to be the constant presheaf $\mathbb{Z} \oplus \dots \oplus \mathbb{Z}$ on \mathcal{U} , then

$$E_2^{p,q} = \underbrace{H^p(\mathcal{U}, \mathbb{Z}) \oplus \dots \oplus H^p(\mathcal{U}, \mathbb{Z})}_{\dim H^q(F) \text{ terms}} = H^p(X) \oplus \dots \oplus H^p(X) = H^p(X) \otimes H^q(F).$$

The singular cohomology group $H^*(X; \mathbb{Z})$ can be given a product structure as follows. If $(A_0 \dots A_q)$ is a q -simplex in X , we say that $(A_0 \dots A_r)$ is its

front r -face and $(A_{q-r} \dots A_q)$ its back r -face. Let ω be a p -cochain and η a q -cochain; by definition their cup product is given by

$$(15.9) \quad (\omega \cup \eta)(A_0 \dots A_{p+q}) = \omega(A_0 \dots A_p) \eta(A_{p+1} \dots A_{p+q}).$$

Exercise 15.10. Show that the coboundary operator d is an antiderivation relative to the cup product:

$$d(\omega \cup \eta) = (d\omega) \cup \eta + (-1)^{\deg \omega} \omega \cup d\eta.$$

By arguments analogous to (15.2) and (15.7) there is also a Mayer-Vietoris sequence for singular cochains with coefficients in a commutative ring A . Using the cup product (15.9) in place of the wedge product, the spectral sequence of the Čech-singular complex $C^*(\mathcal{U}, S^*)$ can be given a product structure just as in (14.24). The arguments in Section 14 carry over mutatis mutandis. Hence the results on spectral sequences remain true for singular cohomology with coefficients in A . Note however in (14.18) and (14.30) the E_2 term of a fiber bundle $\pi: E \rightarrow M$ with fiber F over a simply connected base space M is the tensor product $H^*(M; A) \otimes H^*(F; A)$ only if the cohomology of F is a free A -module. In summary we have the following.

Theorem 15.11 (Leray's Theorem for Singular Cohomology with Coefficients in a Commutative Ring A). *Let $\pi: E \rightarrow X$ be a fiber bundle with fiber F over a topological space X and \mathcal{U} an open cover of X . Then there is a spectral sequence converging to $H^*(E; A)$ with E_2 term*

$$E_2^{p,q} = H^p(\mathcal{U}, \mathcal{H}^q(F; A)).$$

Each E_r in the spectral sequence can be given a product structure relative to which the differential d_r is an antiderivation. If X is simply connected and has a good cover, then

$$E_2^{p,q} = H^p(X, H^q(F; A)).$$

If in addition $H^(F; A)$ is a finitely generated free A -module, then*

$$E_2 = H^*(X; A) \otimes H^*(F; A)$$

algebras over A .

Exercise 15.12 (Künneth Formula for Singular Cohomology). *If X is a space having a good cover, e.g., a triangularizable space, and Y is any topological space, prove using the spectral sequence of the fiber bundle $\pi: X \times Y \rightarrow X$ that*

$$H^*(X \times Y) = \bigoplus_{p+q=*} H^p(X, H^q(Y)).$$

We examine briefly here how some of the theorems in de Rham theory carry over to the singular theory. Both the Mayer-Vietoris argument of Section 5 and the tic-tac-toe proof of Section 9 for the Leray-Hirsch theorem go through for integer coefficients, with the singular complex $C^*(U, S^*)$ in place of $C^*(U, \Omega^*)$. However, since there may be torsion in $H^*(F)$, the Künneth formula in the form $H^*(M \times F) = H^*(M) \otimes H^*(F)$ is not true with integer coefficients; the Mayer-Vietoris argument fails because tensoring with $H^*(F)$ need not preserve exactness, and the tic-tac-toe proof fails because $H^*(F) \otimes C^*(U, S^*)$ may not be simply a finite number of copies of $C^*(U, S^*)$. These difficulties do not arise in the case of the Leray-Hirsch theorem, since in its hypothesis the cohomology of the fiber $H^*(F)$ is assumed to be a free \mathbb{Z} -module.

REMARK 15.13. Given any Abelian group A , let F be the free Abelian group generated by a set of generators for A and let R be the kernel of the natural map $p: F \rightarrow A$. Then

$$(15.13.1) \quad 0 \rightarrow R \xrightarrow{i} F \xrightarrow{p} A \rightarrow 0$$

is a short exact sequence of Abelian groups. As a subgroup of a free group, R is also free (Jacobson [1, §3.6]). An exact sequence such as (15.13.1), in which F and R are free, is called a *free resolution* of A . Let G be an Abelian group. By Exercise 14.17.4, the two sequences

$$(15.13.2) \quad 0 \rightarrow \text{Hom}(A, G) \rightarrow \text{Hom}(F, G) \xrightarrow{p^*} \text{Hom}(R, G)$$

and

$$(15.13.3) \quad R \otimes G \xrightarrow{i \otimes 1} F \otimes G \longrightarrow A \otimes G \longrightarrow 0$$

are exact.

Definition.

$$\text{Ext}(A, G) = \text{coker } i^* = \text{Hom}(R, G) / \text{im } i^*.$$

$$\text{Tor}(A, G) = \ker i \otimes 1.$$

Thus Ext and Tor measure the failure of the two exact sequences (15.13.2) and (15.13.3) to be short exact. It is not hard to show that the definition of Ext and Tor is independent of the choice of the free resolution. For the elementary properties of these two functors see, for instance, Switzer [1, Chap. 13].

Exercise 15.13.4. If m and n are positive integers, we denote their greatest

common divisor by (m, n) . Verify the tables

Ext	\mathbb{Z}	\mathbb{Z}_n
\mathbb{Z}	0	0
\mathbb{Z}_m	\mathbb{Z}_m	$\mathbb{Z}_{(m, n)}$

Tor	\mathbb{Z}	
\mathbb{Z}	0	0
\mathbb{Z}_m	0	$\mathbb{Z}_{(m, n)}$

For example,

$$\text{Ext}(\mathbb{Z}_m, \mathbb{Z}) = \mathbb{Z}_m.$$

In terms of these completely algebraic functors, one finds the following description of the dependence of the singular theory on its coefficient group. For a proof see Spanier [1, pp. 222 and 243].

Theorem 15.14 (Universal Coefficient Theorems). *For any space X and Abelian group G ,*

(a) *the homology of X with coefficients in G has a splitting:*

$$H_q(X; G) \simeq H_q(X) \otimes G \oplus \text{Tor}(H_{q-1}(X), G);$$

(b) *the cohomology of X with coefficients in G also has a splitting:*

$$H^q(X; G) \simeq \text{Hom}(H_q(X), G) \oplus \text{Ext}(H_{q-1}(X), G).$$

Applying Part (b) with $G = \mathbb{Z}$ yields the following formula for the integer cohomology in terms of the integer homology.

Corollary 15.14.1. *For any space X for which $H_q(X)$ and $H_{q-1}(X)$ are finitely generated \mathbb{Z} -modules,*

$$H^q(X) \simeq F_q \oplus T_{q-1},$$

where F_q is the free part of $H_q(X)$ and T_{q-1} is the torsion part of $H_{q-1}(X)$.

REMARK. The splittings given by the universal coefficient theorems cannot be arranged to be compatible with the induced homomorphisms of maps. They are therefore often said to be *unnatural* splittings.

EXAMPLE 15.15 (The cohomology of the unit tangent bundle of a sphere). The unit tangent bundle $S(T_{S^2})$ to the 2-sphere in \mathbb{R}^3 is a fiber bundle with fiber S^1 :

$$\begin{array}{ccc} S^1 & \rightarrow & S(T_{S^2}) \\ & & \downarrow \\ & & S^2. \end{array}$$

By (15.11) the E_2 term of the spectral sequence is

$$E_2^{p,q} = H^p(S^2) \otimes H^q(S^1)$$

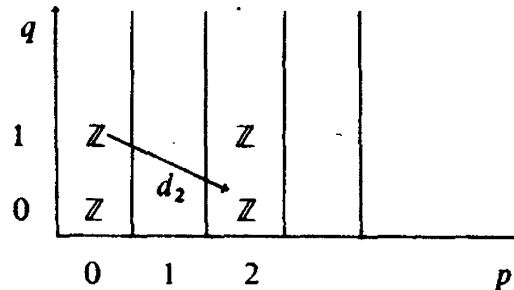

For dimensional reasons $d_3 = d_4 = \dots = 0$, so $E_3 = E_\infty$. By Remark 14.20 the differential d_2 in the diagram defines the Euler class of the circle bundle $S(T_{S^2})$. Since the Euler class of $S(T_{S^2})$ is twice the generator of $H^2(S^2)$ (Example 11.18), this d_2 is multiplication by 2. Thus

$$H^*S(T_{S^2}) = \begin{cases} \mathbb{Z} & \text{in dimensions 0 and 3} \\ \mathbb{Z}_2 & \text{in dimension 2} \\ 0 & \text{otherwise.} \end{cases}$$

Exercise 15.15.1. Compute the cohomology of the unit tangent bundle $S(T_{S^2})$.

A point in $S(T_{S^2})$ is specified by a unit vector in \mathbb{R}^3 and another unit vector orthogonal to it. This can be completed to a unique orthonormal basis with positive determinant. Therefore $S(T_{S^2}) \simeq SO(3)$ and we have computed above the cohomology of $SO(3)$.

REMARK 15.15.2. The special orthogonal group $SO(3)$ comes in a different guise as $\mathbb{R}P^3$, as follows. We can think of $SO(3)$ as the group of all rotations about the origin in \mathbb{R}^3 . Each such rotation is determined by its axis and an angle $-\pi \leq \theta \leq \pi$. In this way $SO(3)$ is parametrized by the solid 3-ball D^3 of radius π in \mathbb{R}^3 : a point in this 3-ball determines a unique axis and a unique angle of rotation, the axis being the line through the point and the origin, and the angle being the distance of the point from the origin. Since rotating through the angle $-\pi$ has the same effect as through π , any pair of antipodal points on the boundary of D^3 parametrize the same rotation. So $SO(3)$ is homeomorphic to $\mathbb{R}P^3$.

Exercise 15.16 (The Cohomology of $SO(4)$). The special orthogonal group $SO(n)$ acts transitively on the unit sphere S^{n-1} in \mathbb{R}^n with stabilizer $SO(n-1)$. Therefore $SO(n)/SO(n-1) \simeq S^{n-1}$. A group with a differentiable

structure relative to which the group operations, namely multiplication and inverse, are smooth is called a *Lie group*. $GL(n, \mathbb{R})$ and $SO(n)$ are examples of Lie groups (see Spivak [1, Ex. 33, p. 83]). It is a fact from the theory of Lie groups that if H is a closed subgroup of a Lie group G , i.e., H is a Lie subgroup and a closed subset of G , then $\pi: G \rightarrow G/H$ is a fiber bundle with fiber H (Warner [1, Th. 3.58, p. 120]). Apply the spectral sequence of the fiber bundle

$$\begin{array}{c} SO(3) \rightarrow SO(4) \\ \downarrow \\ S^3 \end{array}$$

to compute the cohomology of $SO(4)$.

Exercise 15.17 (The Cohomology of the Unitary Group). The unitary group $U(n)$ acts transitively on the unit sphere S^{2n-1} in \mathbb{C}^n with stabilizer $U(n-1)$. Hence $U(n)/U(n-1) = S^{2n-1}$. Apply the spectral sequence of the fiber bundle

$$\begin{array}{c} U(n-1) \rightarrow U(n) \\ \downarrow \\ S^{2n-1} \end{array}$$

to compute the cohomology of $U(n)$.

The Homology Spectral Sequence

Although in this book we are primarily concerned with cohomology, for applications to homotopy theory it is frequently advantageous to use the homology spectral sequence of a fibering. Since the construction of such a spectral sequence is analogous to that for cohomology, the discussion will be brief.

Using the singular chain functor S_* in place of the differential form functor Ω^* we get a double complex $C_*(U, S_*)$ with differential operators ∂ and δ . Define D to be $\delta + (-1)^p \partial$.

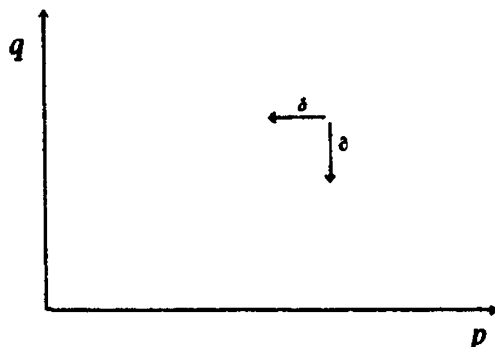

As in Section 14 this double complex gives rise to a spectral sequence $\{E^r\}$ which converges to the total homology $H_D\{C_*(\mathcal{U}, S_*)\}$. Because of the directions of the arrows ∂ and δ , the differential d^r goes in the opposite direction as the differential of a cohomology spectral sequence; more precisely,

$$d^r : E_{p,q}^r \rightarrow E_{p-r, q+r-1}^r.$$

By the exactness of the Mayer-Vietoris sequence (15.2) the spectral sequence is degenerate at the E^2 term and

$$E^2 = H_0 H_1 = H_*(X).$$

Hence we have the following.

Proposition 15.18. *For any cover \mathcal{U} of X the double complex $C_*(\mathcal{U}, S_*)$ computes the singular homology of X :*

$$H_D\{C_*(\mathcal{U}, S_*)\} = H_*(X).$$

To avoid confusion with the cohomology spectral sequence, we write r as a superscript and p and q as subscripts in the homology spectral sequence: $E_{p,q}^r$.

Now suppose \mathcal{U} is a good cover of X . Interchanging the roles of ∂ and δ gives another spectral sequence which also converges to $H_D\{C_*(\mathcal{U}, S_*)\}$. This time

$$(15.19) \quad E^\infty = E^2 = H_1 H_0 = H_*(\mathcal{U}, Z)$$

where Z is the constant presheaf with group Z . Comparing (15.18) with (15.19) gives the isomorphism of the singular homology to the Čech homology $H_*(\mathcal{U}, Z)$ of a good cover. Along the line of Theorem 14.18, if $\pi : E \rightarrow X$ is a fiber bundle with fiber F , and X is a simply connected space with a good cover, then there is a spectral sequence converging to the singular homology $H_*(E)$ with $E_{p,q}^2 = H_p(X, H_q(F))$. If in addition $H_q(F)$ is a free Z -module, the E^2 term is isomorphic to the tensor product $H_p(X) \otimes H_q(F)$ as Z -modules. Unlike the cohomology spectral sequence, there is in general no product structure in homology.

§16 The Path Fibration

Recall again that through §18 we work in the category of topological spaces and continuous maps. Unless otherwise noted all cohomology groups will be assumed to have integer coefficients. Let $\pi : E \rightarrow X$ be a fiber bundle with fiber F over a topological space X that has a good cover \mathcal{U} . We have shown that there is a spectral sequence converging to the cohomology $H^*(E)$ of the total space, with E_2 term

$$E_2^{p,q} = H^p(\mathcal{U}, \mathcal{K}^q(F)),$$

where $\mathcal{H}^q(F)$ is the presheaf that associates to every open set U in \mathcal{U} the group $H^q(\pi^{-1}U) \simeq H^q(F)$. Now suppose $\pi : E \rightarrow X$ is simply a map, not necessarily locally trivial. One can still obtain a spectral sequence by considering the double complex of singular cochains $K = C^*(\pi^{-1}\mathcal{U}, S^*)$ on E . As long as the map $\pi : E \rightarrow X$ has the property that

$$(16.1) \quad H^q(\pi^{-1}U) \simeq H^q(F) \text{ for some fixed space } F \text{ and for any contractible open set } U,$$

then $E_2 = H_\delta H_d(K)$ will be the same as for a fiber bundle. Since the spectral sequence is a purely algebraic way of going from $H_\delta H_d$ to H_D , which is isomorphic to $H^*(E)$, the spectral sequence of this double complex will again converge to $H^*(E)$. An example of such a map is the *path fibration*. As will be seen in the next few sections, Serre's application of the spectral sequence in this unexpected setting has far-reaching consequences in homotopy theory.

The Path Fibration

Let X be a topological space with a base point $*$ and $[0, 1]$ the unit interval with base point 0. The *path space* of X is defined to be the space $P(X)$ consisting of all the paths in X with initial point $*$:

$$P(X) = \{\text{maps } \mu : [0, 1] \rightarrow X \mid \mu(0) = *\}.$$

We give this space the *compact open topology*; i.e., a basic open set in $P(X)$ consists of all base-point preserving maps $\mu : [0, 1] \rightarrow X$ such that $\mu(K) \subset U$ for a fixed compact set K in $[0, 1]$ and a fixed open set U in X . There is a natural projection $\pi : P(X) \rightarrow X$ given by the endpoint of a path: $\pi(\mu) = \mu(1)$. The fiber at p of this projection consists of all the path from $*$ to p (see Figure 16.1).

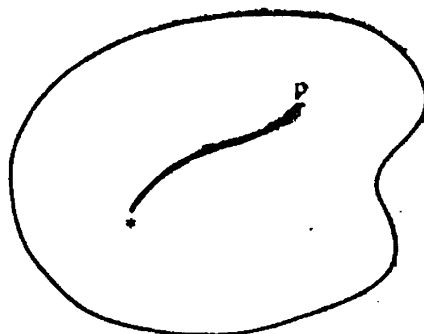

Figure 16.1

We now show that the map $\pi : P(X) \rightarrow X$ has the property (16.1). Let U be a contractible open set containing p . There is a natural inclusion

$$i : \pi^{-1}(p) \rightarrow \pi^{-1}(U).$$

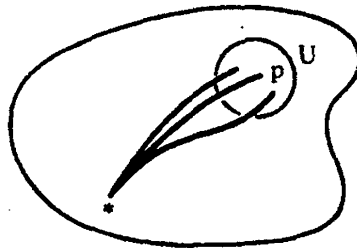

Figure 16.2

(See Figure 16.2.) Using a contraction of U to p , we can get a map

$$\phi : \pi^{-1}(U) \rightarrow \pi^{-1}(p).$$

It is readily checked that ϕ and i are homotopy inverses. Furthermore, if p and q are two points in the same path component of M , then a fixed path from p to q induces a homotopy equivalence $\pi^{-1}(p) \simeq \pi^{-1}(q)$. Thus all fibers have the homotopy type of $\pi^{-1}(*)$, which is the *loop space* ΩX of X :

$$\Omega X = \{ \mu : [0, 1] \rightarrow X \mid \mu(0) = \mu(1) = * \}.$$

So the map $\pi : P(X) \rightarrow X$ has the property $H^*(\pi^{-1}U) \simeq H^*(\Omega X)$ for any contractible U in X .

A more general class of maps satisfying (16.1) are the *fiberings* or *fibrations*. A map $\pi : E \rightarrow X$ is called a *fibering* or a *fibration* if it satisfies the *covering homotopy property*:

(16.2) given a map $f : Y \rightarrow E$ from any topological space Y into E and a homotopy \bar{f}_t of $\bar{f} = \pi \circ f$ in X , there is a homotopy f_t of f in E which covers \bar{f}_t ; that is, $\pi \circ f_t = \bar{f}_t$.

The covering homotopy property may be expressed in terms of the diagram

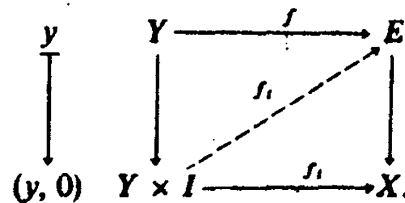

Such a fibering is sometimes called a *fibering in the sense of Hurewicz*, as opposed to a *fibering in the sense of Serre* which requires only that the covering homotopy property be satisfied for finite polyhedra Y . If X is a pointed space with base point $*$, we call $\pi^{-1}(*)$ the *fiber* of the fibering, and for any x in X , we call $F_x = \pi^{-1}(x)$ the *fiber over x* . As a convention we will assume the base space X of a fibering to be connected. It is clear that the map $\pi : PX \rightarrow X$ is a fibering with fiber ΩX , for a homotopy in X naturally induces a covering homotopy in PX . This fibering, called the *path fibration* of X , is fundamental in the computation of the cohomology of the loop spaces. Its total space PX can be contracted to the constant path: $[0, 1] \rightarrow *$.

We prove below two basic properties of a fibering, from which it will follow that (16.1) holds for a fibering.

Proposition 16.3.(a) *Any two fibers of a fibering over an arcwise-connected space have the same homotopy type.*

(b) *For every contractible open set U , the inverse image $\pi^{-1}U$ has the homotopy type of the fiber F_a , where a is any point in U .*

PROOF. (a) A path $\gamma(t)$ from a to b in X may be regarded as a homotopy of the point a . Let $\bar{g} : F_a \times I \rightarrow X$ be given by $(y, t) \mapsto \gamma(t)$, where I is the unit interval $[0, 1]$. So we have the situation depicted in Figure 16.3. By the

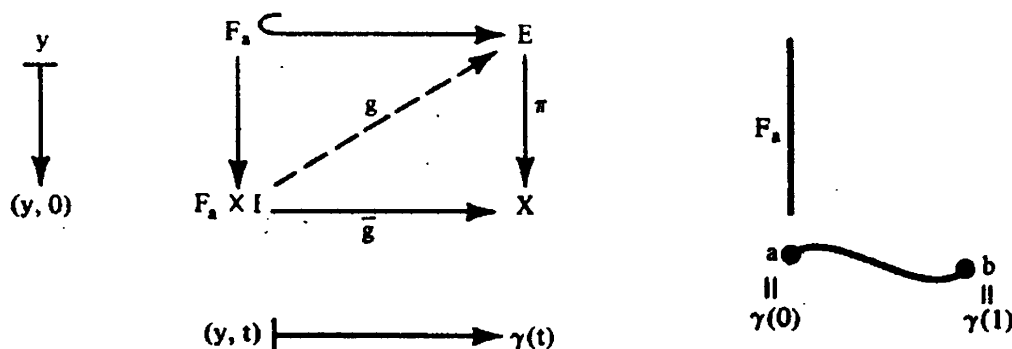

Figure 16.3

covering homotopy property, there is a map g which covers \bar{g} . The restriction $g_1 = g|_{F_a \times \{1\}}$ is then a map from F_a to F_b . Thus a path from a to b induces a map from the fiber F_a to the fiber F_b .

We will show that homotopic paths from a to b in X induce homotopic maps from F_a to F_b . Let μ be a path from a to b which is homotopic to γ , h a covering homotopy of μ , and h_1 the induced map from F_a to F_b . Define Z by (see Figure 16.4)

$$Z = F_a \times I \times \{0\} \cup F_a \times I \times I$$

and $f : Z \rightarrow E$ by

$$f|_{F_a \times I \times \{0\}}(y, s, 0) = y$$

$$f|_{F_a \times \{0\} \times I}(y, 0, t) = g(y, t)$$

$$f|_{F_a \times \{1\} \times I}(y, 1, t) = h(y, t).$$

We regard the homotopy between γ and μ in X as a homotopy \bar{G} of $\pi \circ f$.

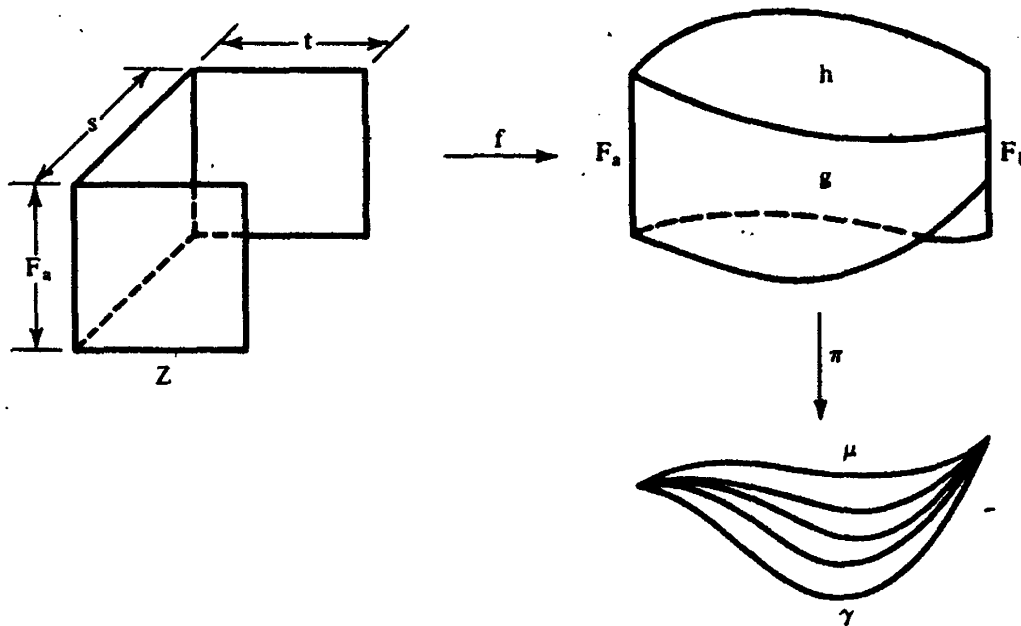
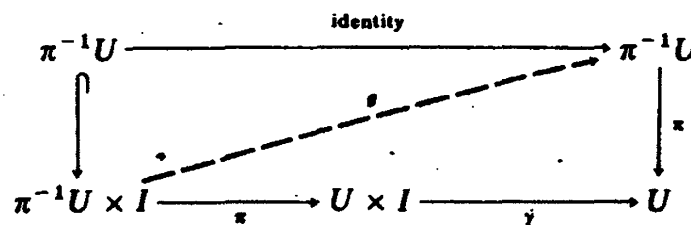

Figure 16.4

By the covering homotopy property there is a covering map G from $F_a \times I \times I$, which is homotopic to $Z \times I$, into E . The restriction of G to $F_a \times I \times \{1\}$ has image in F_b . Since $G|_{F_a \times \{0\} \times \{1\}} = g_1$ and $G|_{F_a \times \{1\} \times \{1\}} = h_1$, $G|_{F_a \times I \times \{1\}}$ is a homotopy in F_b between g_1 and h_1 .

Given two points a and b in X and a path γ from a to b , let $u: F_a \rightarrow F_b$ be a map induced by γ and $v: F_b \rightarrow F_a$ a map induced by γ^{-1} . Then $v \circ u: F_a \rightarrow F_a$ is a map induced by $\gamma^{-1}\gamma$. Since $\gamma^{-1}\gamma$ is homotopic to the constant map to a , the composition $v \circ u$ is homotopic to the identity on F_a . Therefore, F_a and F_b have the same homotopy type.

(b) Let $\gamma: U \times I \rightarrow U$ be a deformation retraction of U to the point a . By the covering homotopy property, there is a map $g: \pi^{-1}U \times I \rightarrow \pi^{-1}U$ such that the following diagram is commutative.



We will show that g gives a deformation retraction of $\pi^{-1}U$ onto the fiber F_a . Let g_t be the restriction of g to $\pi^{-1}U \times \{t\}$. By identifying $\pi^{-1}U$ with $\pi^{-1}U \times \{t\}$, we may regard g as a family of maps $g_t: \pi^{-1}U \rightarrow \pi^{-1}U$ vary-

ing with t in the unit interval I . At $t = 0$,

$$g_0: \pi^{-1}U \times \{0\} \rightarrow \pi^{-1}U$$

is the identity and at $t = 1$,

$$g_1: \pi^{-1}U \times \{1\} \rightarrow \pi^{-1}U$$

has image in the fiber F_a . Hence, g_1 may be factored as $g_1 = i \circ \phi$:

$$\pi^{-1}U \times \{1\} \xrightarrow{\phi} F_a \xrightarrow{i} \pi^{-1}U$$

So via g the composition $i \circ \phi$ is homotopic to the identity. To show that $\phi \circ i: F_a \rightarrow F_a$ is homotopic to the identity, consider the following diagram

$$\begin{array}{ccccc}
 F_a & \xrightarrow{i} & \pi^{-1}U & \xrightarrow{\text{identity}} & \pi^{-1}U \\
 \downarrow & & & \nearrow g & \downarrow \pi \\
 F_a \times I & \xrightarrow{j} & \pi^{-1}U \times I & \xrightarrow{\pi} & U \times I \xrightarrow{\gamma} U
 \end{array}$$

Note that $\phi \circ i = g \circ j|_{F_a \times \{1\}}$ is induced from the constant path $I \rightarrow \{a\} \in X$, since $\gamma \circ \pi \circ j(y, t) = a$ for all t . (The deformation retraction γ fixes a at all times.) By the proof of (a), $\phi \circ i$ is homotopic to the identity. \square

REMARK 16.4. If we replace F_a with any space Y , the argument in (a) proves that in the covering homotopy property (16.2), homotopic maps in X induce homotopic covering maps in E .

Generalizing the fact that a simply connected space cannot have a connected covering space of more than one sheets, we have the following.

Proposition 16.5. *Let $\pi: E \rightarrow X$ be a fibering. If X is simply connected and E is path connected, then the fibers are path connected.*

PROOF. Trivially the $E_2^{0,0}$ term of the fibering survives to E_∞ . Hence

$$E_2^{0,0} = E_\infty^{0,0} = H^0(E) = Z,$$

since E is path connected. On the other hand,

$$E_2^{0,0} = H^0(X, H^0(F)) = H^0(F).$$

Therefore $H^0(F) = Z$. \square

The Cohomology of the Loop Space of a Sphere

As an application of the spectral sequence of the path fibration, we compute here the integer cohomology groups of the loop space ΩS^n , $n \geq 2$.

EXAMPLE 16.6 (The 2-sphere). Since S^2 is simply connected, the spectral sequence of the path fibration

$$\begin{array}{c} \Omega S^2 \rightarrow PS^2 \\ \downarrow \\ S^2 \end{array}$$

has E_2 term

$$E_2^{p,q} = H^p(S^2, H^q(\Omega S^2)).$$

So the zeroth column $E_2^{0,q} = H^0(S^2, H^q(\Omega S^2)) = H^q(\Omega S^2)$ is the cohomology of the fiber. By Proposition 16.5, $H^0(\Omega S^2) = \mathbb{Z}$, so the bottom row $H_2^{p,0} = H^p(S^2, H^0(\Omega S^2)) = H^p(S^2, \mathbb{Z})$ is the cohomology of the base.

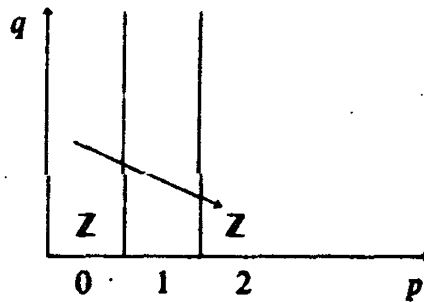

By the universal coefficient theorem (15.14), all columns in E_2 except $p = 0$ and $p = 2$ are zero. Hence all the differentials d_3, d_4, \dots are zero and $E_3^{p,q} = E_2^{p,q}$. Because the path space PS^2 is contractible,

$$E_\infty^{p,q} = \begin{cases} \mathbb{Z} & (p, q) = (0, 0) \\ 0 & \text{otherwise.} \end{cases}$$

Thus $d_2 : E_2^{0,1} \rightarrow E_2^{2,0}$ must be an isomorphism. It follows that $H^1(\Omega S^2) = \mathbb{Z}$. But then

$$E_2^{2,1} = H^2(S^2, H^1(\Omega S^2)) = H^2(S^2, \mathbb{Z}) = \mathbb{Z}.$$

Since $d_2 : E_2^{0,2} \rightarrow E_2^{2,1}$ is an isomorphism, $H^2(\Omega S^2) = \mathbb{Z}$. Working our way up, we find $H^q(\Omega S^2) = \mathbb{Z}$ in every dimension q .

EXAMPLE 16.7 (The 3-sphere). In the E_2 term of the fibering

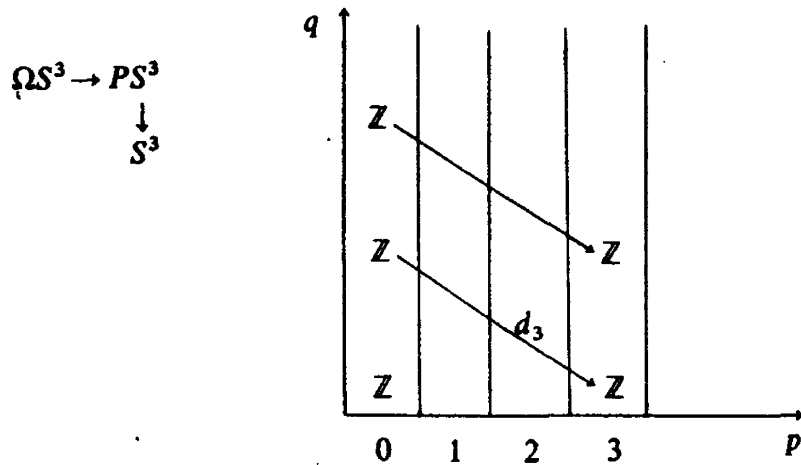

the nonzero columns are $p = 0$ and $p = 3$. For dimension reasons $d_2 = 0$ and $d_4 = d_5 = \dots = 0$. Because the total space is contractible, d_3 is an isomorphism except at $E_3^{0,0}$. Therefore,

$$H^*(\Omega S^3) = \begin{cases} \mathbb{Z} & \text{in even dimensions} \\ 0 & \text{otherwise.} \end{cases}$$

Similarly we find that in general

$$H^*(\Omega S^n) = \begin{cases} \mathbb{Z} & \text{in dimensions } 0, n-1, 2(n-1), \dots \\ 0 & \text{otherwise.} \end{cases}$$

Next we examine the ring structure of $H^*(\Omega S^n)$. We start with ΩS^2 . Let u be a generator of $E_2^{2,0} = H^2(S^2)$ and let x be the generator of $H^1(\Omega S^1)$ which is mapped to u by d_2 . For simplicity we occasionally write d for d_2 . By Example 16.6, the differential d_2 is an isomorphism. Note that x commutes with u because E_2 is the tensor product $H^*(\Omega S^2) \otimes H^*(S^2)$. (x is actually $x \otimes 1$ and u is $1 \otimes u$.)

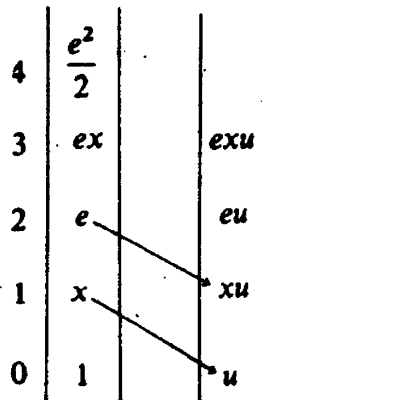

Since $d_2(x^2) = (d_2 x) \cdot x - x \cdot d_2 x = ux - xu = 0$, we have $x^2 = 0$. Thus the generator e in $H^2(\Omega S^2)$ which maps to xu is algebraically independent of x . Since $d(ex) = eu$, the product ex is a generator in dimension 3. Similarly, $d(e^2) = 2exu$ so that $e^2/2$ is a generator in dimension 4; $d((e^2/2)x) = (e^2/2)u$ so that $(e^2/2) \cdot x$ is a generator in dimension 5. By induction we shall prove

$$\frac{e^k}{k!} \text{ is a generator in dimension } 2k$$

and

$$\frac{e^k}{k!} x \text{ is a generator in dimension } 2k + 1.$$

PROOF. Suppose the claim is true for $k - 1$. Since

$$d \frac{e^k}{k!} = \frac{e^{k-1}}{(k-1)!} de = \frac{e^{k-1}}{(k-1)!} xu,$$

which is a generator of $E_2^{2, 2k-1}$, the element $e^k/k!$ is a generator of $H^{2k}(\Omega S^2)$. Similarly, since

$$d\left(\frac{e^k}{k!} x\right) = \frac{e^{k-1}}{(k-1)!} xu \cdot x + \frac{e^k}{k!} u = \frac{e^k}{k!} u,$$

which is a generator of $E_2^{2, 2k}$, the element $(e^k/k!)x$ is a generator of $H^{2k+1}(\Omega S^2)$. \square

By definition the exterior algebra $E(x)$ is the ring $Z[x]/(x^2)$ and the divided polynomial algebra $Z_*(e)$ with generator e is the Z -algebra with additive basis $\{1, e, e^2/2!, e^3/3!, \dots\}$. Hence

$$H^*(\Omega S^2) = E(x) \otimes Z_*(e),$$

where $\dim x = 1$ and $\dim e = 2$.

Now consider $H^*(\Omega S^n)$ for n odd. Let u be a generator of $H^n(S^n)$ and e the generator of $H^{n-1}(\Omega S^n)$ which maps to u under the isomorphism d_n . Since $d_n(e^2) = 2eu$, $e^2/2$ is a generator in dimension $2(n-1)$. In general if $e^k/k!$ is a generator in dimension $k(n-1)$, then $d_n(e^{k+1}/(k+1)!) = (e^k/k!)u$ so that $e^{k+1}/(k+1)!$ is a generator in dimension $(k+1)(n-1)$.

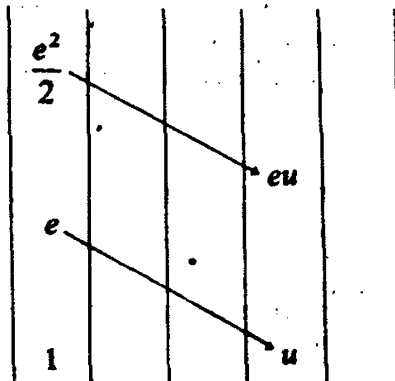

This shows that for n odd,

$$H^*(\Omega S^n) = Z_2(e), \quad \dim e = n - 1.$$

By a computation similar to that of $H^*(\Omega S^2)$, we see that for n even,

$$H^*(\Omega S^n) = E(x) \otimes Z_2(e), \quad \dim x = n - 1, \quad \dim e = 2(n - 1).$$

§17 Review of Homotopy Theory

To pave the way for later applications of the spectral sequence, we give in this section a brief account of homotopy theory. Following the definitions and basic properties of the homotopy groups, we compute some low-dimensional homotopy groups of the spheres. The geometrical ideas in this computation lead to the homotopy properties of attaching cells. A space built up from a collection of points by attaching cells is called a *CW* complex. To show that every manifold has the homotopy type of a *CW* complex, we make a digression into Morse theory. Returning to the main topic, we next discuss the relation between homotopy and homology, and indicate a proof of the Hurewicz isomorphism theorem using the homology spectral sequence. The homotopy groups of the sphere, $\pi_q(S^n)$, $q \leq n$, are immediate corollaries. Finally, venturing into the next nontrivial homotopy group, $\pi_3(S^2)$, we discuss the Hopf invariant in terms of differential forms. Some of the general references for homotopy theory are Hu[1], Steenrod [1], and Whitehead [1].

Homotopy Groups

Let X be a topological space with a base point $*$. For $q \geq 1$ the q th homotopy group $\pi_q(X)$ of X is defined to be the homotopy classes of maps from the q -cube I^q to X which send the faces I^q to $*$ to the base point of X . Equivalently $\pi_q(X)$ may be regarded as the homotopy classes of base-point preserving maps from the q -sphere S^q to X . The group operation on $\pi_q(X)$ is defined as follows (see Figure 17.1). If α and β are maps from I^q to X , representing $[\alpha]$ and $[\beta]$ in $\pi_q(X)$, then the product $[\alpha][\beta]$ is the homotopy class of the map

$$\gamma(t_1, \dots, t_q) = \begin{cases} \alpha(2t_1, t_2, \dots, t_q) & \text{for } 0 \leq t_1 \leq \frac{1}{2} \\ \beta(2t_1 - 1, t_2, \dots, t_q) & \text{for } \frac{1}{2} \leq t_1 \leq 1. \end{cases}$$

We recall here some basic properties of the homotopy groups.

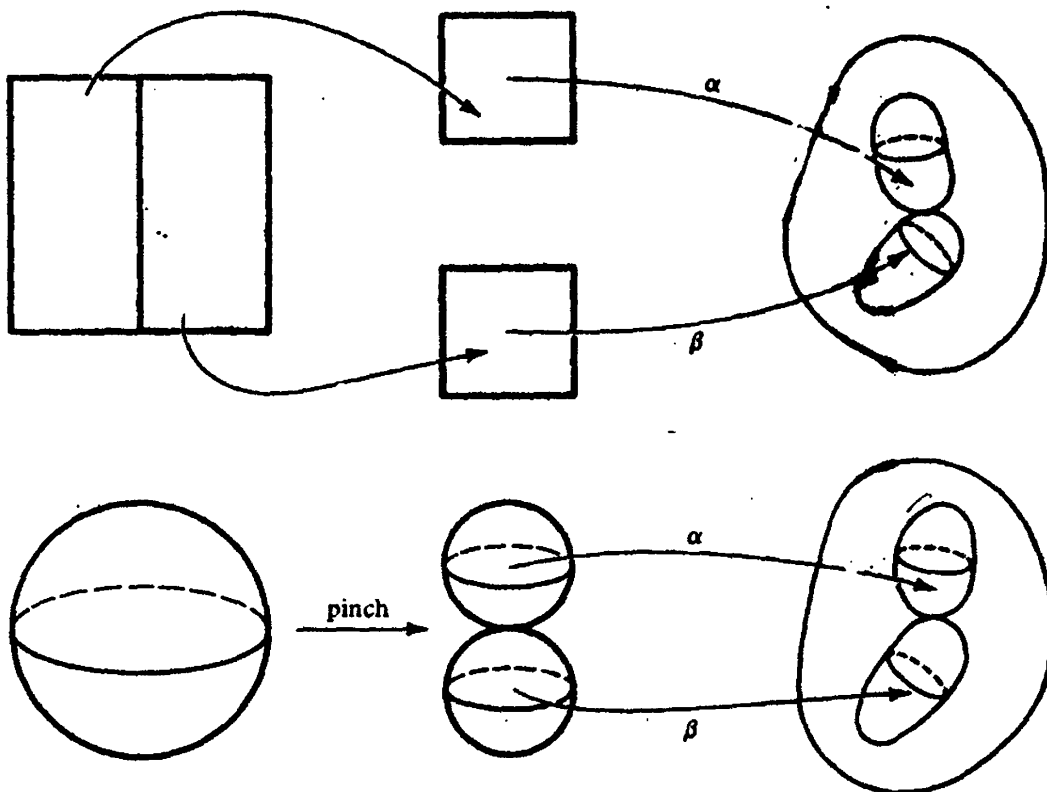

Figure 17.1

Proposition 17.1. (a) $\pi_q(X \times Y) = \pi_q(X) \times \pi_q(Y)$.
 (b) $\pi_q(X)$ is Abelian for $q > 1$.

PROOF. (a) is clear since every map from I^q into $X \times Y$ is of the form (f_1, f_2) where f_1 is a map into X and f_2 is a map into Y . Furthermore, since $(f_1, f_2)(g_1, g_2) = (f_1g_1, f_2g_2)$, the bijection in (a) is actually a group isomorphism. To prove (b), let $[\alpha]$ and $[\beta]$ be two elements of $\pi_q(X)$. We represent $\alpha\beta$ by

α	β
----------	---------

$$\gamma(t_1, \dots, t_q) = \begin{cases} \alpha(2t_1, t_2, \dots, t_q) & \text{for } 0 \leq t_1 \leq \frac{1}{2} \\ \beta(2t_1 - 1, t_2, \dots, t_q) & \text{for } \frac{1}{2} \leq t_1 \leq 1. \end{cases}$$

$\alpha\beta$ is homotopic to the map δ from I^q to X given by

α	*
*	β

$$\delta(t_1, \dots, t_q) = \begin{cases} \alpha(2t_1, 2t_2 - 1, t_3, \dots, t_q), & 0 \leq t_1 \leq \frac{1}{2}, \frac{1}{2} \leq t_2 \leq 1, \\ \beta(2t_1 - 1, 2t_2, \dots, t_q), & \frac{1}{2} \leq t_1 \leq 1, 0 \leq t_2 \leq \frac{1}{2}, \\ * & \text{otherwise.} \end{cases}$$

δ is in turn homotopic to

$$\begin{array}{|c|} \hline \alpha \\ \hline \beta \\ \hline \end{array},$$

$$\begin{array}{|c|c|} \hline * & \alpha \\ \hline \beta & * \\ \hline \end{array},$$

and finally to

$$\begin{array}{|c|c|} \hline & \alpha \\ \hline \beta & \\ \hline \end{array}$$

□

Proposition 17.2. $\pi_{q-1}(\Omega X) = \pi_q(X)$, $q \geq 2$.

SKETCH OF PROOF. Elements of $\pi_2(X)$ are given by maps of the square I^2 into X which send the boundary I^2 to the base point $*$. Such a map may be viewed as a *pencil of loops* in X , i.e., a map from the unit interval into ΩX . Therefore, $\pi_2(X) = \pi_1(\Omega X)$. The general case is similar; we view a map from I^n to X as a map from I^{n-1} to ΩX . □

It is often useful to introduce $\pi_0(X)$, which is defined to be the set of all path components of X . It has a distinguished element, namely the path component containing the base point of X . This component is the base point of $\pi_0(X)$. For a manifold the path components are the same as the connected components (Dugundji [1, Theorem IV.5.5, p. 116]).

Recall that a Lie group is a manifold endowed with a group structure such that the group operations—multiplication and the inverse operation—are smooth functions. Although $\pi_0(X)$ is in general *not* a group, if G is a Lie group, then $\pi_0(G)$ is a group. This follows from the following proposition.

Proposition 17.3. *The identity component H of a Lie group G is a normal subgroup of G . Therefore, $\pi_0(G) = G/H$ is a group.*

PROOF. Let a, b be in H . Since the continuous image of a connected set is connected, bH is a connected set having a nonempty intersection with H .

Hence $bH \subset H$. It follows that $abH \subset aH \subset H$, so ab is in H . Similarly $a^{-1}H$ is a connected set having a nonempty intersection with H , since 1 is in $a^{-1}H$; so $a^{-1}H \subset H$ and a^{-1} is also in H . This shows that H is a subgroup of G .

Let g be an element of G . Since gHg^{-1} is a connected set containing 1 , by the same reasoning as above, $gHg^{-1} \subset H$. Thus H is normal.

Because multiplication by g is a homeomorphism, the coset gH is connected. Since distinct cosets are disjoint, G/H consists of precisely the connected components of G . Therefore, $\pi_0(G) = G/H$. \square

Let $\pi : E \rightarrow B$ be a (base-point preserving) fibering with fiber F . Then there is an exact sequence of homotopy groups, called the *homotopy sequence* of the fibering (Steenrod [1, p. 91]):

$$(17.4) \quad \cdots \rightarrow \pi_q(F) \xrightarrow{i_*} \pi_q(E) \xrightarrow{\pi_*} \pi_q(B) \xrightarrow{\partial} \pi_{q-1}(F) \rightarrow \cdots$$

$$\cdots \rightarrow \pi_0(E) \rightarrow \pi_0(B) \rightarrow 0.$$

In this exact sequence the last three maps are not group homomorphisms, but only set maps. The kernel of a set map between pointed sets is by definition the inverse image of the base point. Exactness in this context is given by the same condition as before: "the image equals the kernel." The maps i_* and π_* are the maps induced by the inclusion $i : F \rightarrow E$ and the projection $\pi : E \rightarrow B$ respectively. Here we regard F as the fiber over the base point of B . To describe ∂ we use the covering homotopy property of a fibering. For simplicity consider first $q = 1$. A loop $\alpha : I^1 \rightarrow B$ from the unit interval to B , representing an element of $\pi_1(B)$, may be lifted to a path $\bar{\alpha}$ in E with $\bar{\alpha}(0)$ being the base point of F . Then $\partial[\alpha]$ is given by $\bar{\alpha}(1)$ in $\pi_0(F)$. More generally let $I^{q-1} \subset I^q$ be the inclusion

$$(t_1, \dots, t_{q-1}) \mapsto (t_1, \dots, t_{q-1}, 0).$$

A map $\alpha : I^q \rightarrow B$ representing an element of $\pi_q(B)$ may be regarded as a homotopy of $\alpha|_{I^{q-1}}$ in B . Let the constant map $*$: $I^{q-1} \rightarrow E$ from I^{q-1} to the base point of F be the map that covers $\alpha|_{I^{q-1}} : (t_1, \dots, t_{q-1}, 0) \rightarrow B$. By the covering homotopy property, there is a homotopy upstairs $\bar{\alpha} : I^q \rightarrow E$ which covers α and such that $\bar{\alpha}|_{I^{q-1}} = *$. Then $\partial[\alpha]$ is the homotopy class of the map $\bar{\alpha} : (t_1, \dots, t_{q-1}, 1) \rightarrow F$. By Remark 16.4, $\partial[\alpha]$ is well-defined.

EXAMPLE 17.5. A covering space $\pi : E \rightarrow B$ is a fibering with discrete fibers. By the homotopy sequence of the fibering,

$$\pi_q(E) = \pi_q(B) \quad \text{for } q \geq 2$$

and

$$\pi_1(E) \hookrightarrow \pi_1(B).$$

WARNING 17.6 (Dependence on base points). Consider the homotopy groups $\pi_q(X, x)$ and $\pi_q(X, y)$ of a path-connected space X , computed relative to two different points x and y . A path γ from x to y induces by conjugation a map from the loop space $\Omega_x X$ to the loop space $\Omega_y X$:

$$\lambda \mapsto \gamma\lambda\gamma^{-1} \quad \text{for any } \lambda \text{ in } \Omega_x X.$$

This in turn induces a map of homotopy groups

$$\gamma_*: \pi_{q-1}(\Omega_x X, \bar{x}) \rightarrow \pi_{q-1}(\Omega_y X, \bar{y}),$$

$$\begin{array}{ccc} \parallel & & \parallel \\ \pi_q(X, x) & & \pi_q(X, y) \end{array}$$

where \bar{x} and \bar{y} are the constant maps to x and y . The map γ_* is clearly an isomorphism, with inverse given by $(\gamma^{-1})_*$.

We can describe γ_* explicitly as follows. Let $[\alpha]$ be an element of $\pi_q(X, x)$. Define a map F to be α on the bottom face of the cube I^{q+1} and γ on the vertical faces (Figure 17.2 (a)); more precisely, if $(u, t) \in I^q \times I = I^{q+1}$, then

$$F(u, 0) = \alpha(u) \text{ for all } u \text{ in } I^q$$

and

$$F(u, t) = \gamma(t) \text{ for all } u \text{ in } \partial I^q.$$

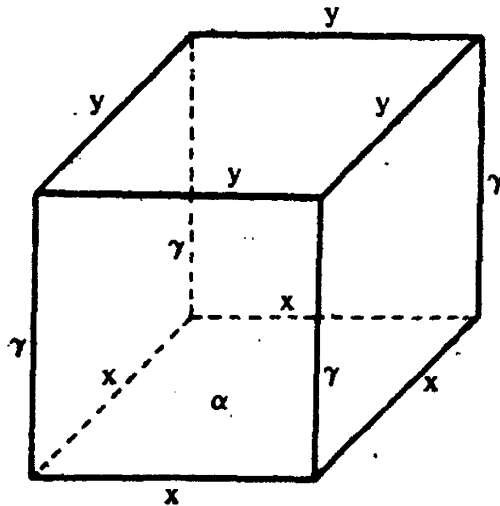

Figure 17.2(a)

By the box principle from obstruction theory (which states that a map from the union of all but one face of a cube into any space can be extended to the whole cube), the map F can be extended to the entire I^{q+1} . Its restriction to the top face represents $\gamma_*[\alpha]$.

One checks easily that γ_* is independent of the homotopy class of γ amongst the paths from x to y , so that when we take $x = y$, the assignment $\gamma \mapsto \gamma_*$ may be thought of as an action of $\pi_1(X, x)$ on $\pi_q(X, x)$. Only if this

action is trivial, can one speak unambiguously of $\pi_q(X)$ without reference to a base point. In that case one can also identify the *free* homotopy classes of maps $[S^q, X]$ with $\pi_q(X)$; here by a free homotopy we mean a homotopy that does not necessarily preserve the base points. In general, however, $[S^q, X]$ is not a group and its relation to $\pi_q(X)$ is given by the following.

Proposition 17.6.1. *Let X be a path-connected space. The inclusion of base-point preserving maps into the set of all maps induces a bijection*

$$\pi_q(X, x)/\pi_1(X, x) \xrightarrow{\sim} [S^q, X],$$

where the notation on the left indicates the equivalence relation $[\alpha] \sim \gamma_*[\alpha]$ for $[\gamma]$ in $\pi_1(X, x)$.

PROOF. Let $h: \pi_q(X, x) \rightarrow [S^q, X]$ be induced by the inclusion of base point preserving maps into the set of all maps. If $[\alpha] \in \pi_q(X, x)$ and $[\gamma] \in \pi_1(X, x)$, it is laborious but not difficult to write down an explicit free homotopy between α and $\gamma_*\alpha$ (see Figure 17.2 (b) for the cases $q = 1$ and $q = 2$). Hence h factors through the action of $\pi_1(X, x)$ on $\pi_q(X, x)$ and

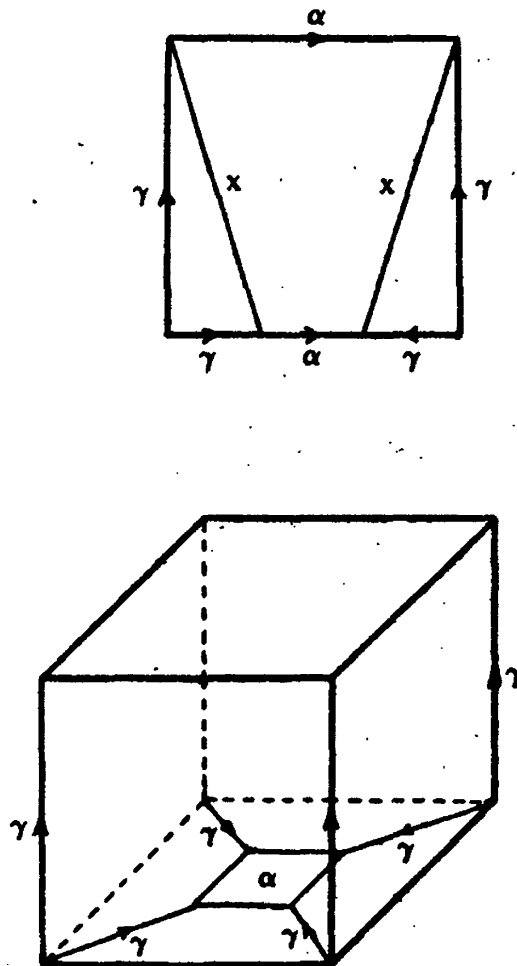

Figure 17.2(b)

defines a map

$$H: \pi_q(X, x)/\pi_1(X, x) \rightarrow [S^q, X].$$

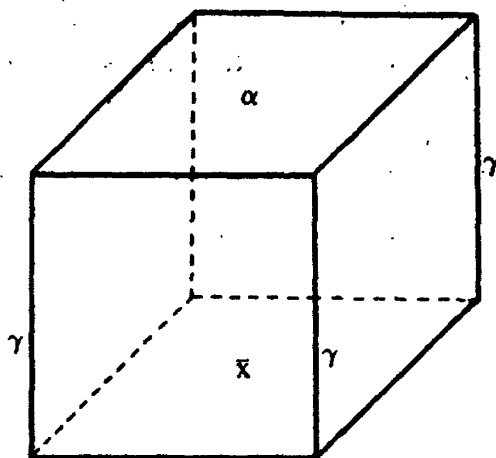

Figure 17.2(c)

Since X is path connected, any map in $[S^q, X]$ can be deformed to a base-point preserving map. So H is surjective. To show injectivity, suppose $[\alpha]$ in $\pi_q(X, x)$ is null-homotopic in $[S^q, X]$. This means there is a map $F: I^{q+1} \rightarrow X$ such that

$$F|_{\text{top face}} = \alpha,$$

$$F|_{\text{bottom face}} = \bar{x},$$

and F is constant on the boundary of each horizontal slice (Figure 17.2 (c)). Let γ be the restriction of F to a vertical segment. Then $\alpha = \gamma_*(\bar{x})$. Therefore, H is injective. \square

The Relative Homotopy Sequence

Let X be a space with base point $*$, and A a subset of X (See Figure 17.3). Denote by Ω_*^A the space of all paths from $*$ to A . The endpoint map $e: \Omega_*^A \rightarrow A$ gives a fibering

$$\begin{array}{ccc} \Omega X & \rightarrow & \Omega_*^A \\ & & \downarrow \\ & & A. \end{array}$$

The homotopy sequence of this fibering is

$$\begin{array}{ccccccc} \cdots & \rightarrow & \pi_q(A) & \rightarrow & \pi_{q-1}(\Omega X) & \rightarrow & \pi_{q-1}(\Omega_*^A) \rightarrow \pi_{q-1}(A) \rightarrow \cdots \\ & & & & & & \cdots \rightarrow \pi_0(\Omega_*^A) \rightarrow \pi_0(A) \rightarrow 0. \end{array}$$

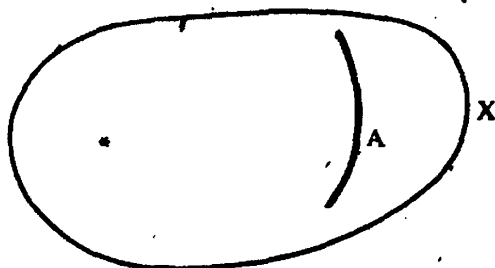

Figure 17.3

We define the *relative homotopy group* $\pi_q(X, A)$ to be $\pi_{q-1}(\Omega_X^A)$. Then the sequence above becomes the *relative homotopy sequence of A in X*:

$$(17.7) \quad \cdots \rightarrow \pi_q(A) \rightarrow \pi_q(X) \rightarrow \pi_q(X, A) \rightarrow \pi_{q-1}(A) \rightarrow \cdots$$

$$\cdots \rightarrow \pi_1(X, A) \rightarrow \pi_0(A) \rightarrow 0.$$

Observe that $\pi_q(X, A)$ is an Abelian group for $q \geq 3$, $\pi_2(X, A)$ is a group but in general not Abelian, while $\pi_1(X, A)$ is only a set.

Some Homotopy Groups of the Spheres

In this section we will compute $\pi_q(S^n)$ for $q \leq n$. Although these homotopy groups are immediate from the Hurewicz isomorphism theorem (17.21), the geometric proof presented here is important in being the pattern for later discussions of the homotopy properties of attaching cells (17.11).

Proposition 17.8 *Every continuous map $f : M \rightarrow N$ between two manifolds is continuously homotopic to a differentiable map.*

PROOF. We first note that if $f : M \rightarrow \mathbb{R}$ is a continuous function and ε a positive number, then there is a differentiable real-valued function h on M with $|f - h| < \varepsilon$. This is more or less clear from the fact that via its graph, f may be regarded as a continuous section of the trivial bundle $M \times \mathbb{R}$ over M ; in any ε -neighborhood of f there is a differentiable section h and because the ε -neighborhood of f may be continuously deformed onto f , h is continuously homotopic to f (see Figure 17.4). Indeed, to be more explicit, this differentiable section h can be given by successively averaging the values of f over small disks.

Next consider a continuous map $f : M \rightarrow N$ of manifolds. By the Whitney embedding theorem (see, for instance, de Rham [1, p. 12]), there is a differentiable embedding $g : N \rightarrow \mathbb{R}^n$. If

$$g \circ f : M \rightarrow g(N) \subset \mathbb{R}^n$$

is homotopic to a differentiable map, then so is

$$f = g^{-1} \circ (g \circ f) : M \rightarrow N.$$

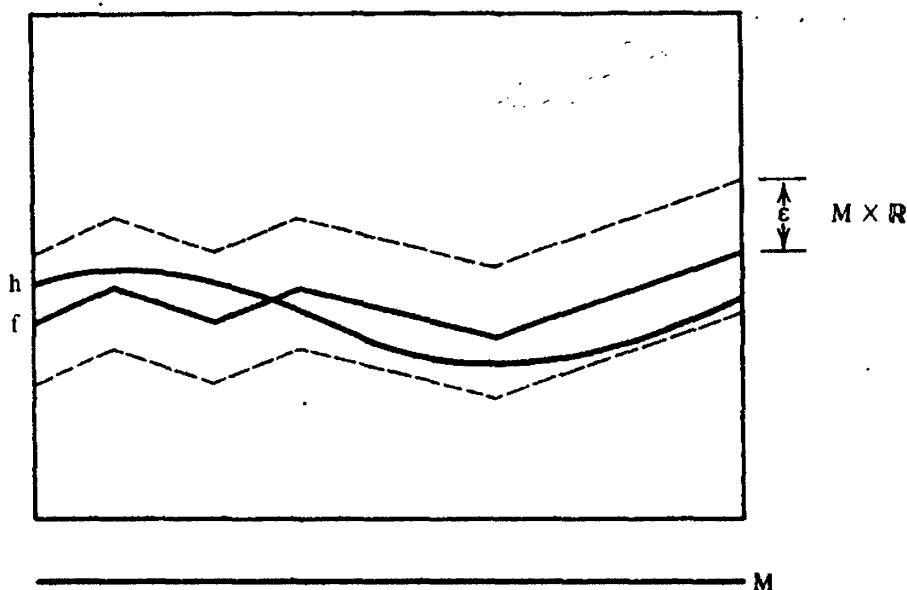

Figure 17.4

So we may assume at the outset that N is a submanifold of an Euclidean space \mathbb{R}^n . Then the map f is given by continuous real-valued functions (f_1, \dots, f_n) . As noted above, each coordinate function f_i can be approximated by a differentiable function h_i to within ϵ , and f_i is continuously homotopic to h_i . Thus we get a differentiable map $h: M \rightarrow \mathbb{R}^n$ whose image is in some tubular neighborhood T of N . But every tubular neighborhood of N can be deformed to N via a differentiable map $k: T \rightarrow N$ (Figure 17.5). This gives a differentiable map $k \circ h: M \rightarrow N$ which is homotopic to f . \square

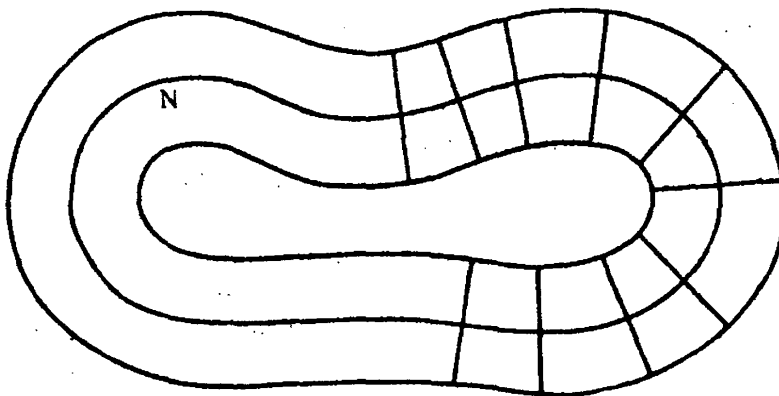

Figure 17.5

Corollary 17.8.1. *Let M be a manifold. Then the homotopy groups of M in the C^∞ sense are the same as the homotopy groups of M in the continuous sense.*

Proposition 17.9. $\pi_q(S^n) = 0$, for $q < n$.

PROOF. Let f be a continuous map from I^q to S^n , representing an element of $\pi_q(S^n)$. By the lemma above, we may assume f differentiable. Hence Sard's

theorem applies. Because q is strictly less than n , the image of f are all critical values. By Sard's theorem f cannot be surjective. Choose a point P not in the image of f and let c be a contraction of $S^n - \{P\}$ to the antipodal point Q of P (Figure 17.6):

$$c_t : S^n - \{P\} \rightarrow S^n - \{P\}, t \in [0, 1]$$

$$c_0 = \text{identity}$$

$$c_1 = \text{constant map } Q.$$

Then $c_t \circ f$ is a homotopy between f and the constant map Q . Therefore, $\pi_q(S^n) = 0$ for $q < n$. \square

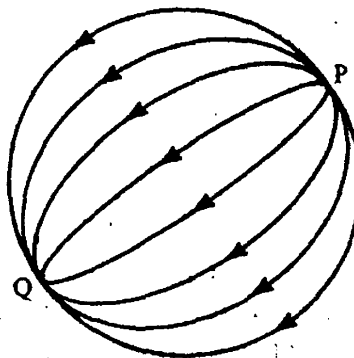

Figure 17.6

Proposition 17.10. $\pi_n(S^n) = \mathbb{Z}$.

We will indicate here the main ideas in the geometrical proof of this statement, omitting some technical details.

Recall that to every map from S^n to S^n one can associate an integer called its degree. Since the degree is a homotopy invariant, it gives a map $\text{deg} : \pi_n(S^n) \rightarrow \mathbb{Z}$. There are two key lemmas.

Lemma 17.10.1. *The map $\text{deg} : \pi_n(S^n) \rightarrow \mathbb{Z}$ is a group homomorphism; that is,*

$$\text{deg}[f\theta] = \text{deg}[f] + \text{deg}[\theta].$$

Lemma 17.10.2 *Two maps from S^n to S^n of the same degree can be deformed into each other.*

The surjectivity of deg follows immediately from Lemma 17.10.1, since if f is the identity map, then $\text{deg}(f^k) = k$ for any integer k ; the injectivity follows from (17.10.2).

To prove these lemmas we will deform any map $f : S^n \rightarrow S^n$ into a normal form as follows. By the inverse function theorem f is a local diffeomorphism around a regular point. By Sard's theorem regular values exist. Let U be an open set around a regular value so that $f^{-1}(U)$ consists of finitely many disjoint open sets, U_1, \dots, U_r , each of which f maps diffeo-

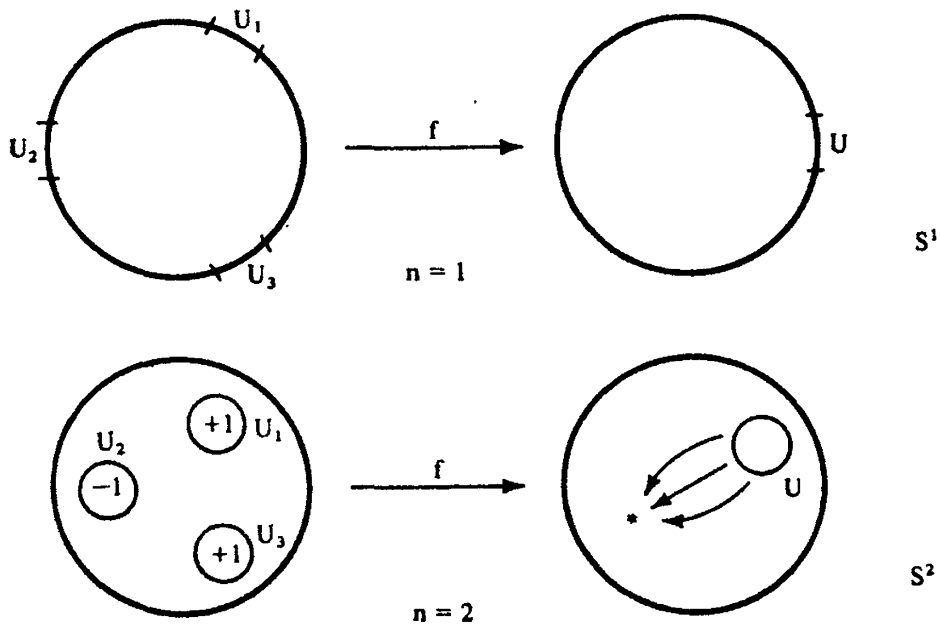

Figure 17.7

morphically onto U (Figure 17.7). Choose the base point $*$ of S^n to be not in U . We deform the map f by deforming U in such a way that the complement of U goes into $*$. The deformed f then maps the complement of $\bigcup_{i=1}^k U_i$ to $*$. Each U_i comes with a multiplicity of ± 1 depending on whether f is orientation preserving or reversing on U_i . The degree of f is the sum of these multiplicities. Given two maps f and g from S^n to S^n , we deform each as above, choosing U to be a neighborhood of a regular value of both f and g . By summing the multiplicities of the inverse images of U , we see that $\deg(fg) = \deg f + \deg g$ (Figure 17.8). This proves Lemma 17.10.1.

To bring a map $f : S^n \rightarrow S^n$ into what we consider its normal form requires one more step. If U_i and U_j have multiplicities $+1$ and -1 respectively, we join U_i to U_j with a path. It is plausible that f can be deformed further so that it maps $U_i \cup U_j$ to the base point $*$, since f wraps U_i around the sphere one way and U_j the reverse way. For S^1 this is clear.

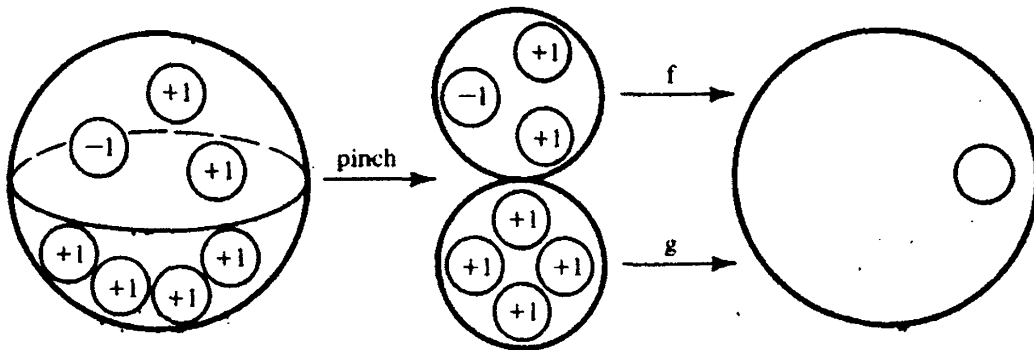

Figure 17.8

The general case is where we wave our hands. The details are quite involved and can be found in Whitney [1]. In this way pairs of open sets with opposite multiplicities are cancelled out. In the normal form, if f has degree $\pm k$, then there are exactly k open sets, U_1, \dots, U_k , with all $+1$ multiplicities or all -1 multiplicities. Hence two maps from S^n to S^n of the same degree can be deformed into each other.

Attaching Cells

Let e^n be the closed n -disk and S^{n-1} its boundary. Given a space X and a map $f: S^{n-1} \rightarrow X$, the space Y obtained from X by attaching the n -cell e^n via f is by definition (see Figure 17.9)

$$Y = X \cup_f e^n = X \amalg e^n / f(u) \sim u, \text{ for } u \in S^{n-1}.$$

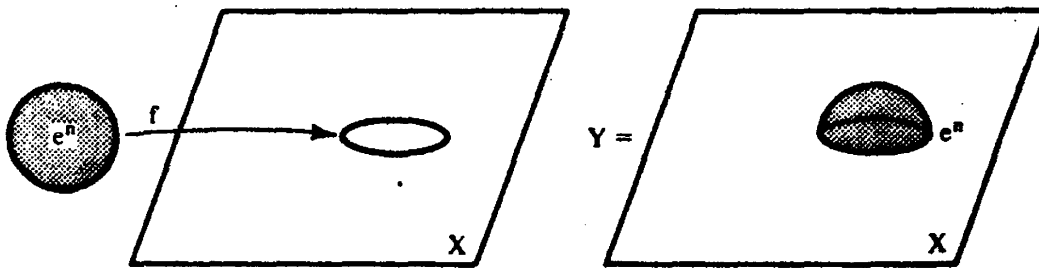

Figure 17.9

For example, the 2-sphere is obtained from a point by attaching a 2-cell (Figure 17.10):

$$S^2 = p \cup e^2.$$

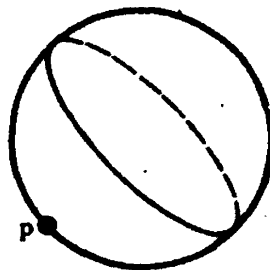

Figure 17.10

It is easy to show that if f and g are homotopic maps from S^{n-1} to X , then $X \cup_f e^n$ and $X \cup_g e^n$ have the same homotopy type (see Bott and Mather [1, Prop. 1, p. 466] for an explicit homotopy). The most fundamental homotopy property of attaching an n -cell is the following.

Proposition 17.11. *Attaching an n -cell to a space X does not alter the homotopy in dimensions strictly less than $n - 1$, but may kill elements in $\pi_{n-1}(X)$;*

more precisely, the inclusion $X \hookrightarrow X \cup e^n$ induces isomorphisms

$$\pi_q(X) \cong \pi_q(X \cup e^n) \quad \text{for } q < n - 1$$

and a surjection

$$\pi_{n-1}(X) \rightarrow \pi_{n-1}(X \cup e^n).$$

PROOF. Assume $q \leq n - 1$ and let $f: S^q \rightarrow X \cup e^n$ be a continuous base-point preserving map. We would like first of all to show that f is homotopic to some map whose image does not contain all of e^n . If f is differentiable and $X \cup_f e^n$ is a manifold, this follows immediately from Sard's theorem. In fact, as long as f is differentiable on some submanifold of S^q that maps into e^n , the same conclusion holds. As in the proof of Proposition 17.8 this can always be arranged by moving the given f in its homotopy class. So we may assume that f does not surject onto e^n . Choose a point p not in the image and fix a retraction c_1 of $(e^n - \{p\})$ to the boundary of e^n . This gives a retraction c_1 of $X \cup (e^n - \{p\})$ to X . Via $c_1 \circ f$, the map f is homotopic in $X \cup e^n$ to a map from S^q to X (Figure 17.11). Hence $\pi_q(X) \rightarrow \pi_q(X \cup e^n)$ is surjective for $q \leq n - 1$.

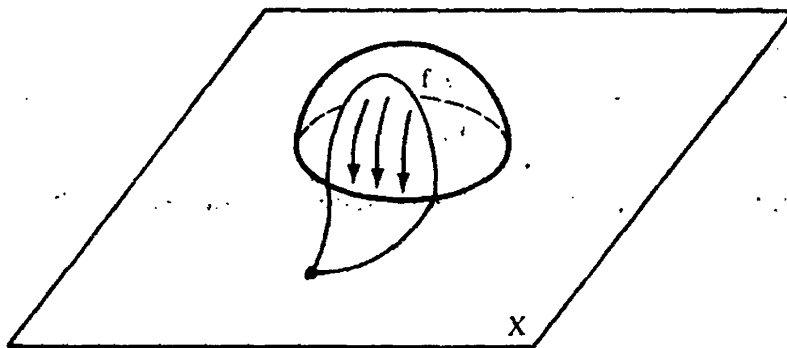
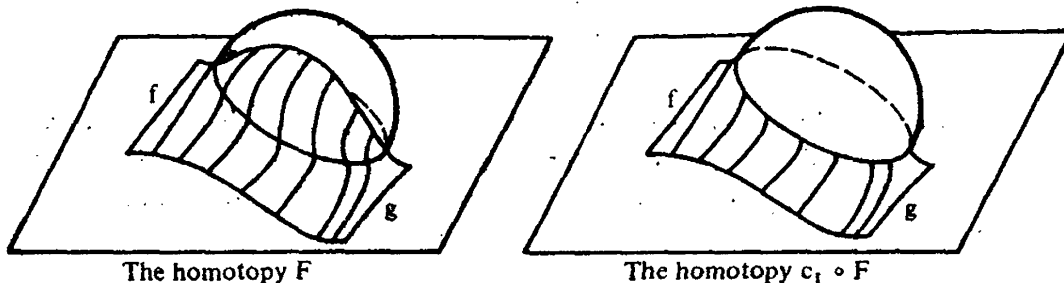

Figure 17.11

Now assume $q \leq n - 2$. To show injectivity let f and g be two maps representing elements of $\pi_q(X)$ which have the same image in $\pi_q(X \cup e^n)$. Let $F: S^q \times I \rightarrow X \cup e^n$ be a homotopy in $X \cup e^n$ between f and g . Since the dimension of $S^q \times I$ is less than n , again we can deform F so that its



The homotopy F

The homotopy $c_1 \circ F$

Figure 17.12

image does not contain all of e^n . Reasoning as before, we find maps

$$c_t \circ F : S^q \times I \rightarrow X \cup e^n$$

such that $c_1 \circ F : S^q \times \{1\} \rightarrow X$ is a homotopy between f and g which lies in X (Figure 17.12). Therefore $[f] = [g]$ as elements of $\pi_q(X)$. \square

As for homology we have the following:

Proposition 17.12. *Attaching an n -cell to a space X via a map f does not alter the homology except possibly in dimensions $n - 1$ and n . Writing X_f for $X \cup_f e^n$, there is an exact sequence*

$$0 \rightarrow H_n(X) \rightarrow H_n(X_f) \rightarrow \mathbb{Z} \xrightarrow{f_*} H_{n-1}(X) \rightarrow H_{n-1}(X_f) \rightarrow 0$$

where $f_* : H_{n-1}(S^{n-1}) \rightarrow H_{n-1}(X)$ is the induced map. So the inclusion $X \hookrightarrow X_f$ induces a surjection in dimension $n - 1$ and an injection in dimension n .

PROOF. Let U be $X_f - \{p\}$ where p is the origin of e^n , and let V be $\{x \in e^n \mid \|x\| < \frac{1}{2}\}$. Then U is homotopic to X , V is contractible, and $\{U, V\}$ is an open cover of X_f . By the Mayer-Vietoris sequence (15.6), the following is exact

$$\dots \rightarrow H_q(S^{n-1}) \rightarrow H_q(X) \oplus H_q(V) \rightarrow H_q(X_f) \rightarrow H_{q-1}(S^{n-1}) \rightarrow \dots$$

So for $q \neq n - 1$ or n , $H_q(X_f) = H_q(X)$. For $q = n$, we have

$$0 \rightarrow H_n(X) \rightarrow H_n(X_f) \rightarrow H_{n-1}(S^{n-1}) \xrightarrow{f_*} H_{n-1}(X) \rightarrow H_{n-1}(X_f) \rightarrow 0. \quad \square$$

A *CW complex* is a space Y built up from a collection of points by the successive attaching of cells; the topology of Y is required to be the so-called *weak topology*: a set in Y is closed if and only if its intersection with every cell is closed. (By a cell we mean a *closed cell*.) The cells of dimension at most n in a CW complex Y together comprise the *n -skeleton* of Y . Clearly every triangularizable space is a CW complex. Every manifold is also a CW complex; this is most readily seen in the framework of Morse theory, as we will show in the next subsection.

For us the importance of the CW complexes comes from the following proposition.

Proposition 17.13. *Every CW complex is homotopy equivalent to a space with a good cover.*

Hence the entire machinery of the spectral sequence that we have developed applies to CW complexes. This proposition follows from the nontrivial fact that every CW complex has the homotopy type of a simplicial complex (Gray

[1, Cor. 16.44, p. 149, and Cor. 21.15, p. 206] or Lundell and Weingram [1, Cor. 4.7, p. 131]), for the open star of the simplicial complex is a good cover.

Digression on Morse Theory

Using Morse theory, it can be shown that every differentiable manifold has the homotopy type of a CW complex (see Milnor [2, p. 36]). The goal of this section is to prove this for the simpler case of a *compact* differentiable manifold.

Let f be a smooth real-valued function on a manifold M . A *critical point* of f is a point p where $df = 0$; in terms of local coordinates x_1, \dots, x_n centered at p , the condition $df(p) = \sum (\partial f / \partial x_i)(p) dx_i = 0$ is equivalent to the vanishing of all the partial derivatives $(\partial f / \partial x_i)(p)$. The image $f(p)$ of a critical point is called a *critical value*. Note that the definition of a critical point given here is a special case of the more general definition preceding Theorem 4.11 for a map between manifolds. A critical point is *nondegenerate* if for some coordinate system x_1, \dots, x_n centered at p , the matrix of second partials, $((\partial^2 f / \partial x_i \partial x_j)(p))$, is nonsingular; this matrix is called the *Hessian* of f relative to the coordinate system x_1, \dots, x_n at p . The notion of a nondegenerate critical point is independent of the choice of coordinate systems, for if y_1, \dots, y_n is another coordinate system centered at p , then

$$\frac{\partial f}{\partial y_\epsilon} = \sum_j \frac{\partial f}{\partial x_j} \frac{\partial x_j}{\partial y_\epsilon}$$

and

$$\frac{\partial^2 f}{\partial y_k \partial y_\epsilon} = \sum_{i,j} \frac{\partial^2 f}{\partial x_i \partial x_j} \frac{\partial x_i}{\partial y_k} \frac{\partial x_j}{\partial y_\epsilon} + \sum_j \frac{\partial f}{\partial x_j} \frac{\partial^2 x_j}{\partial y_k \partial y_\epsilon}.$$

At p , $\partial f / \partial x_j = 0$, so that

$$\frac{\partial^2 f}{\partial y_k \partial y_\epsilon} = \sum_{i,j} \frac{\partial^2 f}{\partial x_i \partial x_j} \frac{\partial x_i}{\partial y_k} \frac{\partial x_j}{\partial y_\epsilon}.$$

In matrix notation

$$H(y) = J'H(x)J$$

where $H(x)$ is the Hessian of f relative to the coordinate system x_1, \dots, x_n , and J is the Jacobian $(\partial x_i / \partial y_k)$. Since the Jacobian is nonsingular, $\det(\partial^2 f / \partial y_k \partial y_\epsilon) \neq 0$ if and only if $\det(\partial^2 f / \partial x_i \partial x_j) \neq 0$. The *index* of a nondegenerate critical point is the number of negative eigenvalues in the Hessian of f . By Sylvester's theorem from linear algebra, the index is independent of the coordinate systems. It may be interpreted as the number of independent directions along which f is decreasing.

EXAMPLE 17.14. Consider a torus in 3-space sitting on a plane as shown in Figure 17.13. Let $f(p)$ be the height of the point p above the plane. Then as a function on the torus f has four critical points $A, B, C,$ and $D,$ of indices 0, 1, 1, and 2 respectively.

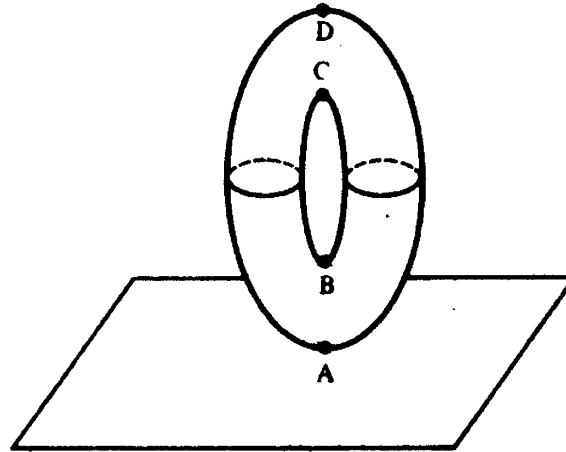

Figure 17.13

We outline below the proofs of the two main theorems of Morse theory. For details the reader is referred to Milnor [2, §3] or Bott and Mather [1, pp. 468–472].

Theorem 17.15. Let f be a differentiable function on the manifold $M,$ and M_a the set $f^{-1}([-\infty, a]).$ If $f^{-1}([a, b])$ is compact and contains no critical points, then M_a has the same homotopy type as $M_b.$

OUTLINE OF PROOF. Choose a Riemannian structure $\langle \cdot, \cdot \rangle$ on $M.$ Then away from the critical points of $h,$ the gradient ∇h of a differentiable function f is defined: it is the unique vector field on M such that for all vector fields Y on $M,$

$$\langle \nabla h_p, Y_p \rangle = dh_p(Y_p).$$

Let X be the unit vector field $-\nabla f / \|\nabla f\|.$ Because f has no critical points on

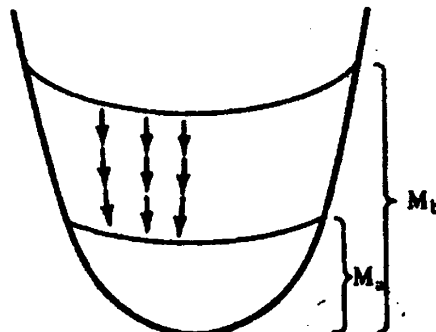

Figure 17.14

$f^{-1}([a, b])$, X is defined on $f^{-1}([a, b])$. As in vector calculus on \mathbb{R}^n the gradient of a function points in the direction of the fastest increase, so X points in the direction of the fastest decrease. Extend X to a vector field on M . The flow lines of X give a deformation retraction of M_b onto M_a (Figure 17.14).

□

Theorem 17.16. *Suppose $f^{-1}([a, b])$ is compact and contains precisely one critical point in its interior, which is nondegenerate and of index k . Then M_b has the homotopy type of $M_a \cup e^k$.*

To prove this theorem we need the following.

Morse lemma. *If p is a nondegenerate critical point of f of index k , then there is a coordinate system x_1, \dots, x_n near p such that*

$$f = f(p) - x_1^2 - \dots - x_k^2 + x_{k+1}^2 + \dots + x_n^2.$$

The Morse lemma may be proved by the method used to diagonalize quadratic forms (see Milnor [2, p. 6]).

OUTLINE OF A PROOF OF THEOREM 17.16. Let $c = f(p)$ be the critical value and ε a small positive number. By Theorem 17.15, M_b has the homotopy type of $M_{c+\varepsilon}$, and M_a that of $M_{c-\varepsilon}$, so it suffices to show that $M_{c+\varepsilon}$ has the homotopy type of $M_c \cup e^k$.

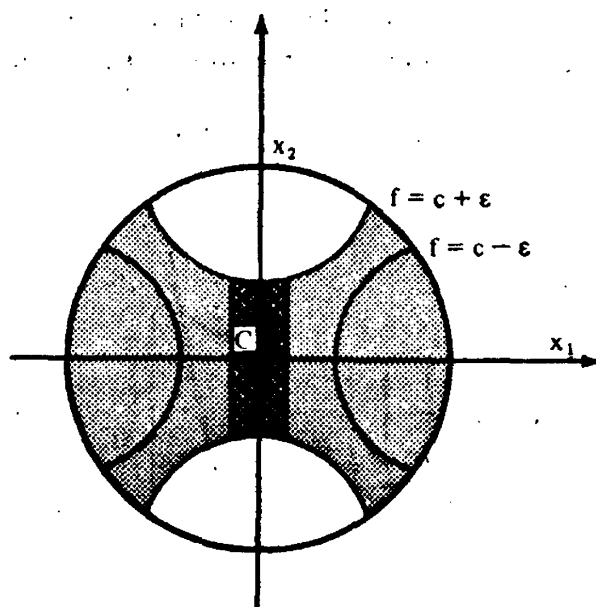

Figure 17.15

On a neighborhood U of p where the Morse lemma holds,

$$M_{c+\epsilon} \cap U = \{-x_1^2 - \cdots - x_k^2 + x_{k+1}^2 + \cdots + x_n^2 \leq \epsilon\}$$

$$M_{c-\epsilon} \cap U = \{-x_1^2 - \cdots - x_k^2 + x_{k+1}^2 + \cdots + x_n^2 \leq -\epsilon\}$$

These regions are illustrated in Figure 17.15 for $k = 1$ and $n = 2$. The set $M_{c+\epsilon}$ is the shaded portion. (We choose ϵ small enough so that U meets the level sets $f^{-1}(c + \epsilon)$ and $f^{-1}(c - \epsilon)$.)

Let C be the subset of U defined by

$$C = \{f \leq c + \epsilon, x_1^2 + \cdots + x_k^2 \leq \delta\},$$

where δ is a small positive number, say smaller than ϵ^2 . Note that C is homotopically equivalent to the cell e^k . Set $B = M_{c+\epsilon} - C$. B is the shaded region in the picture in Figure 17.16. From the picture it is plausible that B can be contracted onto $M_{c-\epsilon}$ by moving along the vector field $-\nabla f$. Since $M_{c+\epsilon}$ is obtained from B by attaching C , up to homotopy

$$M_{c+\epsilon} \simeq M_{c-\epsilon} \cup e^k.$$

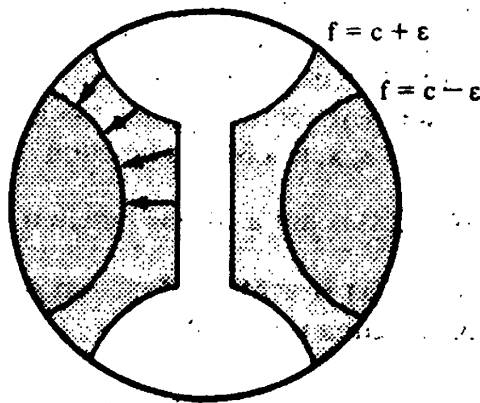

Figure 17.16

A smooth real-valued function on a manifold all of whose critical points are nondegenerate is called a *Morse function*. It follows from the two preceding theorems that there is a very close relation between the topology of a manifold and the critical points of a Morse function. We next show that there are many Morse functions on any manifold. Our proof is taken from Guillemin and Pollack [1, pp. 43–45].

Lemma 17.17. *Let U be an open subset of \mathbb{R}^n and f any smooth real-valued function on U . Then for almost all $a = (a_1, \dots, a_n)$ in \mathbb{R}^n , the function $f_a(x) = f(x) + a_1x_1 + \cdots + a_nx_n$ is a Morse function.*

PROOF. Recall that we denote the Jacobian matrix of a function h by $D(h)$. Define $g(x) = (\partial f/\partial x_1, \dots, \partial f/\partial x_n)$. Note that the Hessian of f is precisely the

Jacobian of g , and x is a nondegenerate critical point of f if and only if $g(x) = 0$ and $D(g)(x)$ is nonsingular. Let $g_a(x) = (\partial f_a / \partial x_1, \dots, \partial f_a / \partial x_n)$. Then $g_a(x) = g(x) + a$ and $D(g_a) = D(g)$. In this setup x is a critical point of f_a if and only if $g(x) = -a$; it is nondegenerate if and only if in addition $D(g)(x)$ is nonsingular, i.e., a is a regular value of g . By Sard's theorem almost all a in \mathbb{R}^r are regular values of g . For any such a , the function f_a will be a Morse function on U . \square

Proposition 17.18. *Let M be a manifold of dimension n in \mathbb{R}^r . For almost all $a = (a_1, \dots, a_r)$ in \mathbb{R}^r , the function $f(x) = a_1 x_1 + \dots + a_r x_r$ is a Morse function on M .*

PROOF. Let x_1, \dots, x_r be the coordinate functions on \mathbb{R}^r . Every point x in M has a neighborhood U in M on which some n of x_1, \dots, x_r form a coordinate system. (Proof: Since $T_x M \rightarrow T_x \mathbb{R}^r$ is injective, $T_x^* \mathbb{R}^r \rightarrow T_x^* M$ is surjective, so dx_1, \dots, dx_r restrict to a spanning set in the cotangent space $T_x^* M$. If $dx_{i_1}, \dots, dx_{i_n}$ is a basis for $T_x^* M$, then x_{i_1}, \dots, x_{i_n} is a set of local coordinates around x .) Because a manifold is by definition second countable, M can be covered by a countable number of such open sets, $M = \bigcup_{i=1}^{\infty} U_i$. Suppose x_1, \dots, x_n form a local coordinate system on U_i . Fix (a_{n+1}, \dots, a_r) and define $f(x) = a_{n+1} x_{n+1} + \dots + a_r x_r$ on U_i . By Lemma 17.17, for almost all (a_1, \dots, a_n) , the function $f(x) + a_1 x_1 + \dots + a_n x_n$ is a Morse function on U_i . It follows that for almost all $a = (a_1, \dots, a_r)$ in \mathbb{R}^r , the function $f_a(x) = a_1 x_1 + \dots + a_r x_r$ is a Morse function on U_i . Let

$$A_i = \{a \in \mathbb{R}^r \mid f_a(x) \text{ is not a Morse function on } U_i\}.$$

If $a \in \mathbb{R}^r - \bigcup_{i=1}^{\infty} A_i$, then $f_a(x)$ is a Morse function on M . Since $\bigcup_{i=1}^{\infty} A_i$ has measure zero, the proposition is proved. \square

Theorem 17.19. *Every compact manifold M has the homotopy type of a finite CW complex.*

PROOF. By Whitney's embedding theorem (see de Rham [1, p. 12]), we may assume that M is a submanifold of some Euclidean space. Let f be a Morse function on M (the existence of f is guaranteed by Proposition 17.18). By the Morse lemma, the critical points of f are isolated. Since M is compact, f can have only finitely many critical points on M . Furthermore, for any real number a , the set $M_a = f^{-1}([-\infty, a])$ is compact, as it is a closed subset of a compact set. Let p_1, \dots, p_r be the critical points of index 0. By the two main theorems of Morse theory (Theorems 17.15 and 17.16), up to homotopy M is constructed from p_1, \dots, p_r by attaching cells, a cell of dimension k for each critical point of index $k > 0$. Hence M has the homotopy type of a finite CW complex.

The Relation between Homotopy and Homology

The relation between the homotopy and the homology functors is a very subtle one. There is of course a natural homomorphism

$$i: \pi_q(X) \rightarrow H_q(X),$$

defined as follows: fix a generator u for $H_q(S^q)$ and send $[f]$ in $\pi_q(X)$ to $f_*(u)$. In general i is neither injective nor surjective. We have seen that H_q is relatively computable. On the other hand, π_q is not; there is no analogue of the Mayer-Vietoris principle for π_q . For this reason, the following theorems are a cornerstone of homotopy theory.

Theorem 17.20. *Let X be a path-connected space. Then $H_1(X)$ is the Abelianization of $\pi_1(X)$, i.e., if $[\pi_1(X), \pi_1(X)]$ is the commutator subgroup of $\pi_1(X)$, then $H_1(X) = \pi_1(X)/[\pi_1(X), \pi_1(X)]$.*

We will assume this theorem as known. Its proof may be found in, for instance, Greenberg [1, p. 48]. The higher-dimensional analogue is

Theorem 17.21 (Hurewicz Isomorphism Theorem). *Let X be a simply connected path-connected CW complex. Then the first nontrivial homotopy and homology occur in the same dimension and are equal, i.e., given a positive integer $n \geq 2$, if $\pi_q(X) = 0$ for $1 \leq q < n$, then $H_q(X) = 0$ for $1 \leq q < n$ and $H_n(X) = \pi_n(X)$.*

PROOF. To start the induction, consider the case $n = 2$. The E^2 term of the homology spectral sequence of the path fibration

$$\begin{array}{ccc} \Omega X & \rightarrow & PX \\ & & \downarrow \\ & & X \end{array}$$

is

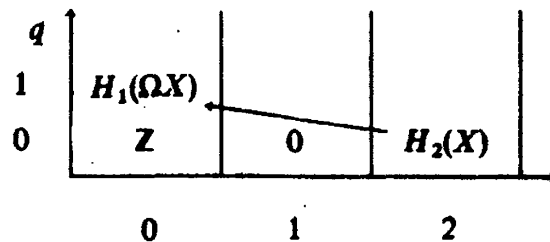

Thus

$$\begin{aligned} H_2(X) &= H_1(\Omega X) && \text{because } PX \text{ has no homology} \\ &= \pi_1(\Omega X) && \text{because } \pi_1(\Omega X) = \pi_2(X) \text{ is Abelian} \\ &= \pi_2(X). \end{aligned}$$

Now let n be any positive integer greater than 2. By the induction hypothesis applied to ΩX ,

$$H_q(\Omega X) = 0 \quad \text{for } q < n - 1$$

and

$$H_{n-1}(\Omega X) = \pi_{n-1}(\Omega X) = \pi_n(X).$$

The E_2 term of the homology spectral sequence of the path fibration is

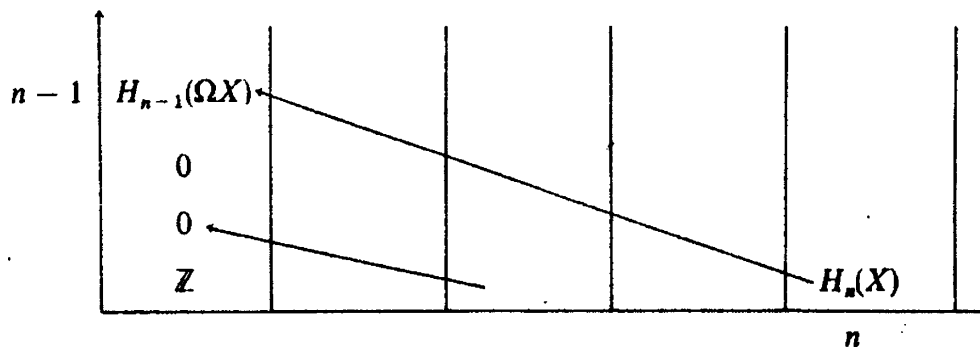

Since PX has trivial homology,

$$H_q(X) = H_{q-1}(\Omega X) = 0 \quad \text{for } 1 \leq q < n$$

and

$$H_n(X) = H_{n-1}(\Omega X) = \pi_n(X).$$

□

REMARK 17.21.1. A careful reader should have noticed that there is a sleight of hand in this deceptively simple proof: because we developed the Leray spectral sequence for spaces with a good cover (Theorem 15.11 and its homology analogue), to be strictly correct, we must show that both X and ΩX have good covers. By (17.13), the CW complex X has a good cover. Next we quote the theorem of Milnor that the loop space of a CW complex is again a CW complex (Milnor [1, Cor. 3, p. 276]). So, at least up to homotopy, ΩX also has a good cover.

Actually the Hurewicz theorem is true for any path-connected topological space. This is a consequence of the CW -approximation theorem which, in the form that we need, states that *given any topological space X there is a CW complex K , unique up to homotopy, such that X and K have the same homotopy and homology groups* (Whitehead [1, Ch. V, Section 3, p. 219]). In its more general form, the CW -approximation theorem implies that in homotopy theory every space may be assumed to be a CW complex. In any case, in the Hurewicz isomorphism theorem, we may drop the requirement that X be a CW complex.

The spectral sequence proof of the Hurewicz isomorphism theorem is due to Serre [2, pp. 271–274]. Actually, Serre’s approach is slightly different; by developing a spectral sequence which is valid in much greater generality than ours, Serre could bypass the question of the existence of a good cover on a topological space. Of course, a price has to be paid for this greater generality; one has to work much harder to establish Serre’s spectral sequence.

As a first and very important example, consider S^n again. It follows from the Hurewicz theorem and the homology of S^n that the homotopy groups of S^n in low dimensions are

$$\pi_q(S^n) = 0 \quad \text{for } q < n$$

and

$$\pi_n(S^n) = \mathbb{Z}.$$

$\pi_3(S^2)$ and the Hopf Invariant

Now that we have computed $\pi_q(S^n)$ for $q \leq n$, the first nontrivial computation of the homotopy of a sphere is $\pi_3(S^2)$. This can be done using the homotopy exact sequence of the *Hopf fibration*, as follows.

Let S^3 be the unit sphere $\{(z_0, z_1) \mid |z_0|^2 + |z_1|^2 = 1\}$ in \mathbb{C}^2 . Define an equivalence relation on S^3 by

$$(z_0, z_1) \sim (w_0, w_1) \quad \text{if and only if} \quad (z_0, z_1) = (\lambda w_0, \lambda w_1)$$

for some complex number λ of absolute value 1. The quotient S^3/\sim is the complex projective space CP^1 and the fibering

$$\begin{array}{c} S^1 \rightarrow S^3 \\ \downarrow \\ S^2 = CP^1 \end{array}$$

is the *Hopf fibration*. From the exact homotopy sequence

$$\cdots \rightarrow \pi_q(S^1) \rightarrow \pi_q(S^3) \rightarrow \pi_q(S^2) \rightarrow \pi_{q-1}(S^1) \rightarrow \cdots$$

and the fact that $\pi_q(S^1) = 0$ for $q \geq 2$, we get $\pi_q(S^3) = \pi_q(S^2)$ for $q \geq 3$. In particular $\pi_3(S^2) = \mathbb{Z}$.

This homotopy group $\pi_3(S^2)$ was first computed by H. Hopf in 1931 using a linking number argument which associates to each homotopy class of maps from S^3 to S^2 an integer now called the *Hopf invariant*. We give here an account of the Hopf invariant first in the dual language of differential forms and then in terms of the linking number. Thus the setting for this section is the differentiable category.

Let $f: S^3 \rightarrow S^2$ be a differentiable map and let α be a generator of $H_{DR}^2(S^2)$. Since $H_{DR}^2(S^3) = 0$, there exists a 1-form ω on S^3 such that

$f^*\alpha = d\omega$. As will be shown below, the expression

$$H(f) = \int_{S^2} \omega \wedge d\omega$$

is independent of the choice of ω . We define $H(f)$ to be the *Hopf invariant* of f .

More generally the same procedure defines the Hopf invariant for any differentiable map $f: S^{2n-1} \rightarrow S^n$. If α is a generator of $H_{DR}^n(S^n)$, then $f^*\alpha = d\omega$ for some $(n-1)$ -form ω on S^{2n-1} and the Hopf invariant of f is

$$H(f) = \int_{S^{2n-1}} \omega \wedge d\omega.$$

Proposition 17.22. (a) *The definition of the Hopf invariant is independent of the choice of ω .*

(b) *For odd n the Hopf invariant is 0.*

(c) *Homotopic maps have the same Hopf invariant.*

PROOF. (a) Let ω' be another $(n-1)$ -form on S^{2n-1} such that $f^*\alpha = d\omega'$. Then $0 = d(\omega - \omega')$. Hence

$$\begin{aligned} \int_{S^{2n-1}} \omega \wedge d\omega - \int_{S^{2n-1}} \omega' \wedge d\omega' &= \int_{S^{2n-1}} (\omega - \omega') \wedge d\omega \\ &= \int_{S^{2n-1}} d((\omega - \omega') \wedge \omega) \\ &= 0 \quad \text{by Stokes' theorem.} \end{aligned}$$

(b) Since ω is even-dimensional,

$$\omega \wedge d\omega = \frac{1}{2}d(\omega \wedge \omega).$$

By Stokes' theorem, $\int_{S^{2n-1}} \omega \wedge d\omega = 0$.

(c) By (b) we may assume n even. Let $F: S^{2n-1} \times I \rightarrow S^n$ be a homotopy between the two maps f_0 and f_1 from S^{2n-1} to S^n , where $I = [0, 1]$. If i_0 is the inclusion

$$i_0: S^{2n-1} \rightarrow S_0 = S^{2n-1} \times \{0\} \subset S^{2n-1} \times I$$

and similarly for i_1 , then

$$F \circ i_0 = f_0,$$

$$F \circ i_1 = f_1.$$

Let α be a generator of $H_{DR}^n(S^n)$. Then $F^*\alpha = d\omega$ for some $(n-1)$ -form ω on $S^{2n-1} \times I$. Define $i_0^*\omega = \omega_0$ and $i_1^*\omega = \omega_1$. Then

$$f_0^*\alpha = d\omega_0 \quad \text{and} \quad f_1^*\alpha = d\omega_1.$$

Note that

$$\omega_0 \wedge d\omega_0 = i_0^*(\omega \wedge d\omega).$$

Hence,

$$\begin{aligned}
 H(f_1) - H(f_0) &= \int_{S^{2n-1}} \omega_1 \wedge d\omega_1 - \int_{S^{2n-1}} \omega_0 \wedge d\omega_0 \\
 &= \int_{S^{2n-1}} i_1^*(\omega \wedge d\omega) - \int_{S^{2n-1}} i_0^*(\omega \wedge d\omega) \\
 &= \int_{S_1} \omega \wedge d\omega - \int_{S_0} \omega \wedge d\omega \\
 &= \int_{\partial(S^{2n-1} \times I)} \omega \wedge d\omega \\
 &= \int_{S^{2n-1} \times I} d\omega \wedge d\omega \quad \text{by Stokes' theorem} \\
 &= \int_{S^{2n-1} \times I} F^*(\alpha \wedge \alpha) \\
 &= 0 \quad \text{because } \alpha \wedge \alpha \in \Omega^{2n}(S^n).
 \end{aligned}$$

□

Since homotopy groups can be computed using only smooth maps (Proposition 17.8.1), it follows from Proposition 17.22(c) that the Hopf invariant gives a map

$$H: \pi_{2n-1}(S^n) \rightarrow \mathbb{R}.$$

We leave it as an exercise to the reader to prove that H is in fact a homomorphism.

Actually the Hopf invariant is always an integer and is geometrically given by the *linking number* of the pre-images $A = f^{-1}(p)$ and $B = f^{-1}(q)$ of any two distinct regular values of f . In the classical case where $n = 2$, these two submanifolds are two "circles" embedded in S^3 . To fix the ideas we will first explain the linking concept for this case.

The linking number of two disjoint oriented circles A and B in S^3 can be defined in several quite different but equivalent ways.

The Intersection-Theory Definition.

Choose a smooth surface D in S^3 with boundary A such that D intersects B transversally (Figure 17.17). Set the linking number to be

$$\text{link}(A, B) = \sum_{D \cap B} \pm 1.$$

Here the sum is extended over the points in the intersection of D with B and the sign is given by the usual convention: at a point x in $D \cap B$, the sign is

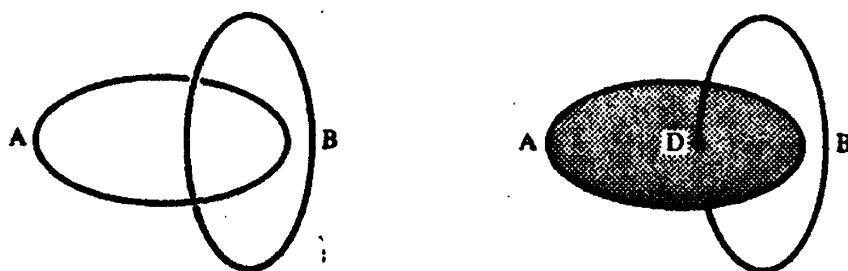

Figure 17.17

+1 or -1 according to whether the tangent space $T_x S^3$ has or does not have the direct sum orientation of $T_x D \oplus T_x B$ (Guillemin and Pollack [1, p. 108]).

It of course has to be shown that the linking number as defined is independent of the choice of D . This is a consequence of the discussion to follow.

The Differential-Form Definition.

Choose disjoint open neighborhoods W_A and W_B of A and B and choose representatives η_A and η_B of the compact Poincaré duals of A and B in $H_c^2(W_A)$ and $H_c^2(W_B)$. Because $H_{DR}^2(S^3) = 0$, the extensions of η_A and η_B by zero to all of S^3 , also denoted η_A and η_B , are exact. Thus there are 1-forms ω_A and ω_B on S^3 such that

$$d\omega_A = \eta_A \quad \text{and} \quad d\omega_B = \eta_B.$$

In terms of these forms one would expect, naively, that the dual to the intersection-theory definition is the expression

$$\int_{S^3} \omega_A \wedge \eta_B,$$

for if $A = \partial D$ and $\eta_A = d\omega_A$, then in some sense D should correspond to ω_A . So let this integral be the differential-form definition of the linking number of A and B . We have to check that it is independent of all the choices involved. Let ω'_A be some other form with $d\omega'_A = \eta_A$. Then $\omega'_A - \omega_A$ is closed. So

$$\begin{aligned} \int_{S^3} (\omega'_A - \omega_A) \wedge \eta_B &= \pm \int_{S^3} d[(\omega'_A - \omega_A) \wedge \omega_B] \\ &= 0. \end{aligned}$$

On the other hand, if η'_B is another representative of $[\eta_B]$, then

$$\eta_B - \eta'_B = d\mu$$

for some μ in $\Omega_c^1(W_B)$. Hence,

$$\int_{S^3} \omega_A \wedge (\eta_B - \eta'_B) = - \int_{S^3} d(\omega_A \wedge \mu) + \int_{S^3} \eta_A \wedge \mu.$$

Both terms on the right vanish: the first by Stokes' theorem, and the second because the supports of η_A and μ are disjoint!

The differential-form definition is quite close to the Hopf invariant. To bring one into the other, we first choose disjoint neighborhoods U_p and U_q of the regular values p and q of f and set $W_A = f^{-1}(U_p)$ and $W_B = f^{-1}(U_q)$. We next choose forms α_p and α_q in $\Omega_c^2(U_p)$ and $\Omega_c^2(U_q)$ representing the Poincaré duals of p and q and set $\eta_A = f^*\alpha_p$ and $\eta_B = f^*\alpha_q$. According to the differential-form definition the linking number of $f^{-1}(p) = A$ and $f^{-1}(q) = B$ is then given by

$$\int_{S^3} \omega_A \wedge \eta_B,$$

where ω_A is a form on S^3 with $d\omega_A = \eta_A$. On the other hand, as α_p generates $H_{DR}^2(S^2)$, the Hopf invariant is given by

$$H(f) = \int_{S^3} \omega_A \wedge \eta_A.$$

Because α_p and α_q are both representatives for the generator of $H_{DR}^2(S^2)$, there is a form β in $\Omega^2(S^2)$ such that

$$\alpha_p - \alpha_q = d\beta.$$

Hence,

$$\begin{aligned} \omega_A \wedge (\eta_A - \eta_B) &= \omega_A \wedge f^* d\beta \\ &= -d(\omega_A \wedge f^*\beta) + (d\omega_A) \wedge f^*\beta. \end{aligned}$$

The last term on the right equals

$$\eta_A \wedge f^*\beta = f^*(\alpha_p \wedge \beta).$$

But $\alpha_p \wedge \beta \in \Omega^3(S^2)$ and hence vanishes! By Stokes' theorem it follows that

$$\int_{S^3} \omega_A \wedge \eta_B = \int_{S^3} \omega_A \wedge \eta_A = H(f),$$

as was to be shown.

Finally we prove the compatibility of the two definitions of the linking number. This will then also explain why the Hopf invariant is always an integer.

To start off one needs certain plausible constructions of differential topology. The first of these is that a surface such as D , which has boundary A , can always be extended by a small ribbon diffeomorphic to $A \times [0, 1]$. More precisely, there exists an embedding

$$\phi: A \times [-1, 1] \hookrightarrow S^3$$

such that ϕ maps $A \times [-1, 0]$ diffeomorphically onto a closed neighborhood of $A = \delta D$ in D , with $A \times \{0\}$ going to A , and such that

$$D_1 = D \cup \phi(A \times [0, 1])$$

is still a smoothly embedded manifold with boundary. If we set

$$D_{-1} = D - \phi(A \times (-1, 0]),$$

this construction exhibits D in a nested sequence of submanifolds with boundary

$$D_1 \supset D \supset D_{-1}$$

with the interior of $D_1 - D_{-1}$ being diffeomorphic to $A \times (-1, 1)$. A map ϕ of this type is often called a *collar* about ∂D , and the restriction of ϕ to $A \times (-1, 1)$ an *open collar* about ∂D .

Using this parametrization we can clearly construct a smooth function χ_A on D_1 such that

- (1) $\chi_A \equiv 0$ near ∂D_1 , and
- (2) $\chi_A \equiv 1$ on a neighborhood of D_{-1} in D_1 .

It follows that $d\chi_A$ is a 1-form with compact support on the open collar $D_1^\circ - D_{-1}$, where D_1° is the interior of D_1 . Furthermore, $d\chi_A$ represents the compact Poincaré dual of A in $\Omega_c^1(D_1^\circ - D_{-1})$.

Next we choose a neighborhood of D_1 in S^3 , say W , small enough to admit a retraction

$$r: W \rightarrow D_1.$$

(For ε small enough an ε -neighborhood of D_1 relative to some Riemannian structure on S^3 will do.) Let T be a tubular neighborhood of $D_1 - \partial D_1$ in $W - \partial D_1$ diffeomorphic to the unit disk bundle in the normal bundle of $D_1 - \partial D_1$ in $W - \partial D_1$ and let ω_A° represent the Thom class of T in $\Omega_{cv}^1(T)$. See Figure 17.18.

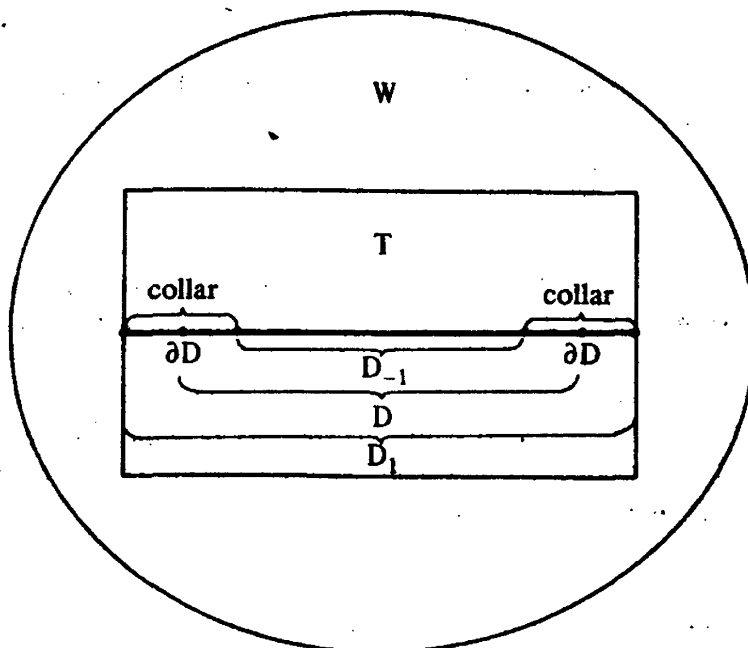

Figure 17.18

Now consider the 1-form

$$\omega_A = (r^*\chi_A)\omega_A^\circ.$$

It has many virtues. First of all it has compact support in W and so can be extended by zero to all of S^3 . This comes about because ω_A° has compact support normal to D_1° and $r^*\chi_A$ vanishes identically near ∂D_1 . Secondly, we see that if we set

$$W_A = r^{-1}(D_1^\circ - D_{-1}),$$

then $d\omega_A \in \Omega_c^2(W_A)$ and represents the compact Poincaré dual of A there.

We will use this ω_A in the integral $\int_{S^3} \omega_A \wedge \eta_B$ to complete the argument that

$$\int_{S^3} \omega_A \wedge \eta_B = \sum_{D \cap B} \pm 1.$$

First choose a small enough neighborhood W_B of B , a small enough collar for D , and a small enough tubular neighborhood T for D_1° so that (see Figure 17.19)

$$W_B \cap T \subset r^{-1}(D_{-1}).$$

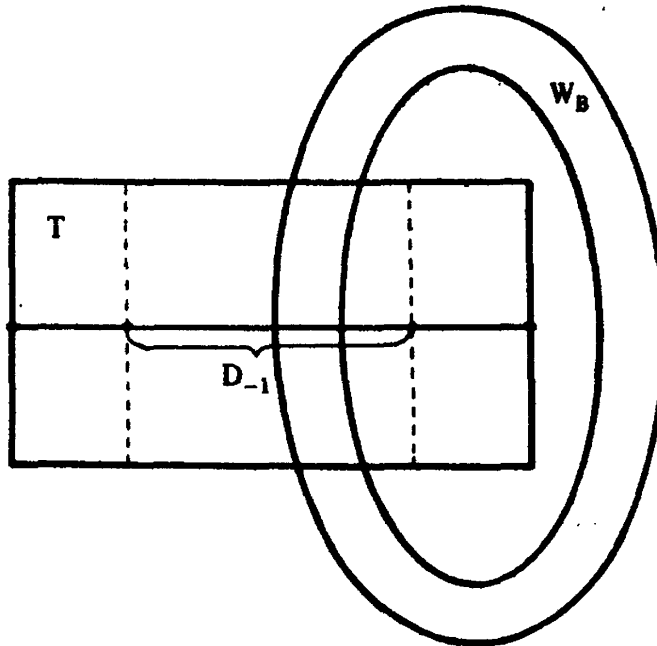

Figure 17.19

Once this is done ω_A will equal ω_A° in the support of η_B since on $r^{-1}(D_{-1})$ the function $r^*\chi_A$ is identically 1. Therefore, our integral can be rewritten in the form

$$(*) \quad \int_{S^3 - \partial D_1} \omega_A^\circ \wedge \eta_B.$$

But now ω_A° represents the Poincaré dual of D_1° in $\Omega^1(S^3 - \partial D_1)$ and η_B the compact Poincaré dual of B in $\Omega_c^1(S^3 - \partial D_1)$. In Section 6 we discussed the relation between the Thom isomorphism, Poincaré duality, and the transversal intersections of closed oriented submanifolds. Although (6.24) and (6.31) were stated for the closed Poincaré duals, the same discussion applies to the compact Poincaré duals, provided the relevant submanifolds are compact. Hence the integral (*) just counts the transversal intersection number of D_1 with B . Thus

$$\int_{S^3} \omega_A \wedge \eta_B = \sum_{D_1 \cap B} \pm 1 = \sum_{D \cap B} \pm 1,$$

the last being valid because the extension D_1 intersects B no more often than D did. \square

REMARK. The arguments of this section of course extend to the higher-dimensional examples. In particular the two definitions of the linking number make sense and are equivalent whenever A and B are compact oriented submanifolds of an oriented manifold M satisfying the following conditions:

- (1) A and B are disjoint;
- (2) $\dim A + \dim B = \dim M - 1$;
- (3) both A and B are bounding in the sense that their fundamental classes are homologous to zero in $H_*(M)$.

Linking is therefore not a purely homological concept.

We cannot resist mentioning at this point that there is yet a third definition of the linking number of two disjoint oriented circles A and B in S^3 .

The Degree Definition.

Remove a point p from S^3 not on A or B and identify $S^3 - \{p\}$ with \mathbb{R}^3 . Let

$$L: A \times B \rightarrow S^2$$

be the map to the unit sphere in \mathbb{R}^3 given by

$$L(x, y) = \frac{x - y}{\|x - y\|},$$

where $\| \cdot \|$ denotes the Euclidean length in \mathbb{R}^3 . Give $A \times B$ the product orientation and S^2 the standard orientation. Then

$$\text{link}(A, B) = \text{deg } L.$$

We close this section with two explicit computations of the Hopf invariant in the classical case, one using the differential-geometric and the other the intersection point of view. Just to be sure, if you will.

EXAMPLE 17.23 (The Hopf invariant of the Hopf fibration). Let S^3 be the unit sphere in \mathbb{C}^2 and $f: S^3 \rightarrow \mathbb{C}P^1$ the natural map

$$f: (z_0, z_1) \rightarrow [z_0, z_1],$$

where we write $[z_0, z_1]$ for the homogeneous coordinates on $\mathbb{C}P^1$. If $\mathbb{C}P^1$ is identified with the unit sphere S^2 in \mathbb{R}^3 , say via the stereographic projection, then the map $f: S^3 \rightarrow S^2$ is the Hopf fibration. To compute its Hopf invariant, we proceed in five steps:

- Find a volume form σ on the 2-sphere.
- Write down a diffeomorphism $g: \mathbb{C}P^1 \xrightarrow{\sim} S^2$.
- Pull the generator σ of $H^2(S^2)$ via g back to a generator α of $H^2(\mathbb{C}P^1)$.
- Pull α back to S^3 via f and find a 1-form ω such that $f^*\alpha = d\omega$ on S^3 .
- Compute $\int_{S^3} \omega \wedge d\omega$.

(a) *A Volume Form on the 2-Sphere.*

Let u_1, u_2 , and u_3 be the standard coordinates of \mathbb{R}^3 . By Exercise 4.3.1 a generator of $H^2(S^2)$ is

$$\sigma = \frac{1}{4\pi} (u_1 du_2 du_3 - u_2 du_1 du_3 + u_3 du_1 du_2).$$

Since $(dr) \cdot \sigma = (r/4\pi) du_1 du_2 du_3$, which is the standard orientation on \mathbb{R}^3 , the form σ represents the *positive* generator on S^2 (see the discussion preceding Exercise 6.32).

Over the open set in S^2 where $u_3 \neq 0$, the form σ has a simpler expression. For if

$$u_1^2 + u_2^2 + u_3^2 = 1,$$

then

$$u_1 du_1 + u_2 du_2 + u_3 du_3 = 0,$$

so that we can eliminate du_3 from σ to get

$$(17.23.1) \quad \sigma = \frac{1}{4\pi} \frac{du_1 du_2}{u_3}.$$

(b) *Stereographic Projection of S^2 onto $\mathbb{C}P^1$.*

In the homogeneous coordinates $[z_0, z_1]$ on $\mathbb{C}P^1$, the single point $[z_0, 0]$ is called the *point at infinity*. On the open set $z_1 \neq 0$, we may use $z = z_0/z_1$ as the coordinate and identify the point $z = x + iy$ in $\mathbb{C}P^1 - \{[1, 0]\}$ with the point $(x, y, 0)$ of the (u_1, u_2) -plane in \mathbb{R}^3 . Then the stereographic projection

from the north pole $(0, 0, 1)$ maps S^2 onto CP^1 , sending the north pole to the point at infinity (Figure 17.20). To find the inverse map $g: CP^1 \rightarrow S^2$, note that the line through $(0, 0, 1)$ and $(x, y, 0)$ has parametric equation $(0, 0, 1) + t(x, y, -1)$, which intersects the unit sphere when

$$t^2x^2 + t^2y^2 + (1-t)^2 = 1,$$

that is,

$$t = 0 \quad \text{or} \quad \frac{2}{1+x^2+y^2}.$$

Hence the inverse map $g: CP^1 \rightarrow S^2 \subset \mathbb{R}^3$ is given by

$$(17.23.2) \quad z = x + iy \mapsto \left(\frac{2x}{1+x^2+y^2}, \frac{2y}{1+x^2+y^2}, \frac{-1+x^2+y^2}{1+x^2+y^2} \right).$$

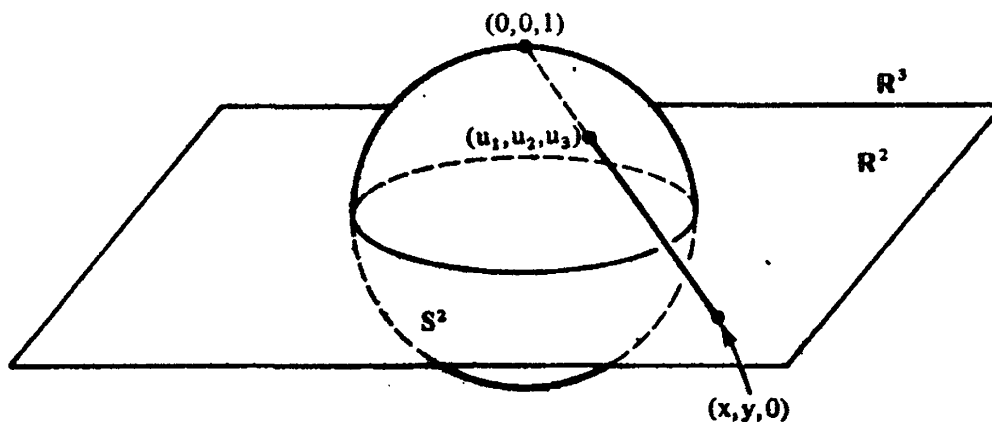

Figure 17.20

(c) *The Generator of $H^2(CP^1)$.*

By pulling the generator σ in $H^2(S^2)$ back to CP^1 we obtain a generator $g^*\sigma$ in $H^2(CP^1)$. It follows from (17.23.1) and (17.23.2) that in the appropriate coordinate patch,

$$g^*\sigma = \frac{1}{4\pi} \frac{du_1 du_2}{u_3},$$

where

$$u_1 = \frac{2x}{1+x^2+y^2}, \quad u_2 = \frac{2y}{1+x^2+y^2}, \quad \text{and} \quad u_3 = \frac{-1+x^2+y^2}{1+x^2+y^2}.$$

In terms of $z = x + iy$, the form $g^*\sigma$ can be written as

$$g^*\sigma = -\frac{1}{\pi} \frac{dx dy}{(1+x^2+y^2)^2} = -\frac{i}{2\pi} \frac{dz d\bar{z}}{(1+|z|^2)^2}.$$

By convention the standard orientation on CP^1 is given locally by $dx dy$. Therefore the positive generator in $H^2(CP^1)$ is

$$\alpha = -g^*\sigma = \frac{i}{2\pi} \frac{dz d\bar{z}}{(1 + |z|^2)^2}.$$

Since $z = z_0/z_1$, in terms of the homogeneous coordinates,

$$(17.23.3) \quad \alpha = \frac{i}{2\pi} \frac{(z_1 dz_0 - z_0 dz_1)(\bar{z}_1 d\bar{z}_0 - \bar{z}_0 d\bar{z}_1)}{(|z_0|^2 + |z_1|^2)^2}.$$

REMARK. If S^2 and CP^1 are given their respective standard orientations, then the stereographic projection from S^2 to CP^1 is orientation-reversing.

(d) Finding an ω such that $f^*\alpha = d\omega$ on S^3 .

Let $z_0 = x_1 + ix_2$ and $z_1 = x_3 + ix_4$ be the coordinates on C^2 . Then the unit 3-sphere S^3 is defined by

$$|z_0|^2 + |z_1|^2 = x_1^2 + x_2^2 + x_3^2 + x_4^2 = 1.$$

Hence $\sum_{i=1}^4 x_i dx_i = 0$ on S^3 . By a straightforward computation, replacing z_0 and z_1 in (17.23.3) by the x_i 's, we find

$$f^*\alpha = \frac{1}{\pi} (dx_1 dx_2 + dx_3 dx_4) = \frac{1}{\pi} d(x_1 dx_2 + x_3 dx_4).$$

Therefore, we may take ω to be

$$\omega = \frac{1}{\pi} (x_1 dx_2 + x_3 dx_4).$$

(e) Computing the Integral.

The Hopf invariant of the Hopf fibration is

$$\begin{aligned} H(f) &= \int_{S^3} \omega \wedge d\omega \\ &= \frac{1}{\pi^2} \int_{S^3} x_1 dx_2 dx_3 dx_4 + x_3 dx_1 dx_2 dx_4 \\ &= \frac{2}{\pi^2} \int_{S^3} x_1 dx_2 dx_3 dx_4 \quad \text{by symmetry.} \end{aligned}$$

Using spherical coordinates,

$$x_1 = \sin \xi \sin \phi \cos \theta,$$

$$x_2 = \sin \xi \sin \phi \sin \theta,$$

$$x_3 = \sin \xi \cos \phi,$$

$$x_4 = \cos \xi,$$

where $0 \leq \xi \leq \pi$, $0 \leq \phi \leq \pi$, and $0 \leq \theta \leq 2\pi$, the integral becomes

$$\begin{aligned} \int_{S^3} x_1 dx_2 dx_3 dx_4 &= \int_0^\pi \int_0^\pi \int_0^{2\pi} \sin^4 \xi \sin^3 \phi \cos^2 \theta d\theta d\phi d\xi \\ &= \pi^2/2. \end{aligned}$$

Therefore, the Hopf invariant of f is 1.

This Hopf invariant may also be found geometrically, for by identifying $S^3 - \{\text{north pole}\}$ with \mathbb{R}^3 via the stereographic projection, it is possible to visualize the fibers of the Hopf fibration

$$\begin{array}{c} S^1 \rightarrow S^3 \\ \downarrow \\ S^2 = \mathbb{C}P^1 \end{array}$$

and to compute the linking number of two fibers. We let $z_0 = x_1 + ix_2$, $z_1 = x_3 + ix_4$. Then the stereographic projection

$$p: S^3 - \{(0, 0, 0, 1)\} \rightarrow \mathbb{R}^3 = \{x_4 = 0\}$$

is given by

$$(x_1, x_2, x_3, x_4) \mapsto \left(\frac{x_1}{1-x_4}, \frac{x_2}{1-x_4}, \frac{x_3}{1-x_4} \right)$$

This we see as follows. The line through the north pole $(0, 0, 0, 1)$ and the point (x_1, x_2, x_3, x_4) has parametric equation $(0, 0, 0, 1) + t(x_1, x_2, x_3, x_4 - 1)$. It intersects $\mathbb{R}^3 = \{x_4 = 0\}$ at $t = 1/(1-x_4)$, so the intersection point is

$$\left(\frac{x_1}{1-x_4}, \frac{x_2}{1-x_4}, \frac{x_3}{1-x_4}, 0 \right).$$

See Figure 17.21.

Note that the fiber S_∞ of the Hopf fibration over $[1, 0] \in \mathbb{C}P^1$ is $\{(z_0, 0) \in \mathbb{C}^2 \mid |z_0| = 1\}$ and the fiber S_0 over $[0, 1]$ is $\{(0, 0, \cos \theta, \sin \theta) \in \mathbb{R}^4, 0 \leq \theta \leq 2\pi\}$, both oriented counterclockwise in their planes. So via the stereographic projection S_∞ corresponds to the unit circle in the (x_1, x_2) -plane while S_0 corresponds to $\{(0, 0, \cos \theta/1 - \sin \theta), 0 \leq \theta \leq 2\pi\}$, which is the x_3 -axis with its usual orientation. Therefore the linking number

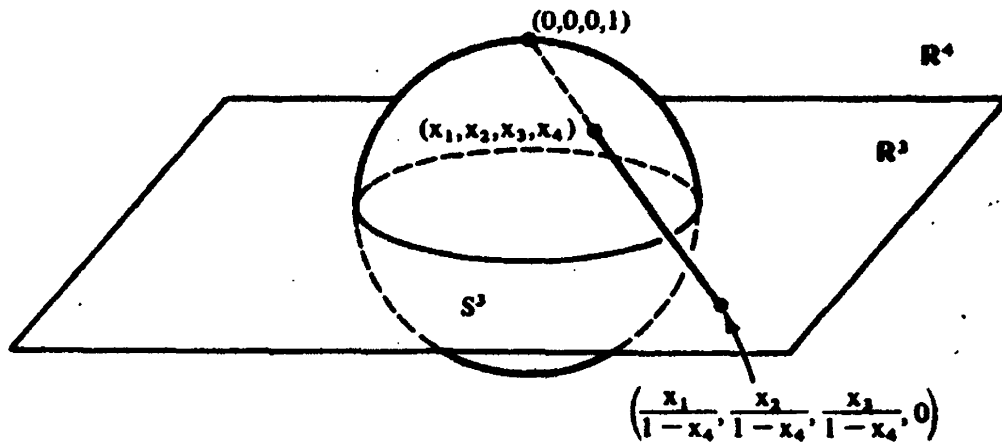

Figure 17.21

of S_∞ and S_0 is 1. By the geometric interpretation of the Hopf invariant as a linking number, the Hopf invariant of the Hopf fibration is 1.

Exercise 17.24. (a) Given an integer q , show that for $n \geq q + 2$, the natural inclusion $O(n) \hookrightarrow O(n + 1)$ induces an isomorphism $\pi_q(O(n)) \simeq \pi_q(O(n + 1))$. For n sufficiently large, the homotopy group $\pi_q(O(n))$ is therefore independent of n and we can write $\pi_q(O)$. This is the q -th *stable homotopy group* of the orthogonal group.

(b) Given integers k and q , show that for $n \geq k + q + 2$,

$$\pi_q(O(n)/O(n - k)) = 0.$$

(c) Similarly, use the fiber bundle of $S^{2n+1} = U(n + 1)/U(n)$ to show that for $2n \geq q + 1$, the inclusion $U(n) \hookrightarrow U(n + 1)$ induces an isomorphism

$$\pi_q(U(n)) \simeq \pi_q(U(n + 1)).$$

Deduce that for $n \geq (2k + q + 1)/2$,

$$\pi_q(U(n)/U(n - k)) = 0.$$

§18 Applications to Homotopy Theory

The Leray spectral sequence is basically a tool for computing the homology or cohomology of a fibration. However, since by the Hurewicz isomorphism theorem, the first nontrivial homology of the Eilenberg-MacLane space $K(\pi_q(X), n)$ is $\pi_q(X)$, if one can fit the Eilenberg-MacLane spaces $K(\pi_q(X), n)$ into a fibering, it may be possible to apply the spectral sequence to compute the homotopy groups. Such fiberings are provided by the Postnikov approximation and the Whitehead tower, two twisted products of Eilenberg-

MacLane spaces which in some way approximate a given space in homotopy. As examples of how this works, we compute in this section $\pi_4(S^3)$ and $\pi_5(S^3)$.

Eilenberg-MacLane Spaces

Let A be a group. A path-connected space Y is an *Eilenberg-MacLane space* $K(A, n)$ if

$$\pi_q(Y) = \begin{cases} A & \text{in dimension } n \\ 0 & \text{otherwise.} \end{cases}$$

(We do not consider π_0 unless otherwise indicated.) For any group A and any integer $n \geq 1$ (with the obvious restriction that A be Abelian if $n > 1$), it can be shown that in the category of *CW* complexes such a space exists and is unique up to homotopy equivalence (Spanier [1, Chap. 8, Sec. 1, Cor. 5, p. 426] and Mosher and Tangora [1, Cor. 2, p. 3]). So provided we consider only *CW* complexes, the symbol $K(A, n)$ is unambiguous.

EXAMPLE 18.1. (a) Since $\pi : \mathbb{R}^1 \rightarrow S^1$ given by

$$\pi(x) = e^{2\pi i x}$$

is a covering space, $\pi_q(S^1) = \pi_q(\mathbb{R}^1) = 0$ for $q \geq 2$ by (17.5). Therefore the circle is a $K(\mathbb{Z}, 1)$.

(b) If F is a free group, then $K(F, 1)$ is a bouquet of circles, one for each generator (Figure 18.1).

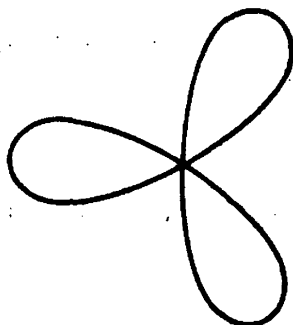

Figure 18.1

(c) The fundamental group of a Riemann surface S of genus $g \geq 1$ (Figure 18.2) is a group π with generators $a_1, b_1, \dots, a_g, b_g$ and a single relation

$$a_1 b_1 a_1^{-1} b_1^{-1} \cdots a_g b_g a_g^{-1} b_g^{-1} = 1.$$

By the uniformization theorem of complex function theory the universal cover of a Riemann surface of genus $g \geq 1$ is contractible. Hence the Riemann surface S is the Eilenberg-MacLane space $K(\pi, 1)$.

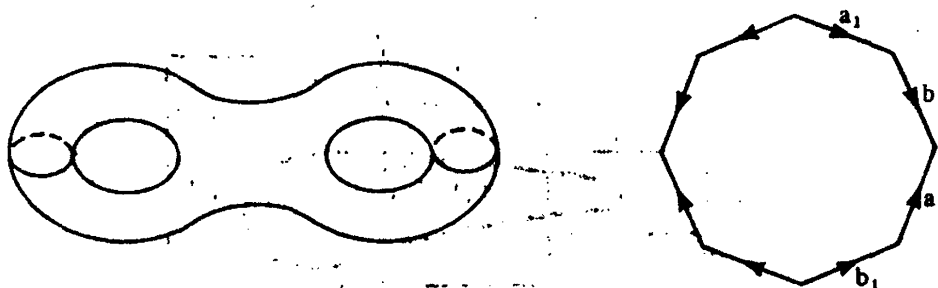

Figure 18.2

(d) By Proposition 17.2, we see that $\Omega K(A, n) = K(A, n - 1)$.

(e) The Eilenberg-MacLane space $K(Z, n)$ may be constructed from the sphere S^n by killing all $\pi_q(S^n)$ for $q > n$. The procedure for killing homotopy groups is discussed in the section on Postnikov approximation.

(f) By (17.1.a) if A and B are two groups, then

$$K(A, n) \times K(B, n) = K(A \times B, n).$$

The Telescoping Construction

In this section we give a technique for constructing certain Eilenberg-MacLane spaces, called the *telescoping construction*. It is best illustrated with examples.

EXAMPLE 18.2 (The infinite real projective space). The real projective space RP^n is defined as the quotient of the sphere S^n under the equivalence relation which identifies the antipodal points of S^n . There is a natural sequence of inclusions

$$\{\text{point}\} \hookrightarrow \cdots \hookrightarrow RP^n \hookrightarrow RP^{n+1} \hookrightarrow \cdots$$

We define the infinite real projective space RP^∞ by gluing together via the natural inclusions all the finite real projective spaces

$$RP^\infty = \coprod RP^n \times I / (x, 1) \sim (i(x), 0).$$

Pictorially RP^∞ looks like an infinite telescope (Figure 18.3).

Since $S^n \rightarrow RP^n$ is a double cover, by (17.5) $\pi_q(RP^n) = \pi_q(S^n) = 0$ for $1 < q < n$. We now show that RP^∞ has no higher homotopy, i.e., $\pi_q(RP^\infty) = 0$ for $q > 1$. Take $\pi_{15}(RP^\infty)$ for example. Suppose $f : S^{15} \rightarrow RP^\infty$ represents an element of $\pi_{15}(RP^\infty)$. Since the image $f(S^{15})$ is compact, it must lie in a finite union of the $RP^n \times I$'s above. We can slide $f(S^{15})$ into a high $RP^n \times I$. If $n > 15$, then $f(S^{15})$ will be contractible. Therefore $\pi_{15}(RP^\infty) = 0$. Thus by sliding the image of a sphere into a high enough projective space, we see that this telescope kills all higher homotopy groups.

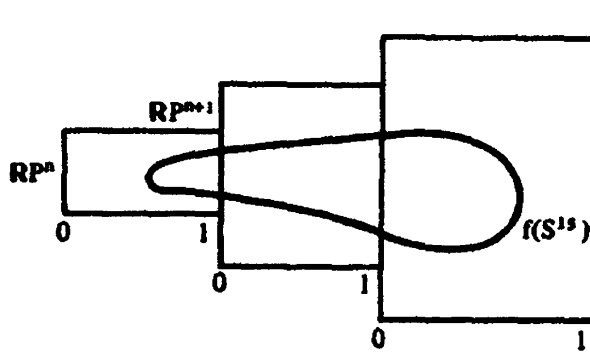

Figure 18.3

Applying the telescoping construction to the sequence of spheres

$$\{\text{point}\} \hookrightarrow \cdots \hookrightarrow S^n \hookrightarrow S^{n+1} \hookrightarrow \cdots$$

we obtain the infinite sphere

$$S^\infty = \coprod_n S^n \times I / (x, 1) \sim (i(x), 0).$$

It is a double cover of RP^∞ . By the same reasoning as above, S^∞ has no homotopy in any dimension. Therefore $\pi_1(RP^\infty) = \mathbb{Z}_2$. This proves that RP^∞ is a $K(\mathbb{Z}_2, 1)$.

EXAMPLE 18.3. (The infinite complex projective space). Applying the telescoping construction to the sequences

$$\begin{array}{ccccccc} \cdots & \subset & S^{2n+1} & \subset & S^{2n+3} & \subset & \cdots \\ & & S^1 \downarrow & & \downarrow & & \\ \cdots & \subset & CP^n & \subset & CP^{n+1} & \subset & \cdots \end{array}$$

we obtain the fibering

$$(18.3.1) \quad \begin{array}{ccc} S^1 & \rightarrow & S^\infty \\ & & \downarrow \\ & & CP^\infty \end{array}$$

where CP^∞ is gotten by gluing together the CP^n 's as in the previous example. Since S^∞ has no homotopy in any dimension, it follows from the homotopy sequence of the fibering that

$$\pi_k(CP^\infty) = \begin{cases} \mathbb{Z} & \text{when } k = 2 \\ 0 & \text{otherwise.} \end{cases}$$

Therefore CP^∞ is a $K(\mathbb{Z}, 2)$.

Exercise 18.4. By the Hurewicz isomorphism theorem $H_k(S^\infty) = 0$ except in dimension 0. Apply the spectral sequence of the fibering (18.3.1) to show

that the cohomology ring of CP^∞ is a polynomial algebra with a generator in dimension 2:

$$H^*(CP^\infty) = Z[x], \quad \dim x = 2.$$

EXAMPLE 18.5 (Lens spaces). Let S^{2n+1} be the unit sphere in C^{n+1} . Since S^1 acts freely on S^{2n+1} , so does any subgroup of S^1 . For example, Z_5 acts on S^{2n+1} by

$$e^{2\pi i/5} : (z_0, \dots, z_n) \mapsto (e^{2\pi i/5} z_0, \dots, e^{2\pi i/5} z_n).$$

The quotient space of S^{2n+1} by the action of Z_5 is the *Lens space* $L(n, 5)$. Applying the telescoping construction

$$\begin{array}{ccccccc} S^1 & \subset & \dots & \subset & S^{2n+1} & \subset & S^{2n+3} & \subset & \dots \\ Z_5 \downarrow & & & & \downarrow & & \downarrow & & \\ L(0, 5) & \subset & \dots & \subset & L(n, 5) & \subset & L(n+1, 5) & \subset & \dots \end{array}$$

we obtain a five-sheeted covering

$$\begin{array}{c} Z_5 \rightarrow S^\infty \\ \downarrow \\ L(\infty, 5). \end{array}$$

Hence

$$\pi_k(L(\infty, 5)) = \begin{cases} Z_5 & \text{if } k = 1 \\ 0 & \text{if } k > 1. \end{cases}$$

So the infinite Lens space $L(\infty, 5)$ is a $K(Z_5, 1)$. In exactly the same manner we can construct $L(\infty, q) = K(Z_q, 1)$ for any positive integer q .

REMARK 18.5.1. The Lens space $L(n, 2)$ is the real projective space RP^{2n+1} , and the infinite Lens space $L(\infty, 2)$ is RP^∞ .

Next we shall compute the cohomology of a Lens space, say $L(n, 5)$. Since the Lens space $L(n, 5)$ is not simply connected, the defining fibration $Z_5 \rightarrow S^{2n+1} \rightarrow L(n, 5)$ is of little use in the computation of the cohomology. Instead, note that the free action of S^1 on S^{2n+1} descends to an action on $L(n, 5)$:

$$(z_0, \dots, z_n) \mapsto (\lambda z_0, \dots, \lambda z_n), \quad \lambda \in S^1 \subset C^*$$

with quotient CP^n , so that there is a fiber bundle

$$\begin{array}{c} S^1 \rightarrow L(n, 5) \\ \pi_L \downarrow \\ CP^n. \end{array}$$

Exercise 18.8. Let q be a positive integer greater than one.

(a) Show that the integer cohomology of $K(\mathbb{Z}_q, 1)$ is

$$H^*(K(\mathbb{Z}_q, 1); \mathbb{Z}) = \begin{cases} \mathbb{Z} & \text{in dimension 0} \\ \mathbb{Z}_q & \text{in every positive even dimension} \\ 0 & \text{otherwise.} \end{cases}$$

(b) Using the fibering $S^1 \rightarrow K(\mathbb{Z}_q, 1) \rightarrow \mathbb{C}P^\infty$, compute $H^*(K(\mathbb{Z}_q, 1); \mathbb{Z}_p)$ where p is a prime.

Exercise 18.9. Let n and q be positive integers. Show that

$$H^*(K(\mathbb{Z}_q, n); \mathbb{Q}) = \begin{cases} \mathbb{Q} & \text{in dimension 0} \\ 0 & \text{otherwise.} \end{cases}$$

Therefore, by the structure theorem for finitely generated Abelian groups, the rational cohomology of $K(A, n)$ is trivial for a finitely generated torsion Abelian group.

Exercise 18.10. Determine the product structures of $H^*(L(n, q))$, $H^*(K(\mathbb{Z}_q, 1))$, and $H^*(K(\mathbb{Z}_q, 1); \mathbb{Z}_p)$. In particular, show that

$$H^*(\mathbb{R}P^\infty) = \mathbb{Z}[a]/(2a, 2a^2, 2a^3, \dots), \quad \dim a = 2,$$

and

$$H^*(\mathbb{R}P^\infty; \mathbb{Z}_2) = \mathbb{Z}_2[x], \quad \dim x = 1.$$

The Cohomology of $K(\mathbb{Z}, 3)$

Since $\pi_q(S^3) = 0$ for $q < 3$ and $\pi_3(S^3) = \mathbb{Z}$, one may wonder if the sphere S^3 is a $K(\mathbb{Z}, 3)$. One way of deciding this is to compute the cohomology of $K(\mathbb{Z}, 3)$. We first observe that

$$\Omega K(\mathbb{Z}, 3) = K(\mathbb{Z}, 2) = \mathbb{C}P^\infty,$$

whose cohomology we know to be $\mathbb{Z}[x]$ from Exercise 18.4. Since by Remark 17.13, every CW complex has a good cover, we can apply the spectral sequence of the path fibration

$$\begin{array}{ccc} K(\mathbb{Z}, 2) & \rightarrow & PK(\mathbb{Z}, 3) \\ & & \downarrow \\ & & K(\mathbb{Z}, 3) \end{array}$$

to compute the cohomology of $K(\mathbb{Z}, 3)$.

By Leray's theorem with integer coefficients (15.11), the E_2 term of the spectral sequence is

$$E_2^{p,q} = H^p(K(\mathbb{Z}, 3)) \otimes H^q(\mathbb{C}P^\infty)$$

and its product structure is that of the tensor product of $H^*(K(Z, 3))$ and $H^*(CP^\infty)$.

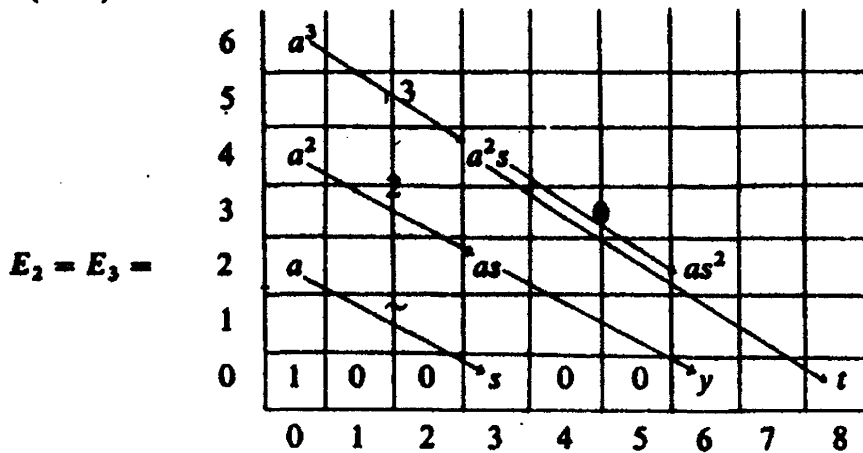

Since the total space $PK(Z, 3)$ is contractible, the E_∞ term is 0 except for $E_\infty^{0,0}$. The plan now is to “create” elements in the bottom row of the E_2 picture which would sooner or later “kill off” all the nonzero elements of the spectral sequence. There can be no nonzero elements in the bottom row of columns 1 and 2, for any such element would survive to E_∞ . However there must be an element s in column 3 to kill off a . Thus

$$d_3 a = s$$

and

$$d_3(a^2) = 2ad_3 a = 2as.$$

There must be an element y in column 6 to kill off as for otherwise as would survive to E_∞ . Therefore $H^6(K(Z, 3)) \neq 0$. This proves that S^3 is not a $K(Z, 3)$. Equivalently, it shows the existence of nontrivial higher homotopy groups for S^3 . Later in this section we will compute π_4 and π_5 of S^3 .

As for the cohomology ring of $K(Z, 3)$, we can be more precise. First, note that $y = d(as) = (da) \cdot s = s^2$. From the picture of E_2 , it is clear that $H^6(K(Z, 3)) = Z_2$. Therefore, $2s^2 = 0$. Now a nonzero element in $E_2^{7,0} = H^7(K(Z, 3))$ can be killed only by a^3 under d_7 . Since $d_3(a^3) = 3a^2s \neq 0$, a^3 does not even live to E_4 . So $H^7(K(Z, 3)) = 0$. Since $d_3(a^2s) = 2as^2 = 0$, a^2s would live to E_∞ unless $d_5(a^2s) = t \neq 0$. In $E_4 = E_5$, a^2s generates the cyclic group Z_3 . Since t is the element that kills a^2s in E_5 , t is of order 3. In summary the first few cohomology groups of $K(Z, 3)$ are

(18.11)

q	0	1	2	3	4	5	6	7	8
H^q	Z	0	0	Z	0	0	Z_2	0	Z_3
generators	1			s			s^2		t

EXERCISE 18.12. Show that $H^*(K(Z, n); \mathbb{Q})$ is an exterior algebra on one generator of dimension n if n is odd and a polynomial algebra on one generator of dimension n if n is even. In either case we say that the cohomology of $K(Z, n)$ is *free on one generator* (see Section 19 for the definition of a free algebra).

The Transgression

Let $\pi : E \rightarrow X$ be a fibration with connected fiber F over a space with a good cover \mathcal{U} . In computing the differentials of the spectral sequence of E using what we have developed so far, one often encounters ambiguities which cannot be resolved without further clues. One such clue is knowledge of the *transgressive elements*. An element ω in

$$H^q(F) \hookrightarrow E_2^{0,q} = H^0(\mathcal{U}, \mathcal{X}^q(F))$$

is called *transgressive* if it lives to E_{q+1} ; that is,

$$d_2 \omega = d_3 \omega = \cdots = d_q \omega = 0.$$

An alternative characterization of a transgressive element is given in the following proposition, which we phrase in the language of differential forms. Of course by replacing forms with singular cochains, the proposition is equally true in the singular setting with arbitrary coefficients.

Proposition 18.13. *Let $\pi : E \rightarrow M$ be a fibration with fiber F in the differentiable category. An element ω in $H^q(F)$ is transgressive if it is the restriction of a global form ψ on E such that $d\psi = \pi^*\tau$ for some form τ on the base M .*

REMARK 18.13.1. Because π^* is injective and

$$\pi^*d\tau = dd\psi = 0,$$

we actually have

$$d\tau = 0,$$

so the form τ defines a cohomology class on M .

PROOF OF PROPOSITION 18.13. Let \mathcal{U} be a good cover of M . If ω is transgressive, then by (14.12) it can be extended to a cochain $\alpha = \alpha_0 + \cdots + \alpha_q$ in the double complex $C^*(\pi^{-1}\mathcal{U}, \Omega^*)$ such that $D\alpha = \pi^*\beta$ for some Čech cocycle β on M .

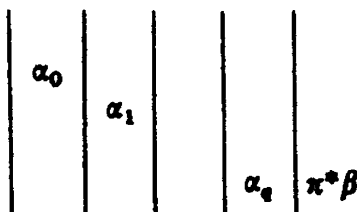

By the collating formula (9.5),

$$(*) \quad \psi = \sum_{i=0}^q (-1)^i (D''K)^i \alpha_i + (-1)^{q+1} K(D''K)^q \pi^* \beta$$

is a global form on E corresponding to α . From (*) we see that

$$d\psi = (-1)^{q+1} (D''K)^{q+1} \pi^* \beta = \pi^* \tau,$$

where $\tau = (-D''K)^{q+1} \beta$ is by (9.8) a closed global form on M .

Conversely suppose ψ is a global form on E with $d\psi = \pi^* \tau$. Then by restriction ψ defines a cochain in $C^0(\pi^{-1}U, \Omega^*)$ such that $D\psi = \pi^* \tau$.

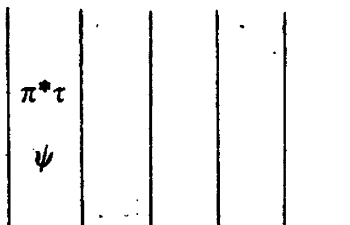

It is a simple exercise (analogous to Prop. 8.8) to show that ψ is D -cohomologous to a cochain α in $C^*(\pi^{-1}U, \Omega^*)$ such that $D\alpha = \pi^* \beta$ for some Čech cocycle β in $C^*(U, \Omega^*)$.

Exercise 18.13.2. Prove this assertion.

Let $\tilde{\psi}$ be the global form corresponding to α given by the collating formula (*). Then $\tilde{\psi}|_F = \psi|_F \in H^q(F)$ is transgressive. \square

We will now apply the singular analogue of Proposition 18.13 to obtain one of the most useful vanishing criteria for the differentials of a spectral sequence.

Proposition 18.14. *In mod 2 cohomology, if α is a transgressive, so is α^2 .*

PROOF. Let ψ be the singular cochain on E given by Prop. 18.13. Since ψ restricts to α on a fiber, ψ^2 restricts to α^2 . With Z_2 coefficients,

$$d(\psi^2) = 2\psi d\psi = 0.$$

Therefore, by Prop. 18.13 again, α^2 is transgressive. \square

Exercise 18.15. Compute $H^*(K(Z_2, 2); Z_2)$ and $H^*(K(Z_2, 2); Z)$ up to dimension 6.

Exercise 18.16. Compute $H^*(K(Z_2, 3); Z_2)$ and $H^*(K(Z_2, 3); Z)$ up to dimension 6.

Exercise 18.16.1. Compute the homology $H_*(K(Z_2, 4); Z)$ up to dimension 6.

Basic Tricks of the Trade

In homotopy theory every map $f : A \rightarrow B$ from a space A to a path-connected space B may be viewed as either an inclusion or a fibering. We can see this as follows.

(18.17) Inclusion

Applying the telescoping idea just once, we construct the *mapping cylinder* of f (see Figure 18.4):

$$M_f = (A \times I) \cup B / (a, 1) \sim f(a).$$

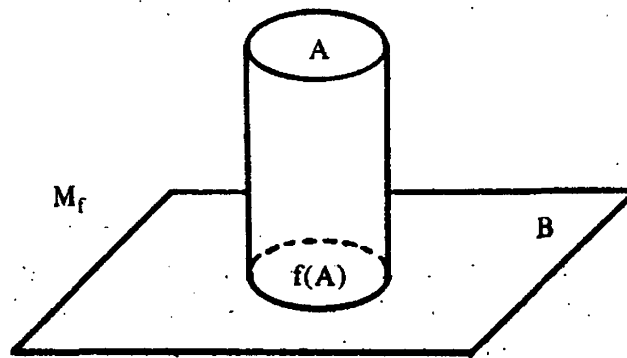
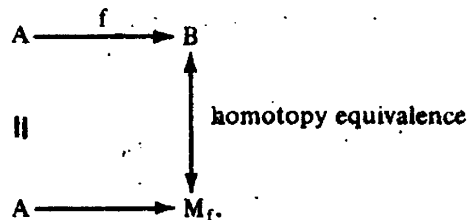

Figure 18.4

It is clear that the mapping cylinder M_f has the same homotopy type as B and that A is included in M_f . Indeed the following diagram is commutative:



(18.18) Fibering

Let $f : A \rightarrow B$ be any map, with B path connected. By (18.7) we may assume that f is an inclusion, i.e., A is a subspace of B (Figure 18.5). Define L to be the space of all paths in B with initial point in A . By shrinking every

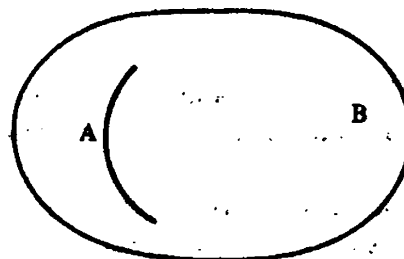

Figure 18.5

path to its initial point, we get a homotopy equivalence

$$L \simeq A.$$

On the other hand by projecting every path to its endpoint, we get a fibering

$$\begin{array}{c} \Omega_*^A \rightarrow L \simeq A \\ \downarrow \\ B \end{array}$$

whose fiber is Ω_*^A , the space of all paths from a point $*$ in B to A . So up to homotopy equivalence, $f : A \rightarrow B$ is a fibering.

Postnikov Approximation

Let X be a CW complex with homotopy groups $\pi_q(X) = \pi_q$. Although X has the same homotopy groups as the product space $\prod K(\pi_q, q)$, in general it will not have the same homotopy type as $\prod K(\pi_q, q)$. However, up to homotopy every CW complex can be thought of as a "twisted product" of Eilenberg-MacLane spaces in the following sense.

Proposition 18.19 (Postnikov Approximation). *Every connected CW complex can be approximated by a twisted product of Eilenberg-MacLane spaces; more precisely, for each n , there is a sequence of fibrations $Y_q \rightarrow Y_{q-1}$ with the $K(\pi_q, q)$'s as fibers and commuting maps $X \rightarrow Y_q$*

$$\begin{array}{ccccccc} & & K(\pi_2, 2) & & & & \\ & & \leftarrow & & \leftarrow & \cdots & \leftarrow \\ Y_1 & & Y_2 & & Y_3 & & Y_n \\ \parallel & & \swarrow & & \swarrow & & \uparrow \\ K(\pi_1, 1) & & & & & & X \end{array}$$

such that the map $X \rightarrow Y_q$ induces an isomorphism of homotopy groups in dimensions $\leq q - 1$.

Such a sequence of fibrations is called a *Postnikov tower* of X . In view of (18.18) that every map in homotopy theory is a fibration, this proposition is perhaps not so surprising.

We first explain a procedure for killing the homotopy groups of X above a given dimension. For example, to construct $K(\pi_1, 1)$ we kill off the homotopy groups of X in dimensions ≥ 2 as follows. If $\alpha : S^2 \rightarrow X$ represents a

nontrivial element in $\pi_2(X)$, we attach a 3-cell to X via α :

$$X \cup e^3 = X \amalg e^3/x \sim \alpha(x), \quad x \in e^3.$$

This procedure does not change the fundamental group of the space—by Proposition 17.11 attaching an n -cell to X could kill an element of $\pi_{n-1}(X)$ but does not affect the homotopy of X in dimensions $\leq n-2$. For each generator of $\pi_2(X)$ we attach a 3-cell to X as above. In this way we create a new space X_1 with the same fundamental group as X but with no π_2 . Iterating this procedure we can kill all higher homotopy groups. This gives Y_1 .

PROOF OF PROPOSITION 18.19. To construct Y_n we kill off all homotopy of X in dimensions $\geq n+1$ by attaching cells of dimensions $\geq n+2$. Then

$$\pi_k(Y_n) = \begin{cases} 0, & k \geq n+1 \\ \pi_k, & k = 1, 2, \dots, n. \end{cases}$$

Having constructed Y_n , the space Y_{n-1} is obtained from Y_n by killing the homotopy of Y_n in dimension n and above. By (18.18), the inclusions

$$X \subset Y_n \subset Y_{n-1} \subset \dots \subset Y_1$$

may be converted to fiberings. From the exact homotopy sequence of a fibering we see that the fiber of $Y_n \rightarrow Y_{n-1}$ is the Eilenberg-MacLane space $K(\pi_n, n)$. \square

Computation of $\pi_4(S^3)$

This computation of $\pi_4 = \pi_4(S^3)$ is based on the fact that the homotopy group π_4 appears as the first nontrivial homotopy group of the Eilenberg-MacLane space $K(\pi_4, 4)$. If this Eilenberg-MacLane space can be fitted into some fibering, its homotopy may be found from the spectral sequence. Such a fibering is provided by the Postnikov approximation.

Let Y_4 be a space whose homotopy agrees with S^3 up to and including dimension 4 and vanishes in higher dimensions. To get such a space we kill off all homotopy groups of S^3 in dimensions ≥ 5 by attaching cells of dimensions ≥ 6 . So

$$Y_4 = S^3 \cup e^6 \cup \dots$$

By Proposition 17.12, $H_4(Y_4) = H_5(Y_4) = 0$. The Postnikov approximation theorem gives us a fibering

$$K(\pi_4, 4) \rightarrow Y_4$$

$$\downarrow$$

$$K(\mathbb{Z}, 3).$$

The E^2 term of the homology spectral sequence of this fibering is

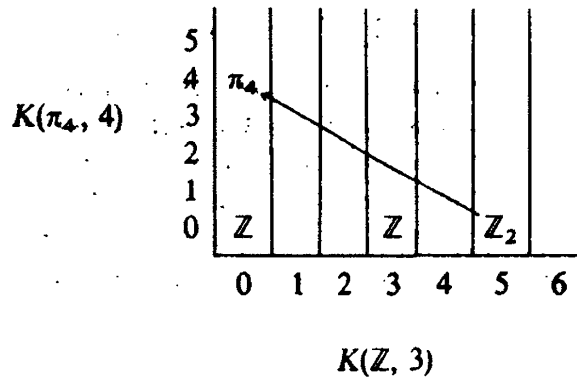

where the homology of $K(Z, 3)$ is obtained from (18.11) and the universal coefficient theorem (15.14). Since $H_4(Y_4) = H_5(Y_4) = 0$, the arrow shown must be an isomorphism. Hence $\pi_4(S^3) = Z_2$.

More generally since $Y_q = S^3 \cup e^{q+2} \cup \dots$, by (17.12),

$$H_q(Y_q) = H_{q+1}(Y_q) = 0.$$

Hence from the homology E^2 term of the fibration

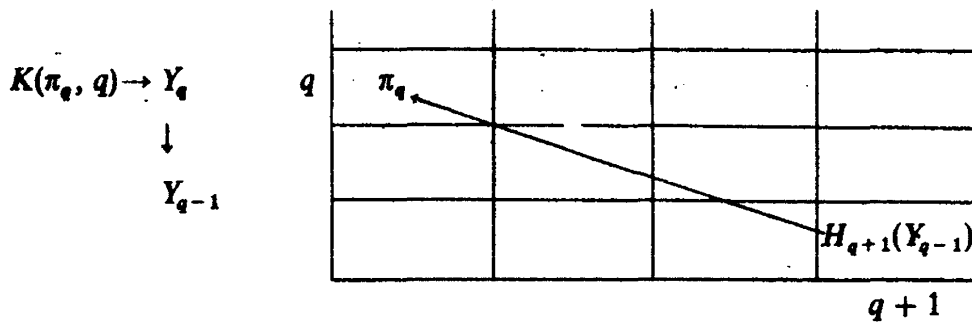

we get

$$(18.20) \quad \pi_q(S^3) = H_{q+1}(Y_{q-1}).$$

The Whitehead Tower

The Whitehead tower is a sequence of fibrations, dual to the Postnikov approximation in a certain sense, which generalizes the universal covering of a space. Unlike the Postnikov construction, where we kill successively the homotopy groups above a given dimension, here the idea is to kill at each stage all the homotopy groups below a given dimension.

Up to homotopy the universal covering of a space X may be constructed as follows. Write $\pi_q = \pi_q(X)$. By attaching cells to X we can kill all π_q for $q \geq 2$ as in (18.19). Let $Y = X \cup e^3 \cup \dots$ be the space so obtained; Y is a $K(\pi_1, 1)$ containing X as a subspace. Consider the space Ω_*^X of all paths in Y from a base point $*$ to X (Figure 18.6). The endpoint map: $\Omega_*^X \rightarrow X$ is a

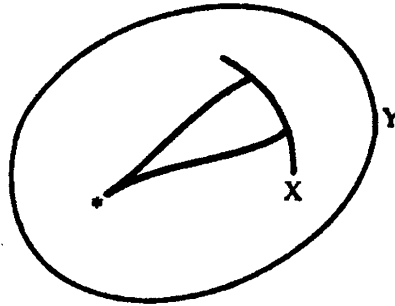

Figure 18.6

fibration with fiber $\Omega Y = \Omega K(\pi_1, 1) = K(\pi_1, 0)$. From the homotopy exact sequence of the fibering

$$\begin{array}{c} K(\pi_1, 0) \rightarrow \Omega_0^X \\ \downarrow \\ X \end{array}$$

we see that $\pi_1(\Omega_0^X) = 0$. Hence $X_1 = \Omega_0^X$ is the universal covering of X up to homotopy.

We will now generalize this procedure to obtain a sequence of fibrations

$$\begin{array}{c} \vdots \\ \downarrow \\ K(\pi_n, n-1) \rightarrow X_n \\ \downarrow \\ X_{n-1} \\ \downarrow \\ \vdots \\ \downarrow \\ K(\pi_1, 0) \rightarrow X_1 \\ \downarrow \\ X \end{array}$$

such that

- (a) X_n is n -connected, i.e., $\pi_q(X_n) = 0$ for all $q \leq n$;
- (b) above dimension n the homotopy groups of X_n and X agree;
- (c) the fiber of $X_n \rightarrow X_{n-1}$ is $K(\pi_n, n-1)$.

This is the *Whitehead tower* of X . To construct X_n from X_{n-1} , we first kill all $\pi_q(X_{n-1})$, $q \geq n+1$, by attaching cells to X_{n-1} . This gives a

$$K(\pi_n, n) = X_{n-1} \cup e^{n+2} \cup \dots$$

Next let $X_n = \Omega_*^{X_{n-1}}$ be the space of all paths in $K(\pi_n, n)$ from a base point $*$ to X_{n-1} . The endpoint map: $X_n \rightarrow X_{n-1}$ has fiber $\Omega K(\pi_n, n) = K(\pi_n, n-1)$. From the homotopy exact sequence of the fibering

$$\begin{array}{c} K(\pi_n, n-1) \rightarrow X_n \\ \downarrow \\ X_{n-1} \end{array}$$

it is readily checked that $\pi_q(X_n) = \pi_q(X_{n-1})$ for $q \geq n+1$; and $\pi_q(X_n) = 0$ for $q \leq n-2$; furthermore,

$$(18.21) \quad 0 \rightarrow \pi_n(X_n) \rightarrow \pi_n(X_{n-1}) \xrightarrow{\partial} \pi_{n-1}(\Omega K(\pi_n, n)) \rightarrow \pi_{n-1}(X_n) \rightarrow 0$$

is exact. Here $\pi_n(X_{n-1}) = \pi_n$ by the induction hypothesis, and the problem is to show that $\partial: \pi_n(X_{n-1}) \rightarrow \pi_{n-1}(\Omega K(\pi_n, n))$ is an isomorphism. Now the inclusion $X_{n-1} \subset K(\pi_n, n) = X_{n-1} \cup e^{n+2} \cup \dots$ induces by (17.11) an isomorphism

$$\pi_n(X_{n-1}) \simeq \pi_n(K(\pi_n, n)).$$

Moreover, the definition of the boundary map

$$\partial: \pi_n(X_{n-1}) \rightarrow \pi_{n-1}(\Omega K(\pi_n, n))$$

(see (17.4)) is precisely how $\pi_n(K(\pi_n, n))$ was identified with $\pi_{n-1}(\Omega K(\pi_n, n))$ in Proposition 17.2. Therefore ∂ is an isomorphism and $\pi_n(X_n) = \pi_{n-1}(X_n) = 0$ in (18.21). This completes the construction of the Whitehead tower.

As a first application of the Whitehead tower we will prove Serre's theorem on the homotopy groups of the spheres. We call a sphere S^n odd or even according to whether n is odd or even.

Theorem 18.22 (Serre). *The homotopy groups of an odd sphere S^n are torsion except in dimension n ; those of an even sphere S^n are torsion except in dimensions n and $2n-1$.*

PROOF. The essential facts to be used in this proof are the following:

(a) in the Whitehead tower of any space X , $\pi_{q+1}(X) = H_{q+1}(X; \mathbb{Q})$; hence,

$$\pi_{q+1}(X) \otimes \mathbb{Q} = H_{q+1}(X; \mathbb{Q});$$

(b) the rational cohomology ring of $K(\pi, n)$ is trivial for a torsion finitely generated Abelian group π and is free on one generator of dimension n for $\pi = \mathbb{Z}$ (Exercises 18.9 and 18.12).

Since S^n is $(n-1)$ -connected and $\pi_n(S^n) = \mathbb{Z}$, the Whitehead tower begins with

$$(18.22.1) \quad \begin{array}{c} K(\mathbb{Z}, n-1) \rightarrow X_n \\ \downarrow \\ S^n \end{array}$$

For the rest of this proof we write π_q for $\pi_q(S^n)$. First consider the case where n is odd. We will assume $n \geq 3$. Then the rational cohomology of $K(\mathbb{Z}, n-1)$ is a polynomial algebra on one generator of dimension $n-1$ and the cohomology spectral sequence of the fibration (18.22.1) has E_2 term

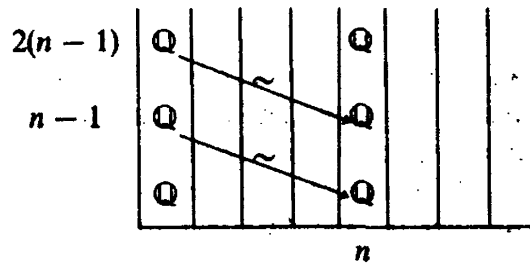

(Here we are using the *cohomology* spectral sequence to take advantage of the product structure.) The bottom arrow is an isomorphism because $H_{n-1}(X_n; \mathbb{Q}) = 0$; the other arrows are isomorphisms by the product structure. From the spectral sequence we see that X_n has trivial rational cohomology, hence trivial rational homology. By Remark (a) above, π_{n+1} is torsion. Now consider the next step of the Whitehead tower:

$$\begin{array}{c} K(\pi_{n+1}, n) \rightarrow X_{n+1} \\ \downarrow \\ X_n \end{array}$$

Since both X_n and $K(\pi_{n+1}, n)$ have trivial rational homology, so does X_{n+1} . By Remark (a) again, $\pi_{n+2} = H_{n+2}(X_{n+1})$ is torsion. By induction for all $q \geq n+1$, X_q has trivial rational homology and π_q is torsion.

Now suppose n is even. Then the rational cohomology of $K(\mathbb{Z}, n-1)$ is an exterior algebra and the E_2 term of the rational *homology* sequence of the fibration (18.22.1) has only four nonzero boxes:

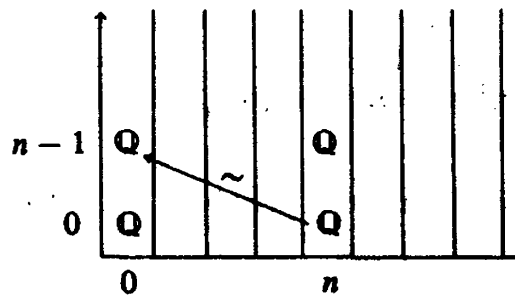

The arrow shown is an isomorphism because X_n is n -connected. So

$$H_*(X_n; \mathbb{Q}) \approx \begin{cases} \mathbb{Q} & \text{in dimensions } 0, 2n-1 \\ 0 & \text{otherwise.} \end{cases}$$

Suppose $n > 2$. Then $n+1 < 2n-1$. By Remark (a), $\pi_{n+1} = H_{n+1}(X_n)$ is

torsion. Since $H_*(K(\pi_{n+1}, n); \mathbb{Q})$ is trivial, from the fibration

$$\begin{array}{c} K(\pi_{n+1}, n) \rightarrow X_{n+1} \\ \downarrow \\ X_n \end{array}$$

we conclude that X_{n+1} has the same rational homology as X_n . This sets the induction going again, showing that π_q is torsion, until we hit $\pi_{2n-1} = H_{2n-1}(X_{2n-2})$, which is not torsion. In fact, π_{2n-1} has one infinite cyclic generator and possibly some torsion generators. At this point we may assume $n \geq 2$. By Remark (b), the rational cohomology ring

$$H^*(K(\pi_{2n-1}, 2n-2); \mathbb{Q})$$

is a polynomial algebra on one generator, so the cohomology E_2 term of the fibration

$$\begin{array}{c} K(\pi_{2n-1}, 2n-2) \rightarrow X_{2n-1} \\ \downarrow \\ X_{2n-2} \end{array}$$

is

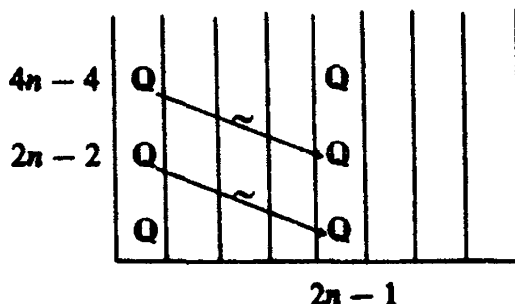

Since $H_{2n-1}(X_{2n-1}) = 0$, the arrows shown must all be isomorphisms. It follows that the rational cohomology groups of X_q are trivial for all $q > 2n - 1$ and the homotopy groups $\pi_q(S^n)$ are torsion for all $q > 2n - 1$. \square

Exercise 18.23. Give a proof of Theorem 18.22 based on the Postnikov approximation.

Computation of $\pi_5(S^3)$

If we try to compute $\pi_5(S^3)$ using the Postnikov approximation, we very quickly run up against an ambiguity in the spectral sequence. For by (18.20), $\pi_5(S^3) = H_6(Y_4)$, but to compute $H_6(Y_4)$ from the homology spectral

sequence of the fibering

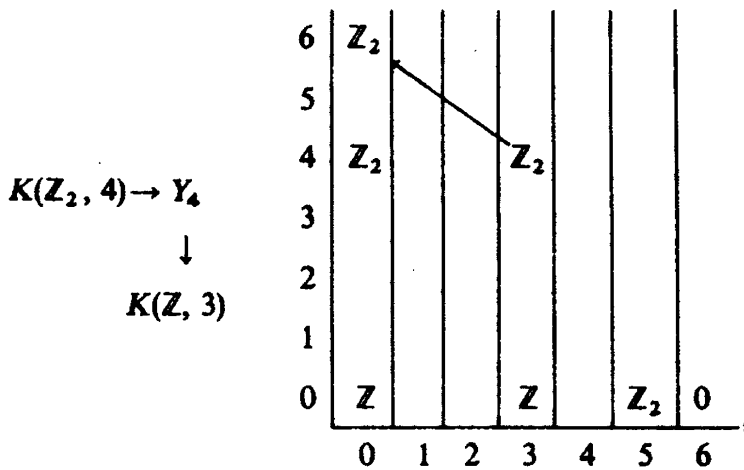

we will have to decide whether the arrow shown is the zero map or an isomorphism. With the tools at our disposal, this cannot be done. (For the homology of $K(\mathbb{Z}_2, 4)$ and $K(\mathbb{Z}, 3)$ see (18.16.1) and (18.11).)

In this case the Whitehead tower is more useful. Since S^3 is 2-connected, the Whitehead tower up to X_4 is

$$\begin{array}{c}
 K(\pi_4, 3) \rightarrow X_4 \\
 \downarrow \\
 K(\mathbb{Z}, 2) \rightarrow X_3 \\
 \downarrow \\
 S^3.
 \end{array}$$

From the construction of the Whitehead tower and the Hurewicz isomorphism, $\pi_3(S^3) = \pi_3(X_4) = H_3(X_4)$. So we can get π_3 by computing the homology of X_4 . This method also gives $\pi_4(S^3)$, which is $H_4(X_3)$.

The cohomology of X_3 may be computed from the spectral sequence of the fibration $K(\mathbb{Z}, 2) \rightarrow X_3 \rightarrow S^3$, whose E_2 term is

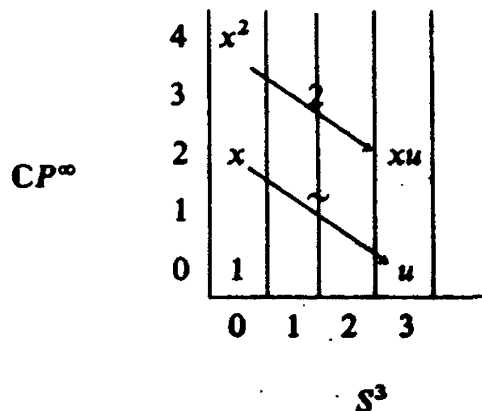

Since d_2 is clearly zero, $E_2 = E_3$. Next $d_3 : E_3^{0,2} \rightarrow E_3^{3,0}$ is an isomorphism because X_3 is 3-connected. By the antiderivation property of the differential d_3 , which we will write as d here,

$$d(x^n) = nx^{n-1} dx = nx^{n-1}u.$$

Hence the integral cohomology and homology of X_3 are

q	0	1	2	3	4	5	6	7	8	9	10	11
$H^q(X_3)$	\mathbb{Z}	0	0	0	0	\mathbb{Z}_2	0	\mathbb{Z}_3	0	\mathbb{Z}_4	0	\mathbb{Z}_5
$H_q(X_3)$	\mathbb{Z}	0	0	0	\mathbb{Z}_2	0	\mathbb{Z}_3	0	\mathbb{Z}_4	0	\mathbb{Z}_5	0

where the homology is obtained from the cohomology by the universal coefficient theorem (15.14.1).

The homology spectral sequence of the fibration $K(\pi_4, 3) \rightarrow X_4 \rightarrow X_3$ has E_2 term

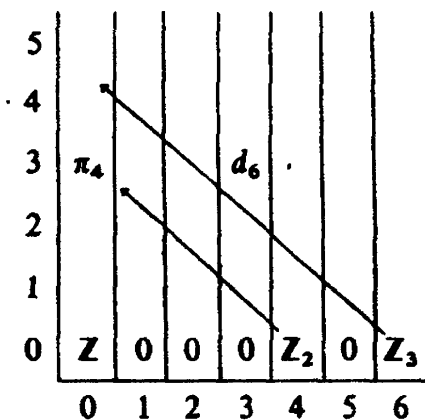

which shows that $\pi_4 = \mathbb{Z}_2$, since X_4 is 4-connected.

By Exercise 18.16, $H_4(K(\mathbb{Z}_2, 3)) = 0$ and $H_5(K(\mathbb{Z}_2, 3)) = \mathbb{Z}_2$. Since the only homomorphism from \mathbb{Z}_3 to \mathbb{Z}_2 is the zero map, d_6 in the diagram above is zero. Hence $H_5(X_4) = \mathbb{Z}_2$ and $\pi_5(S^3) = \pi_5(X_4) = H_5(X_4) = \mathbb{Z}_2$.

Exercise 18.24. Given a prime p , find the least q such that the homotopy group $\pi_q(S^3)$ has p -torsion.

§19 Rational Homotopy Theory

By some divine justice the homotopy groups of a finite polyhedron or a manifold seem as difficult to compute as they are easy to define. For a simple space like S^3 , already, the homotopy groups appear to be completely irregular. The computation of $\pi_4(S^3)$ and $\pi_5(S^3)$ in the preceding section should have given the reader some idea of the complexity that is involved.

However, if one is willing to forego the torsion information, by considering, for instance, the rational homotopy groups $\pi_*(X) \otimes \mathbb{Q}$, then some general theorems are possible. One such result is Serre's theorem on the homotopy groups of the spheres (Th. 18.22). In the late sixties Dennis Sullivan shed new light on the computation of rational homotopy by the use of differential forms. This section is a brief introduction to Sullivan's work. Although Sullivan's theory, with an appropriate definition of the rational differential forms, is applicable to CW complexes, we will consider only differentiable manifolds. As applications we derive again Serre's theorem and also compute some low-dimensional homotopy groups of the wedge $S^2 \vee S^2$.

Minimal Models

Let $A = \bigoplus_{i \geq 0} A^i$ be a differential graded commutative algebra over \mathbb{R} ; here the differential is an antiderivation of degree 1:

$$d(a \cdot b) = (da) \cdot b + (-1)^{\dim a} a \cdot db;$$

and the commutativity is in the graded sense:

$$a \cdot b = (-1)^{\dim a \cdot \dim b} b \cdot a.$$

In this section we will consider only finitely generated differential graded commutative algebras. Such an algebra is *free* if it satisfies no relations other than those of associativity and graded commutativity. We write $\Lambda(x_1, \dots, x_k)$ for the free algebra generated by x_1, \dots, x_k ; this algebra is the tensor product of the polynomial algebra on its even-dimensional generators and the exterior algebra on its odd-dimensional generators. An element in A is said to be *decomposable* if it is a sum of products of positive elements in A , i.e., $a \in A^+ \cdot A^+$, where $A^+ = \bigoplus_{i > 0} A^i$. A differential graded algebra \mathcal{M} is called a *minimal model* for A if:

- (a) \mathcal{M} is free;
- (b) there is a chain map $f: \mathcal{M} \rightarrow A$ which induces an isomorphism in cohomology;
- (c) the differential of a generator is either zero or decomposable (a differential graded algebra satisfying this condition is said to be *minimal*).

A minimal model of a manifold M is by definition a minimal model of its algebra of forms $\Omega^*(M)$.

Examples of Minimal Models

EXAMPLE 19.1. The de Rham cohomology of the odd sphere S^{2n-1} is an exterior algebra on one generator. Hence a minimal model for S^{2n-1} is $\Lambda(x)$,

$\dim x = 2n - 1$, with

$$f : x \mapsto \text{volume form on } S^{2n-1}.$$

EXAMPLE 19.2. The de Rham cohomology of the even sphere S^{2n} is $\mathbb{R}[a]/(a^2)$, $\dim a = 2n$. To construct a minimal model, we need a generator x in dimension $2n$ to map onto a and a generator y in dimension $4n - 1$ to kill off x^2 . Since $\dim y$ is odd, $y^2 = 0$. So the complex $\Lambda(x, y)$, $dx = 0$, $dy = x^2$ can be visualized as the array

$$\begin{array}{cccccc} 4n-1 & | & y & \xrightarrow{\quad} & xy & \xrightarrow{\quad} & x^2y & \xrightarrow{\quad} & x^3y & \xrightarrow{\quad} & x^4y \\ & & \searrow & & \searrow & & \searrow & & \searrow & & \searrow \\ & & 1 & \xrightarrow{\quad} & x & \xrightarrow{\quad} & x^2 & \xrightarrow{\quad} & x^3 & \xrightarrow{\quad} & x^4 \\ & & 0 & & 2n & & 4n & & 6n & & \end{array}$$

which shows that the cohomology of $\Lambda(x, y)$ is $\mathbb{R}[x]/(x^2)$. The minimal model of S^{2n} is $\Lambda(x, y)$, and the map $f : \Lambda(x, y) \rightarrow \Omega^*(S^{2n})$ is given by

$$\begin{aligned} f : x &\mapsto \text{volume form } \omega \text{ on } S^{2n} \\ y &\mapsto 0. \end{aligned}$$

EXAMPLE 19.3. Since the de Rham cohomology of the complex projective space CP^n is $\mathbb{R}[x]/(x^{n+1})$, $\dim x = 2$, by reasoning similar to the preceding example, a minimal model is $\Lambda(x, y)$, $\dim y = 2n + 1$, $dx = 0$, $dy = x^{n+1}$.

A differential graded algebra A is said to be 1-connected if $H^0(A) = \mathbb{R}$ and $H^1(A) = 0$.

Proposition 19A. *If the differential graded algebra A is 1-connected and has finite-dimensional cohomology, then it has a minimal model.*

PROOF. Let a_1, \dots, a_k be the 2-dimensional cycles in A which represent a basis of the second cohomology $H^2(A)$. Define $\mathcal{M}_2 = \Lambda(a_1, \dots, a_k)$, where $\dim a_i = 2$ and $da_i = 0$, and set

$$\begin{aligned} f : \mathcal{M}_2 &\rightarrow A \\ a_i &\mapsto a_i. \end{aligned}$$

At this stage f induces an isomorphism in cohomology in dimensions less than 3 and an injection in dimension 3, because $\Lambda(a_1, \dots, a_k)$ has nothing in dimension 3. We will prove inductively that for any n there is a minimal free algebra \mathcal{M}_n together with a chain map $f : \mathcal{M}_n \rightarrow A$ such that

- (a) the algebra \mathcal{M}_n has no elements in dimension 1 and no generators in dimensions greater than n ;
- (b) the map f induces an isomorphism in cohomology in dimensions less than $n + 1$ and an injection in dimension $n + 1$.

So suppose this is true for $n = q - 1$. By hypothesis there are exact sequences

$$0 \rightarrow H^q(\mathcal{M}_{q-1}) \rightarrow H^q(A) \rightarrow \text{coker } H^q(f) \rightarrow 0$$

and

$$0 \rightarrow \ker H^{q+1}(f) \rightarrow H^{q+1}(\mathcal{M}_{q-1}) \rightarrow H^{q+1}(A).$$

Let $\{[b_i]\}_{i \in I}$ be a basis of $\text{coker } H^q(f)$ and $\{[x_j]\}$ a basis of $\ker H^{q+1}(f)$, with b_i in A^q and x_j in \mathcal{M}_{q-1}^{q+1} , where \mathcal{M}_{q-1}^{q+1} denotes the elements of degree $q + 1$ in \mathcal{M}_{q-1} . The x_j 's are decomposable because the generators of \mathcal{M}_{q-1} are all of dimension $\leq q - 1$. The idea is to introduce new elements in \mathcal{M}_{q-1} to kill both $\text{coker } H^q(f)$ and $\ker H^{q+1}(f)$. Define

$$\mathcal{M}_q = \mathcal{M}_{q-1} \otimes \Lambda(b_i, \xi_j), \quad \dim b_i = \dim \xi_j = q.$$

\mathcal{M}_q is again a free minimal algebra, with differential

$$d(m \otimes 1) = (dm) \otimes 1,$$

$$d(1 \otimes b_i) = 0,$$

$$d(1 \otimes \xi_j) = x_j \otimes 1.$$

We extend $f: \mathcal{M}_{q-1} \rightarrow A$ to $f: \mathcal{M}_q \rightarrow A$ by

$$f(m \otimes 1) = f(m),$$

$$f(1 \otimes b_i) = b_i,$$

$$f(1 \otimes \xi_j) = \alpha_j,$$

where α_j is an element of A such that $f(x_j) = d\alpha_j$. It is easy to check that this new f is again a chain map.

We now show that $H^q(f): H^q(\mathcal{M}_q) \rightarrow H^q(A)$ is an isomorphism. Suppose

$$z = \sum v_k(m_k \otimes 1) + \sum \lambda_i(1 \otimes b_i) + \sum \mu_j(1 \otimes \xi_j)$$

is a cocycle in \mathcal{M}_q . Then

$$\sum v_k dm_k + \sum \mu_j x_j = 0.$$

Since the classes $[x_j]$ are linearly independent, all $\mu_j = 0$. If in addition $z \in \ker H^q(f)$, then

$$\sum v_k f(m_k) + \sum \lambda_i b_i = 0.$$

Since the $[b_i]$ form a basis of the cokernel of $H^q(f): H^q(\mathcal{M}_{q-1}) \rightarrow H^q(A)$, all $\lambda_i = 0$. Therefore, all the cocycles in \mathcal{M}_q that map to zero come from \mathcal{M}_{q-1} . By the induction hypothesis these cocycles are exact. This proves the injectivity. The surjectivity follows directly from the definition of the b_i .

Finally, because \mathcal{M}_{q-1} has nothing in dimension 1, the elements of dimension $q + 1$ in $\mathcal{M}_{q-1} \otimes \Lambda(b_i, \xi_j)$ all come from \mathcal{M}_{q-1} ; i.e.,

$\mathcal{M}_q^{q+1} = \mathcal{M}_{q-1}^{q+1} \otimes 1$. Hence $\ker H^{q+1}(f)$ is spanned by $x_j \otimes 1$. Since all of these elements are exact in \mathcal{M}_q (they are the differentials of $1 \otimes \xi_j$), $H^{q+1}(f)$ is injective. \square

The Main Theorem and Applications

We will not prove the main theorem stated below. For a discussion of the proof, see Sullivan [1] and [2] and Deligne, Griffiths, Morgan and Sullivan [1].

Theorem 19.5. *Let M be a simply connected manifold and \mathcal{M} its minimal model. Then the dimension of the vector space $\pi_q(M) \otimes \mathbb{Q}$ is the number of generators of the minimal model \mathcal{M} in dimension q .*

To make this theorem plausible, we will say a few words about the computation of the rational cohomology of M . The idea is to compute it from the Postnikov towers of M , whose fibers are the Eilenberg-MacLane spaces $K(\pi_q, q)$. Now there are two things to remember about the rational cohomology of $K(\pi_q, q)$:

- (a) a free summand \mathbb{Z} in π_q contributes a generator of dimension q to the rational cohomology $H^*(K(\pi_q, q); \mathbb{Q})$;
- (b) a finite summand in π_q contributes nothing.

In other words, the rational cohomology of $K(\pi_q, q)$ is a free algebra with as many generators as the rank of π_q (see 18.9 and 18.12). As far as the rational cohomology is concerned, then, the finite homotopy groups in the Postnikov towers have no effect. If the minimal model of M is to be built step by step out of its Postnikov towers, it makes sense that a generator appears in the model precisely when a rational homotopy element is involved. Hence it is not unreasonable that the dimension of the rational homotopy group $\pi_q(M) \otimes \mathbb{Q}$ is equal to the number of generators of the minimal model in dimension q . However, to make these arguments precise, considerable technical details remain to be resolved. In fact, at this writing there is no truly satisfactory exposition of rational homotopy theory available.

From this theorem and Examples 19.1 and 19.2 we have again Serre's result (18.22) that *the homotopy groups of an odd sphere S^n are torsion except in dimension n , where it is infinite cyclic; for an even sphere S^n , the exceptional dimensions are n and $2n - 1$.*

EXAMPLE 19.6. The *wedge* of the spheres S^n and S^m is the union of S^n and S^m with one point in common, written $S^n \vee S^m$. As an application of Sullivan's theory we will compute the ranks of the first few homotopy groups of $S^2 \vee S^2$. Since $S^2 \vee S^2$ has the same homotopy type as $\mathbb{R}^3 - P - Q$, where P

and Q are two distinct points of \mathbb{R}^3 , it suffices to construct a minimal model \mathcal{M} for $\Omega^*(\mathbb{R}^3 - P - Q)$.

At this stage we exploit the geometry of the situation to construct two closed 2-forms \bar{x} and \bar{y} on $\mathbb{R}^3 - P - Q$ that generate the cohomology $H_{DR}^*(\mathbb{R}^3 - P - Q)$ and that satisfy

$$\bar{x}^2 = \bar{x}\bar{y} = \bar{y}^2 = 0.$$

For this purpose choose small spheres S_P and S_Q about P and Q respectively. Let ω_P be a bump form of mass 1 concentrated near the north pole of S_P and let ω_Q be a similar form about the south pole of S_Q . The projection from P defines a natural map

$$\pi_P : \mathbb{R}^3 - P - Q \rightarrow S_P;$$

similarly the projection from Q defines a map

$$\pi_Q : \mathbb{R}^3 - P - Q \rightarrow S_Q.$$

Then

$$\bar{x} = \pi_P^* \omega_P \quad \text{and} \quad \bar{y} = \pi_Q^* \omega_Q$$

are easily seen to have the desired properties.

The minimal model is now constructed in a completely algebraic way as follows. First of all, the minimal model \mathcal{M} must have two generators x and y in dimension 2 mapping to \bar{x} and \bar{y} . To kill x^2 , xy , and y^2 , we need three generators a , b , c in dimension 3 with (see Figure 19.1)

$$da = x^2$$

$$db = xy$$

$$dc = y^2.$$

The map $f : \mathcal{M} \rightarrow \Omega^*(\mathbb{R}^3 - P - Q)$ up to this point is given by $x \mapsto \bar{x}$, $y \mapsto \bar{y}$, $a, b, c \mapsto 0$.

The differentials of the elements in dimension 5 are

$$d(ax) = x^3$$

$$d(ay) = x^2y$$

$$d(bx) = x^2y$$

$$d(by) = xy^2$$

$$d(cx) = xy^2$$

$$d(cy) = y^3.$$

Hence $d(ay - bx) = 0$ and $d(by - cx) = 0$. To kill these two closed forms,

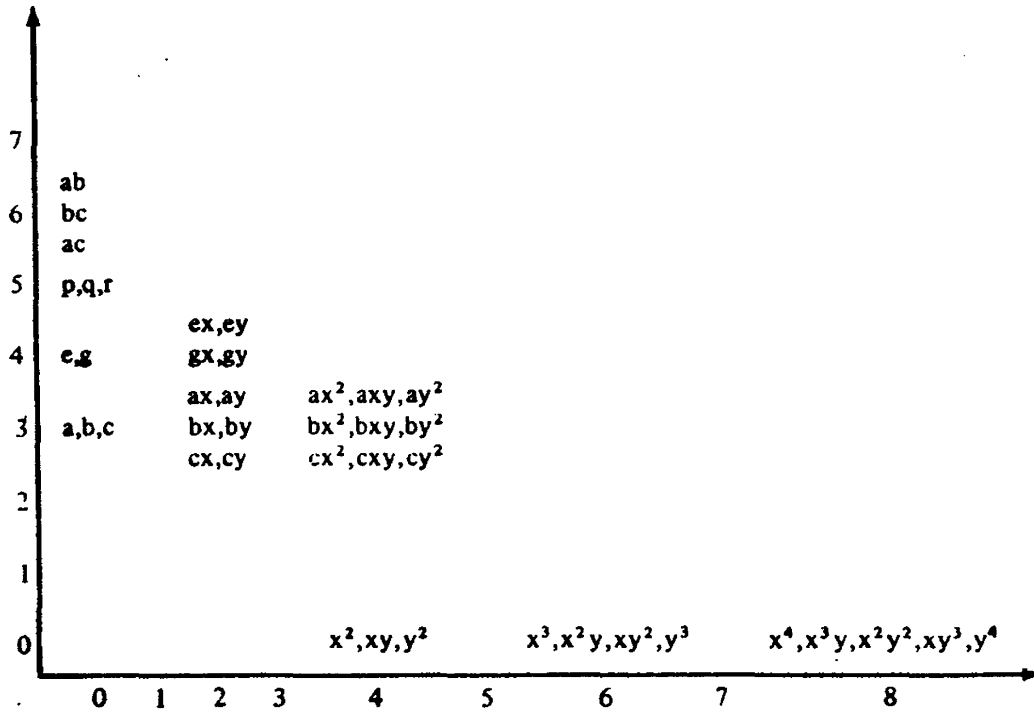

Figure 19.1

there must be two elements e and g in dimension 4 such that

$$de = ay - bx$$

$$dg = by - cx.$$

To find the generators in dimension 5 we need to know the closed forms in dimension 6. By looking at the differentials of all the elements in dimension 6:

$$d(ex) = axy - bx^2$$

$$d(ey) = ay^2 - bxy$$

$$d(gx) = bxy - cx^2$$

$$d(gy) = by^2 - cxy$$

$$d(ab) = bx^2 - axy$$

$$d(bc) = cxy - by^2$$

$$d(ac) = cx^2 - ay^2,$$

It is readily determined that $ex + ab$, $gy + bc$, and $ey + gx + ac$ are closed. Since the existing elements of dimension 5 do not map to these, we need three generators p , q , r in dimension 5 with

$$dp = ex + ab$$

$$dq = gy + bc$$

$$dr = ey + gx + ac.$$

The reader is invited to continue this process one step further and show that in dimension 6 there are six generators.

In summary the generators in dimensions ≤ 6 are

dim	2	3	4	5	6
generators	x, y	a, b, c	e, g	p, q, r	s, t, u, v, w, z

By Sullivan's theorem the rank of $\pi_q(S^2 \vee S^2)$ is

q	1	2	3	4	5	6
$\dim \pi_q(S^2 \vee S^2) \otimes \mathbb{Q}$	0	2	3	2	3	6

This agrees with Hilton's result on the homotopy groups of a wedge of spheres (Hilton [1]), since by Hilton's theorem

$$\begin{aligned} \pi_q(S^2 \vee S^2) &= \pi_q(S^2) + \pi_q(S^2) + \pi_q(S^3) + \pi_q(S^4) + \pi_q(S^4) \\ &+ \sum_{3 \text{ copies}} \pi_q(S^5) + \sum_{6 \text{ copies}} \pi_q(S^6) + \pi_q \text{ of spheres of dimension } \geq 7. \end{aligned}$$

CHAPTER IV.

Characteristic Classes

After the excursion into homotopy theory in the previous chapter, we return now to the differentiable category. Thus in this chapter, in the absence of explicit qualifications, all spaces are smooth manifolds, all maps are smooth maps, and $H^*(X)$ denotes the de Rham cohomology.

In Section 6 we first encountered the Euler class of a C^∞ oriented rank 2 vector bundle. It is but one of the many characteristic classes—that is, cohomology classes intrinsically associated to a vector bundle. In its modern form the theory of characteristic classes originated with Hopf, Stiefel, Whitney, Chern, and Pontrjagin. It has since found many applications to topology, differential geometry, and algebraic geometry.

In its most rudimentary form the point of view towards the Chern classes really goes back to the old Italian algebraic geometers, but in Section 20 we recast it along the ideas of Grothendieck. We introduce in Section 21 the computational and proof technique known as the splitting principle. This is followed by the Pontrjagin classes, which may be considered the real analogue of the Chern classes. We also include an application to the embedding of manifolds.

In the final section the Chern classes are shown to be the only complex characteristic classes in the following sense: any natural transformation from the complex vector bundles to the cohomology ring is a polynomial in the Chern classes. An added dividend is a classification theorem for complex vector bundles. With its aid we fulfill an earlier promise (see the remark following Prop. 11.9) to show that the vanishing of the Euler class of an oriented sphere bundle does not imply the existence of a section.

For the Euler class of a rank 2 bundle we had in (6.38) an explicit formula in terms of the patching data on the base manifold M . Elegant as the Grothendieck approach to the Chern classes is, it is not directly linked to the geometry of M , for it gives no such patching formulas. In the concluding remarks to this chapter we describe without proof a recipe for

constructing the Chern classes of a complex vector bundle $\pi: E \rightarrow M$ out of the transition functions of E and a partition of unity on M relative to some trivializing good cover for E .

§20 Chern Classes of a Complex Vector Bundle

In this section we will study the characteristic classes of a complex vector bundle. To begin with we define the first Chern class of a complex line bundle as the Euler class of its underlying real bundle. Applying the Leray-Hirsch theorem, we then compute the cohomology ring of the projectivization $P(E)$ of a complex vector bundle E and define the Chern classes of E in terms of the ring structure of $H^*(P(E))$. We conclude with a list of the main properties of the Chern classes.

The First Chern Class of a Complex Line Bundle

Recall that a complex vector bundle of rank n is a fiber bundle with fiber \mathbb{C}^n and structure group $GL(n, \mathbb{C})$. A complex vector bundle of rank 1 is also called a *complex line bundle*. Just as the structure group of a real vector bundle can be reduced to the orthogonal group $O(n)$, so by the Hermitian analogue of (6.4), the structure group of a rank n complex vector bundle can be reduced to the unitary group $U(n)$. Every complex vector bundle E of rank n has an underlying real vector bundle $E_{\mathbb{R}}$ of rank $2n$, obtained by discarding the complex structure on each fiber. By the isomorphism of $U(1)$ with $SO(2)$, this sets up a one-to-one correspondence between the complex line bundles and the oriented rank 2 real bundles. We define the *first Chern class* of a complex line bundle L over a manifold M to be the Euler class of its underlying real bundle $L_{\mathbb{R}}$: $c_1(L) = e(L_{\mathbb{R}}) \in H^2(M)$.

If L and L' are complex line bundles with transition functions $\{g_{\alpha\beta}\}$ and $\{g'_{\alpha\beta}\}$,

$$g_{\alpha\beta}, g'_{\alpha\beta}: U_{\alpha} \cap U_{\beta} \rightarrow \mathbb{C}^*,$$

then their tensor product $L \otimes L'$ is the complex line bundle with transition functions $\{g_{\alpha\beta} \cdot g'_{\alpha\beta}\}$. By the formula (6.38) which gives the Euler class in terms of the transition functions, we have

$$(20.1) \quad c_1(L \otimes L') = c_1(L) + c_1(L').$$

Let L^* be the dual of L . Since the line bundle $L \otimes L^* = \text{Hom}(L, L)$ has a nowhere vanishing section given by the identity map, $L \otimes L^*$ is a trivial bundle. By (20.1), $c_1(L) + c_1(L^*) = c_1(L \otimes L^*) = 0$. Therefore,

$$(20.2) \quad c_1(L^*) = -c_1(L).$$

EXAMPLE 20.3 (Tautological bundles on a projective space). Let V be a complex vector space of dimension n and $P(V)$ its projectivization:

$$P(V) = \{1\text{-dimensional subspaces of } V\}.$$

On $P(V)$ there are several God-given vector bundles: the product bundle $\hat{V} = P(V) \times V$, the *universal subbundle* S , which is the subbundle of \hat{V} defined by

$$S = \{(\ell, v) \in P(V) \times V \mid v \in \ell\},$$

and the *universal quotient bundle* Q , defined by the exact sequence

$$(20.4) \quad 0 \rightarrow S \rightarrow \hat{V} \rightarrow Q \rightarrow 0.$$

The fiber of S above each point ℓ in $P(V)$ consists of all the points in ℓ , where ℓ is viewed as a line in the vector space V . The sequence (20.4) is called the *tautological exact sequence* over $P(V)$, and S^* the *hyperplane bundle*.

Consider the composition

$$\sigma : S \hookrightarrow P(V) \times V \rightarrow V$$

of the inclusion followed by the projection. The inverse image of any point v is

$$\sigma^{-1}(v) = \{(\ell, v) \mid v \in \ell\}.$$

If $v \neq 0$, $\sigma^{-1}(v)$ consists of precisely one point (ℓ, v) where ℓ is the line through the origin and v ; if $v = 0$, then $\sigma^{-1}(0)$ is isomorphic to $P(V)$. Thus S may be obtained from V by separating all the lines through the origin in V . This map $\sigma : S \rightarrow V$ is called the *blow-up* or the *quadratic transformation* of V at the origin. Over the real numbers the blow-up of a plane may be pictured as the portion of a helicoid in Figure 20.1 with its top and bottom edges identified. Indeed, we may view the (x, y) -plane as being traced out by a horizontal line rotating about the origin. In order to separate these lines at the origin, we let the generating line move with constant velocity along the z -axis while it is rotating horizontally. The resulting surface in \mathbb{R}^3 is a helicoid.

We now compute the cohomology of $P(V)$. Endow V with a Hermitian metric and let E be the unit sphere bundle of the universal subbundle S :

$$E = \{(\ell, v) \mid v \in \ell, \|v\| = 1\}.$$

Note that $\sigma^{-1}(0)$ is the zero section of the universal subbundle S . Since $S - \sigma^{-1}(0)$ is diffeomorphic to $V - \{0\}$, we see that E is diffeomorphic to the sphere S^{2n-1} in V and that the map $\pi : E \rightarrow P(V)$ gives a fibering

$$S^1 \rightarrow S^{2n-1}$$

↓

$P(V)$.

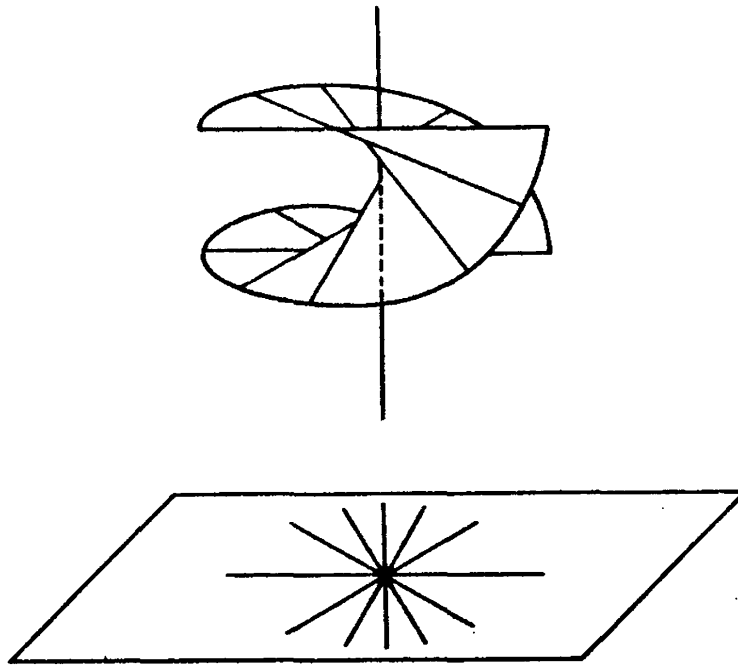

Figure 20.1

By a computation similar to (14.32), the cohomology ring $H^*(P(V))$ is seen to be generated by the Euler class of the circle bundle E , i.e., the first Chern class of the universal subbundle S . It is customary to take $x = c_1(S^*) = -c_1(S)$ to be the generator and write

$$(20.5) \quad H^*(P(V)) = \mathbb{R}[x]/(x^n), \quad \text{where } n = \dim_{\mathbb{C}} V.$$

We define the *Poincaré series* of a manifold M to be

$$P_f(M) = \sum_{i=0}^{\infty} \dim H^i(M) t^i.$$

By (20.5) the Poincaré series of the projective space $P(V)$ is

$$P_f(P(V)) = 1 + t^2 + \dots + t^{2(n-1)} = \frac{1 - t^{2n}}{1 - t^2}.$$

The Projectivization of a Vector Bundle

Let $\rho : E \rightarrow M$ be a complex vector bundle with transition functions $g_{\alpha\beta} : U_\alpha \cap U_\beta \rightarrow GL(n, \mathbb{C})$. We write E_p for the fiber over p and $PGL(n, \mathbb{C})$ for the projective general linear group $GL(n, \mathbb{C})/\{\text{scalar matrices}\}$. The *projectivization* of E , $\pi : P(E) \rightarrow M$, is by definition the fiber bundle whose fiber at a point p in M is the projective space $P(E_p)$ and whose transition functions $\bar{g}_{\alpha\beta} : U_\alpha \cap U_\beta \rightarrow PGL(n, \mathbb{C})$ are induced from $g_{\alpha\beta}$. Thus a point of $P(E)$ is a line ℓ_p in the fiber E_p .

As on the projectivization of a vector space, on $P(E)$ there are several

tautological bundles: the pullback $\pi^{-1}E$, the *universal subbundle* S , and the *universal quotient bundle* Q .

$$\begin{array}{ccc}
 0 \rightarrow S \rightarrow \pi^{-1}E \rightarrow Q \rightarrow 0 \\
 \downarrow \qquad \qquad \qquad \downarrow \rho \\
 P(E) \xrightarrow{\qquad \pi \qquad \qquad} M
 \end{array}$$

The pullback bundle $\pi^{-1}E$ is the vector bundle over $P(E)$ whose fiber at ℓ_p is E_p . When restricted to the fiber $\pi^{-1}(p)$ it becomes the trivial bundle,

$$\pi^{-1}E|_{P(E)_p} = P(E)_p \times E_p,$$

since $\rho : E_p \rightarrow \{p\}$ is a trivial bundle. The universal subbundle S over $P(E)$ is defined by

$$S = \{(\ell_p, v) \in \pi^{-1}E \mid v \in \ell_p\}.$$

Its fiber at ℓ_p consists of all the points in ℓ_p . The universal quotient bundle Q is determined by the tautological exact sequence

$$0 \rightarrow S \rightarrow \pi^{-1}E \rightarrow Q \rightarrow 0.$$

Set $x = c_1(S^*)$. Then x is a cohomology class in $H^2(P(E))$. Since the restriction of the universal subbundle S on $P(E)$ to a fiber $P(E)_p$ is the universal subbundle \tilde{S} of the projective space $P(E)_p$, by the naturality property of the first Chern class (6.39), it follows that $c_1(\tilde{S})$ is the restriction of x to $P(E)_p$. Hence the cohomology classes $1, x, \dots, x^{n-1}$ are global classes on $P(E)$ whose restrictions to each fiber $P(E)_p$ freely generate the cohomology of the fiber. By the Leray-Hirsch theorem (5.11) the cohomology $H^*(P(E))$ is a free module over $H^*(M)$ with basis $\{1, x, \dots, x^{n-1}\}$. So x^n can be written uniquely as a linear combination of $1, x, \dots, x^{n-1}$ with coefficients in $H^*(M)$; these coefficients are by definition the *Chern classes* of the complex vector bundle E :

$$(20.6) \quad x^n + c_1(E)x^{n-1} + \dots + c_n(E) = 0, \quad c_i(E) \in H^{2i}(M).$$

In this equation by $c_i(E)$ we really mean $\pi^*c_i(E)$. We call $c_i(E)$ the *ith Chern class* of E and

$$c(E) = 1 + c_1(E) + \dots + c_n(E) \in H^*(M)$$

its *total Chern class*. With this definition of the Chern classes, we see that the ring structure of the cohomology of $P(E)$ is given by

$$(20.7) \quad H^*(P(E)) = H^*(M)[x]/(x^n + c_1(E)x^{n-1} + \dots + c_n(E)),$$

where $x = c_1(S^*)$ and n is the rank of E . Since additively

$$H^*(P(E)) = H^*(M) \otimes H^*(P^{n-1}),$$

the Poincaré series of $P(E)$ is

$$(20.8) \quad P_t(P(E)) = P_t(M) \frac{1 - t^{2n}}{1 - t^2}.$$

We now have two definitions of the first Chern class of a line bundle L : as the Euler class of $L_{\mathbb{R}}$, and as a coefficient in (20.6). To check that these two definitions agree we will temporarily reserve the notation $c_1(\quad)$ for the second definition. What must be shown is that $e(L_{\mathbb{R}}) = c_1(L)$.

$$(20.9) \quad \begin{array}{ccc} \pi^{-1}L & & L \\ \downarrow & & \downarrow \\ P(L) & \xrightarrow{\pi} & M \end{array}$$

For a line bundle L , $P(L) = M$, $\pi^{-1}L = L$ and the universal subbundle S on $P(L)$ is L itself. Therefore, $x = e(S_{\mathbb{R}}^*) = -e(S_{\mathbb{R}}) = -e(L_{\mathbb{R}})$. So the relation (20.6) is $x + e(L_{\mathbb{R}}) = 0$, which proves that $c_1(L) = e(L_{\mathbb{R}})$.

If E is the trivial bundle $M \times V$ over M , then $P(E) = M \times P(V)$, so $x^n = 0$. Hence *all the Chern classes of a trivial bundle are zero. In this sense the Chern classes measure the twisting of a complex vector bundle.*

Main Properties of the Chern Classes

In this section we collect together some basic properties of the Chern classes.

(20.10.1) (Naturality) *If f is a map from Y to X and E is a complex vector bundle over X , then $c(f^{-1}E) = f^*c(E)$.*

$$\begin{array}{ccc} f^{-1}E & & E \\ \downarrow & & \downarrow \\ Y & \xrightarrow{f} & X \end{array}$$

PROOF. Basically this property follows from the functoriality of all the constructions in the definition of the Chern class. To be precise, by (6.39) the first Chern class of a line bundle is functorial. Write S_E for the universal subbundle over PE . Now $f^{-1}PE = P(f^{-1}E)$ and $f^{-1}S_E^* = S_{f^{-1}E}^*$, so if $x_E = c_1(S_E^*)$, then

$$x_{f^{-1}E} = c_1(S_{f^{-1}E}^*) = c_1(f^{-1}S_E^*) = f^*x_E.$$

Applying f^* to

$$x_E^n + c_1(E)x_E^{n-1} + \cdots + c_n(E) = 0,$$

we get

$$x_{f^{-1}E}^n + f^*c_1(E)x_{f^{-1}E}^{n-1} + \cdots + f^*c_n(E) = 0.$$

Hence

$$c_1(f^{-1}E) = f^*c_1(E). \quad \square$$

It follows from the naturality of the Chern class that if E and F are isomorphic vector bundles over X , then $c(E) = c(F)$.

(20.10.2) *Let V be a complex vector space. If S^* is the hyperplane bundle over $P(V)$, then $c_1(S^*)$ generates the algebra $H^*(P(V))$.*

This was proved earlier (20.5).

(20.10.3) (Whitney Product Formula) $c(E' \oplus E'') = c(E')c(E'')$.

The proof will be given in the next section.

In fact, these three properties uniquely characterize the Chern class (Hirzebruch [1, pp. 58–60]). For future reference we list below three more useful properties.

(20.10.4) *If E has rank n as a complex vector bundle, then $c_i(E) = 0$ for $i > n$.*

This is really a definition.

(20.10.5) *If E has a nonvanishing section, then the top Chern class $c_n(E)$ is zero.*

PROOF. Such a section s induces a section \tilde{s} of $P(E)$ as follows. At a point p in X , the value of \tilde{s} is the line in E_p through the origin and $s(p)$.

$$\begin{array}{c} P(E) \\ \tilde{s} \downarrow \pi \\ X \end{array}$$

Then $\tilde{s}^{-1}S_E$ is a line bundle over X whose fiber at p is the line in E_p spanned by $s(p)$. Since every line bundle with a nonvanishing section is isomorphic to the trivial bundle, we have the tautology

$$\tilde{s}^{-1}S_E \simeq \text{the trivial line bundle.}$$

It follows from the naturality of the Chern class that

$$\tilde{s}^*c_1(S_E) = 0,$$

which implies that

$$\tilde{s}^*x = 0.$$

Applying \tilde{s}^* to

$$x^n + c_1x^{n-1} + \cdots + c_n = 0,$$

we get

$$\tilde{s}^*c_n = 0.$$

By our abuse of notation this really means $\tilde{s}^*\pi^*c_n = 0$. Therefore $c_n = 0$. \square

(20.10.6) *The top Chern class of a complex vector bundle E is the Euler class of its realization:*

$$c_n(E) = e(E_{\mathbb{R}}), \quad \text{where } n = \text{rank } E.$$

This proposition will be proved in the next section after we have established the splitting principle.

§21 The Splitting Principle and Flag Manifolds

In this section we prove the Whitney product formula and compute a few Chern classes. The proof and the computations are based on the splitting principle, which, roughly speaking, states that if a polynomial identity in the Chern classes holds for direct sums of line bundles, then it holds for general vector bundles. In the course of establishing the splitting principle we introduce the flag manifolds. We conclude by computing the cohomology ring of a flag manifold.

The Splitting Principle

Let $\tau: E \rightarrow M$ be a C^∞ complex vector bundle of rank n over a manifold M . Our goal is to construct a space $F(E)$ and a map $\sigma: F(E) \rightarrow M$ such that:

- (1) the pullback of E to $F(E)$ splits into a direct sum of line bundles: $\sigma^{-1}E = L_1 \oplus \cdots \oplus L_n$;
- (2) σ^* embeds $H^*(M)$ in $H^*(F(E))$.

Such a space $F(E)$, which is in fact a manifold by construction, is called a *split manifold* of E .

If E has rank 1, there is nothing to prove.

If E has rank 2, we can take as a split manifold $F(E)$ the projective

bundle $P(E)$, for on $P(E)$ there is the exact sequence

$$0 \rightarrow S_E \rightarrow \sigma^{-1}E \rightarrow Q_E \rightarrow 0;$$

by the exercise below, $\sigma^{-1}E = S_E \oplus Q_E$, which is a direct sum of line bundles.

Exercise 21.1. Let $0 \rightarrow A \rightarrow B \rightarrow C \rightarrow 0$ be a short exact sequence of C^∞ complex vector bundles. Then B is isomorphic to $A \oplus C$ as C^∞ a bundle.

Now suppose E has rank 3. Over $P(E)$ the line bundle S_E splits off as before. The quotient bundle Q_E over $P(E)$ has rank 2 and so can be split into a direct sum of line bundles when pulled back to $P(Q_E)$.

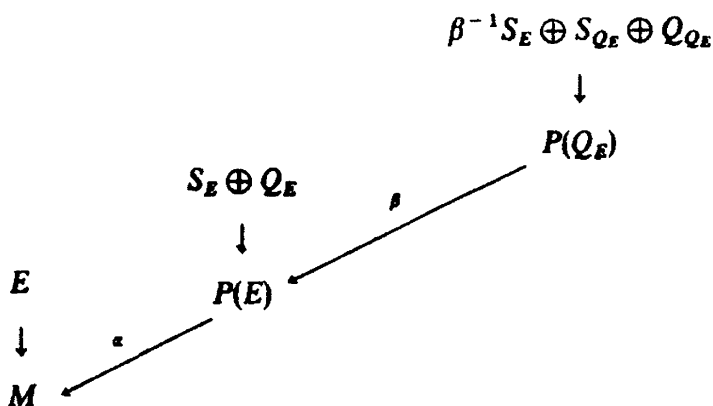

Thus we may take $P(Q_E)$ to be a split manifold $F(E)$. Let $x_1 = \beta^*c_1(S_E^*)$ and $x_2 = c_1(S_{Q_E}^*)$. By the result on the cohomology of a projective bundle (20.7),

$$H^*(F(E)) = H^*(M)[x_1, x_2]/(x_1^3 + c_1(E)x_1^2 + c_2(E)x_1 + c_3(E), x_2^2 + c_1(Q_E)x_2 + c_2(Q_E)).$$

The pattern is now clear; we split off one subbundle at a time by pulling back to the projectivization of a quotient bundle.

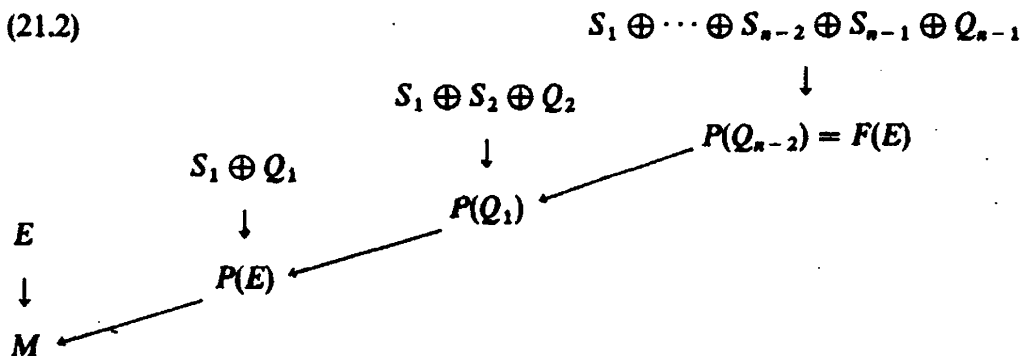

So for a bundle E of any rank n , a split manifold $F(E)$ exists and is given explicitly by (21.2). Its cohomology $H^*(F(E))$ is a free $H^*(M)$ -module having as a basis all monomials of the form

$$(21.3) \quad x_1^{a_1} x_2^{a_2} \cdots x_{n-1}^{a_{n-1}}, \quad a_1 \leq n-1, a_2 \leq n-2, \dots, a_{n-1} \leq 1, \\ a_1, \dots, a_{n-1} \text{ nonnegative,}$$

where $x_i = c_1(S_i^*)$ in the notation of the diagram.

More generally, by iterating the construction above we see that given any number of vector bundles E_1, \dots, E_r over M , there is a manifold N and a map $\sigma : N \rightarrow M$ such that the pullbacks of E_1, \dots, E_r to N are all direct sums of line bundles and that $H^*(M)$ injects into $H^*(N)$ under σ^* . The manifold N is a *split manifold* for E_1, \dots, E_r .

Because of the existence of the split manifolds we can formulate the following general principle

The Splitting Principle. *To prove a polynomial identity in the Chern classes of complex vector bundles, it suffices to prove it under the assumption that the vector bundles are direct sums of line bundles.*

For example, suppose we want to prove a certain polynomial relation $P(c(E), c(F), c(E \otimes F)) = 0$ for vector bundles E and F over a manifold M . Let $\sigma : N \rightarrow M$ be a split manifold for the pair E, F . By the naturality of the Chern classes

$$\sigma^* P(c(E), c(F), c(E \otimes F)) = P(c(\sigma^{-1}E), c(\sigma^{-1}F), c((\sigma^{-1}E) \otimes (\sigma^{-1}F))),$$

where $\sigma^{-1}E$ and $\sigma^{-1}F$ are direct sums of line bundles. So if the identity holds for direct sums of line bundles, then

$$\sigma^* P(c(E), c(F), c(E \otimes F)) = 0.$$

By the injectivity of $\sigma^* : H^*(M) \rightarrow H^*(N)$,

$$P(c(E), c(F), c(E \otimes F)) = 0.$$

In the next two subsections we give some illustrations of this principle.

Proof of the Whitney Product Formula and the Equality of the Top Chern Class and the Euler Class

We consider first the case of a direct sum of line bundles:

$$E = L_1 \oplus \cdots \oplus L_n.$$

By abuse of notation we write $\pi^{-1}E = L_1 \oplus \cdots \oplus L_n$ for the pullback of E

to the projectivization $P(E)$. Over $P(E)$, the universal subbundle S splits off from $\pi^{-1}E$.

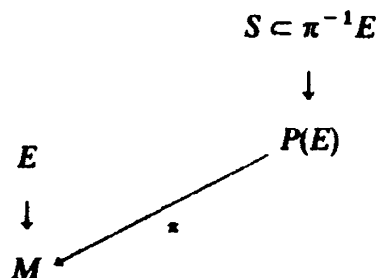

Let s_i be the projection of S onto L_i . Then s_i is a section of $\text{Hom}(S, L_i) = S^* \otimes L_i$. Since at every point y of $P(E)$, the fiber S_y is a 1-dimensional subspace of $(\pi^{-1}E)_y$, the projections s_1, \dots, s_n cannot be simultaneously zero. It follows that the open sets

$$U_i = \{y \in P(E) \mid s_i(y) \neq 0\}$$

form an open cover of $P(E)$. Over each U_i the bundle $(S^* \otimes L_i)|_{U_i}$ has a nowhere-vanishing section, namely s_i ; so $(S^* \otimes L_i)|_{U_i}$ is trivial. Let ξ_i be a closed global 2-form on $P(E)$ representing $c_1(S^* \otimes L_i)$. Then $\xi_i|_{U_i} = d\omega_i$ for some 1-form ω_i on U_i . The crux of the proof is to find a global form on $P(E)$ that represents $c_1(S^* \otimes L_i)$ and that vanishes on U_i ; because ω_i is not a global form on $P(E)$, $\xi_i - d\omega_i$ won't do. However, by shrinking the open cover $\{U_i\}$ slightly we can extend $\xi_i - d\omega_i$ to a global form. To be precise we will need the following lemmas.

Exercise 21.4 (The Shrinking Lemma). Let X be a normal topological space and $\{U_i\}_{i \in I}$ a finite open cover of X . Then there is an open cover $\{V_i\}_{i \in I}$ with

$$\bar{V}_i \subset U_i.$$

Exercise 21.5. Let M be a manifold, U an open subset, and A a closed subset contained in U . Then there is a C^∞ function f which is identically 1 on A and is 0 outside U .

It follows from these two lemmas that on $P(E)$ there exists an open cover $\{V_i\}$ and C^∞ functions ρ_i satisfying

- (a) $\bar{V}_i \subset U_i$
- (b) ρ_i is 1 on \bar{V}_i and is 0 outside U_i .

Now $\rho_i \omega_i$ is a global form which agrees with ω_i on V_i so that

$$\xi_i - d(\rho_i \omega_i)$$

is a global form representing $c_1(S^* \otimes L_i)$ and vanishing on V_i . In summary,

there is an open cover $\{V_i\}$ of $P(E)$ such that $c_1(S^* \otimes L_i)$ may be represented by a global form which vanishes on V_i .

Since $\{V_i\}$ covers $P(E)$, $\prod_{i=1}^n c_1(S^* \otimes L_i) = 0$. Writing $x = c_1(S^*)$, this gives by (20.1)

$$\prod_{i=1}^n (x + c_1(L_i)) = x^n + \sigma_1 x^{n-1} + \dots + \sigma_n = 0$$

where σ_i is the i th elementary symmetric polynomial of $c_1(L_1), \dots, c_1(L_n)$. But this equation is precisely the defining equation of $c(E)$. Thus

$$\sigma_i = c_i(E)$$

and

$$c(E) = \prod (1 + c_1(L_i)) = \prod c(L_i).$$

So the Whitney product formula holds for a direct sum of line bundles. By the splitting principle it holds for any complex vector bundle. As an illustration of the splitting principle we will go through the argument in detail. Let E and E' be two complex vector bundles of rank n and m respectively and let $\pi: F(E) \rightarrow M$ and $\pi': F(\pi^{-1}E') \rightarrow F(E)$ be the splitting constructions. Both bundles split completely when pulled back to $F(\pi^{-1}E')$ as indicated in the diagram below.

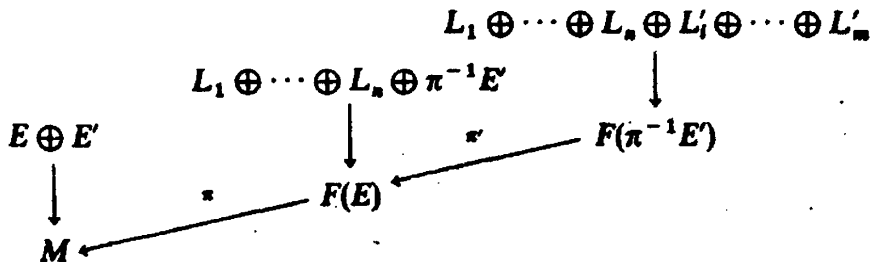

Let $\sigma = \pi' \circ \pi$. Then

$$\begin{aligned} \sigma^*c(E \oplus E') &= c(\sigma^{-1}(E \oplus E')) = c(L_1 \oplus \dots \oplus L_n \oplus L'_1 \oplus \dots \oplus L'_m) \\ &= \prod c(L_i)c(L'_i) \\ &= \sigma^*c(E)c^*(E') = \sigma^*c(E)c(E'). \end{aligned}$$

Since σ^* is injective, $c(E \oplus E') = c(E)c(E')$. This concludes the proof of the Whitney product formula.

REMARK 21.6. By Exercise (21.1) and the Whitney product formula, whenever we have an exact sequence of C^∞ complex vector bundles

$$0 \rightarrow A \rightarrow B \rightarrow C \rightarrow 0,$$

then $c(B) = c(A)c(C)$.

As an application of the existence of the split manifold and the Whitney product formula, we will prove now the relation (20.10.6) between the top Chern class and the Euler class. Let E be a rank n complex vector bundle and $\sigma: F(E) \rightarrow E$ its split manifold. Write $\sigma^{-1}E = L_1 \oplus \cdots \oplus L_n$, where the L_i 's are line bundles on the split manifold $F(E)$.

$$\begin{aligned}
 \sigma^* c_n(E) &= c_n(\sigma^{-1}E) && \text{by the naturality of } c_n \\
 &= c_1(L_1) \cdots c_1(L_n) && \text{by the Whitney product formula} \\
 & && \text{(20.10.3)} \\
 &= e((L_1)_\mathbb{R}) \cdots e((L_n)_\mathbb{R}) && \text{by the definition of the first Chern} \\
 & && \text{class of a complex line bundle} \\
 &= e((L_1)_\mathbb{R} \oplus \cdots \oplus (L_n)_\mathbb{R}) && \text{by the Whitney product formula for} \\
 & && \text{the Euler class (12.5)} \\
 &= e((\sigma^{-1}E)_\mathbb{R}) \\
 &= \sigma^* e(E_\mathbb{R}).
 \end{aligned}$$

By the injectivity of σ^* on cohomology, $c_n(E) = e(E_\mathbb{R})$.

Computation of Some Chern Classes

Given a rank n complex vector bundle E we may write formally

$$c(E) = \prod_{i=1}^n (1 + x_i),$$

where the x_i 's may be thought of as the first Chern class of the line bundles into which E splits when pulled back to the splitting manifold $F(E)$. Since the Chern classes $c_1(E), \dots, c_n(E)$ are the elementary symmetric functions of x_1, \dots, x_n , by the symmetric function theorem (van der Waerden [1, p. 99]) any symmetric polynomial in x_1, \dots, x_n is a polynomial in $c_1(E), \dots, c_n(E)$; a similar result holds for power series.

EXAMPLE 21.7 (Exterior powers, symmetric powers, and tensor products). Recall that if V is a vector space with basis $\{v_1, \dots, v_n\}$, then the exterior power $\Lambda^p V$ is the vector space with basis $\{v_{i_1} \wedge \cdots \wedge v_{i_p}\}_{1 \leq i_1 < \cdots < i_p \leq n}$. So if E is the direct sum of line bundles $E = L_1 \oplus \cdots \oplus L_n$, then

$$\Lambda^p E = \bigoplus_{1 \leq i_1 < \cdots < i_p \leq n} (L_{i_1} \otimes \cdots \otimes L_{i_p}).$$

Hence

$$\begin{aligned}
 c(\Lambda^p E) &= \prod (1 + c_1(L_{i_1} \otimes \cdots \otimes L_{i_p})) && \text{by the Whitney product formula} \\
 &= \prod (1 + x_{i_1} + \cdots + x_{i_p}) && \text{by (20.1), with } x_i = c_1(L_i),
 \end{aligned}$$

where the product is over all multi-indices $1 \leq i_1 < \cdots < i_p \leq n$. Since the right-hand side is symmetric in x_1, \dots, x_n , it is expressible as a polynomial

Q in $c_1(E), \dots, c_n(E)$, so

$$c(\Lambda^p E) = Q(c_1(E), \dots, c_n(E)).$$

By the splitting principle this formula holds for every rank n vector bundle, whether it is a direct sum or not. It should be pointed out that the polynomial Q depends only on n and p , not on E ; for example, the Chern class of $\Lambda^2 E$, where $\text{rank } E = 3$, is given by

$$\begin{aligned} c(\Lambda^2 E) &= Q(c_1, c_2, c_3) = (1 + c_1 - x_1)(1 + c_1 - x_2)(1 + c_1 - x_3) \\ &= (1 + c_1)^3 - c_1(1 + c_1)^2 + c_2(1 + c_1) - c_3. \end{aligned}$$

Similarly, if V and W are vector spaces with bases $\{v_1, \dots, v_n\}$ and $\{w_1, \dots, w_m\}$ respectively, then the p th symmetric power $S^p V$ of V is the vector space with basis $\{v_{i_1} \otimes \dots \otimes v_{i_p}\}_{1 \leq i_1 < \dots < i_p \leq n}$ and the tensor product $V \otimes W$ is the vector space with basis $\{v_i \otimes w_j\}_{1 \leq i \leq n, 1 \leq j \leq m}$. By the same discussion as above, if E is a rank n vector bundle with $c(E) = \prod_{i=1}^n (1 + x_i)$ and F is a rank m vector bundle with $c(F) = \prod_{j=1}^m (1 + y_j)$, then

$$(21.8) \quad c(S^p E) = \prod_{1 \leq i_1 < \dots < i_p \leq n} (1 + x_{i_1} + \dots + x_{i_p})$$

and

$$(21.9) \quad c(E \otimes F) = \prod_{\substack{1 \leq i \leq n \\ 1 \leq j \leq m}} (1 + x_i + y_j).$$

In particular if L is a complex line bundle with first Chern class y , then

$$(21.10) \quad c(E \otimes L) = \prod_{i=1}^n (1 + y + x_i) = \sum_{i=0}^n c_i(E)(1 + y)^{n-i},$$

where by convention we set $c_0(E) = 1$.

EXAMPLE 21.11 (The L -class and the Todd class). In the notation of the preceding example the power series

$$\prod_{i=1}^n \frac{\sqrt{x_i}}{\tanh \sqrt{x_i}}$$

is symmetric in x_1, \dots, x_n , hence is some power series L in $c_1(E), \dots, c_n(E)$. This power series $L(E) = L(c_1(E), \dots, c_n(E))$ is called the L -class of E . By the splitting principle the L -class automatically satisfies the product formula

$$L(E \oplus F) = L(E)L(F).$$

Similarly,

$$\prod_{i=1}^n \frac{x_i}{1 - e^{-x_i}} = \text{Td}(c_1(E), \dots, c_n(E)) = \text{Td}(E)$$

defines the *Todd class* of E . By the splitting principle the Todd class also automatically satisfies the product formula. The L -class and the Todd

class turn out to be of fundamental importance in the Hirzebruch signature formula (see Remark 22.9) and the Riemann–Roch theorem (see Hirzebruch [1]).

EXAMPLE 21.12 (The dual bundle). Let L be a complex line bundle. By (20.2),

$$c_1(L^*) = -c_1(L).$$

Next consider a direct sum of line bundles

$$E = L_1 \oplus \cdots \oplus L_n.$$

By the Whitney product formula

$$c(E) = c(L_1) \cdots c(L_n) = (1 + c_1(L_1)) \cdots (1 + c_1(L_n)).$$

On the other hand

$$E^* = L_1^* \oplus \cdots \oplus L_n^*$$

and

$$c(E^*) = (1 - c_1(L_1)) \cdots (1 - c_1(L_n)).$$

Therefore

$$c_q(E^*) = (-1)^q c_q(E).$$

By the splitting principle this result holds for all complex vector bundles E .

EXAMPLE 21.13 (The Chern classes of the complex projective space). By analogy with the definition of a differentiable manifold, we say that a second countable, Hausdorff space M is a *complex manifold* of dimension n if every point has a neighborhood U_α homeomorphic to some open ball in \mathbb{C}^n , $\phi_\alpha: U_\alpha \rightarrow \mathbb{C}^n$, such that the transition functions

$$g_{\alpha\beta} = \phi_\alpha \circ \phi_\beta^{-1}: \phi_\beta(U_\alpha \cap U_\beta) \rightarrow \mathbb{C}^n$$

are holomorphic. Smooth maps and smooth vector bundles have obvious analogues in the holomorphic category. If u_1, \dots, u_n are the coordinate functions on \mathbb{C}^n , then $z_i = u_i \circ \phi_\alpha$, $i = 1, \dots, n$, are the coordinate functions on U_α . At each point p in U_α the vectors $\partial/\partial z_1, \dots, \partial/\partial z_n$ span over \mathbb{C} the *holomorphic tangent bundle* of M . It is a complex vector bundle of rank n . The Chern class of a complex manifold is defined to be the Chern class of its holomorphic tangent bundle.

The complex projective space CP^n is an example of a complex manifold, since, as in Exercise 6.44, the transition functions g_{ji} relative to the standard open cover are given by multiplication by z_i/z_j , which are holomorphic functions from $\phi_i(U_i \cap U_j)$ to $\phi_j(U_i \cap U_j)$. Recall that there is a tautological exact sequence on CP^n

$$0 \rightarrow S \rightarrow C^{n+1} \rightarrow Q \rightarrow 0,$$

where C^{n+1} denotes the trivial bundle of rank $n + 1$ over CP^n . A tangent

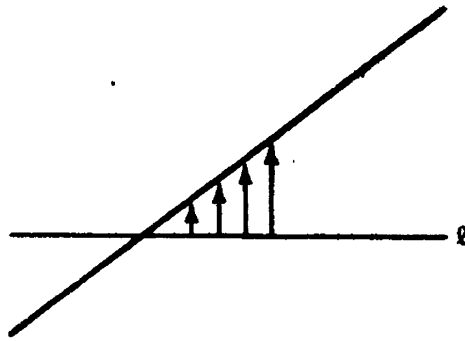

Figure 21.1

vector to CP^n at a line l in C^{n+1} may be regarded as an infinitesimal motion of the line l (Figure 21.1). Such a motion corresponds to a linear map from l to the quotient space C^{n+1}/l , which may be represented by the complementary subspace of l in C^{n+1} (relative to some metric). Thus, denoting the holomorphic tangent bundle by T , we have

$$T \simeq \text{Hom}(S, Q) = Q \otimes S^*$$

We will compute the Chern class of T in two ways.

(1) Tensoring the tautological sequence with S^* , we get

$$0 \rightarrow C \rightarrow S^* \otimes C^{n+1} \rightarrow S^* \otimes Q \rightarrow 0.$$

By the Whitney product formula

$$c(T) = c(S^* \otimes Q) = c(S^* \otimes C^{n+1}) = c(S^* \oplus \cdots \oplus S^*) = (1 + x)^{n+1},$$

where $x = c_1(S^*)$.

(2) From the tautological exact sequence and the Whitney product formula

$$c(Q) = \frac{1}{c(S)} = \frac{1}{1 - x} = 1 + x + \cdots + x^n,$$

since $x^{n+1} = 0$ in $H^*(CP^n)$. By (21.10)

$$\begin{aligned} c(CP^n) &= c(Q \otimes S^*) = \sum_{i=0}^n c_i(Q)(1+x)^{n-i} = \sum_{i=0}^n x^i (1+x)^{n-i} \\ &= (1+x)^n \sum_{i=0}^n \left(\frac{x}{1+x}\right)^i \\ &= (1+x)^n \left[\frac{1 - \left(\frac{x}{1+x}\right)^{n+1}}{1 - \frac{x}{1+x}} \right] \\ &= (1+x)^{n+1} \left[1 - \left(\frac{x}{1+x}\right)^{n+1} \right] \\ &= (1+x)^{n+1} - x^{n+1} \\ &= (1+x)^{n+1}. \end{aligned}$$

Exercise 21.14. Chern classes of a hypersurface in a complex projective space. Let H be the hyperplane bundle over the projective space CP^n (see (20.3)), and $H^{\otimes k}$ the tensor product of k copies of H . The line bundle H is in fact more than a C^∞ complex line bundle; because its transition functions are holomorphic, it is a *holomorphic* line bundle. The total space of a holomorphic bundle over a complex manifold is again a complex manifold, so that the notion of a *holomorphic section* makes sense. The zero locus of a holomorphic section of $H^{\otimes k}$ is called a *hypersurface of degree k* in CP^n . If the section is transversal to the zero section, then the hypersurface is a smooth complex manifold. Compute the Chern classes of a smooth hypersurface of degree k in CP^n . (*Hint*: apply Prop. 12.7 to get the normal bundle of the hypersurface.)

Flag Manifolds

Given a complex vector space V of dimension n , a *flag* in V is a sequence of subspaces $A_1 \subset A_2 \subset \cdots \subset A_n = V$, $\dim_{\mathbb{C}} A_i = i$. Let $Fl(V)$ be the collection of all flags in V . Clearly any flag can be carried into any other flag in V by an element of the general linear group $GL(n, \mathbb{C})$, and the stabilizer at a flag is the group H of the upper triangular matrices. So as a set $Fl(V)$ is isomorphic to the coset space $GL(n, \mathbb{C})/H$. Since the quotient of a Lie group by a closed subgroup is a manifold (Warner [1, p. 120]), $Fl(V)$ can be made into a manifold. It is called the *flag manifold* of V .

Given a vector bundle E , just as one can form its projectivization $P(E)$, so one can form its *associated flag bundle* $Fl(E)$. The bundle $Fl(E)$ is obtained from E by replacing each fiber E_p by the flag manifold $Fl(E_p)$; the local trivialization $\phi_\alpha: E|_{U_\alpha} \simeq U_\alpha \times \mathbb{C}^n$ induces a natural trivialization $Fl(E)|_{U_\alpha} \simeq U_\alpha \times Fl(\mathbb{C}^n)$. Since $GL(n, \mathbb{C})$ acts on $Fl(\mathbb{C}^n)$, we may take the transition functions of $Fl(E)$ to be those of E , but note that $Fl(E)$ is not a vector bundle.

Proposition 21.15. *The associated flag bundle $Fl(E)$ of a vector bundle is the split manifold $F(E)$ constructed earlier.*

PROOF. We first show this for $E = V$ a vector space of dimension 3, viewed as a rank 3 vector bundle over a point.

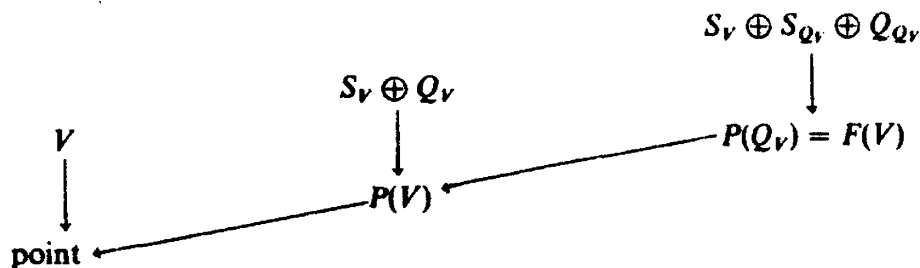

In what follows all lines and planes go through the origin. A point in $P(V)$ is a line L in V . A point of $P(Q_V)$ is a line L in V and a line L' in V/L . L' may be regarded as a 2-plane in V containing L . Thus $Fl(V) = P(Q_V) = \{A_1 \subset A_2 \subset V, \dim A_i = i\} = F(V)$.

Now let E be a vector bundle of rank n over M . The split manifold $F(E)$ is obtained by a sequence of $n - 1$ projectivizations as in (21.2). A point of $P(E)$ is a pair (p, ℓ) , where p is in M and ℓ is a line in E_p . By introducing a Hermitian metric on E , we may regard all the quotient bundles Q_1, \dots, Q_{n-1} in (21.2) as subbundles of E . Then a point of $P(Q_1)$ over (p, ℓ_1) in $P(E)$ is a triple (p, ℓ_1, ℓ_2) where ℓ_2 is a line in the orthogonal complement of ℓ_1 in E_p . A point of $P(Q_2)$ over (p, ℓ_1, ℓ_2) in $P(Q_1)$ is a 4-tuple $(p, \ell_1, \ell_2, \ell_3)$ where ℓ_3 is a line in the orthogonal complement of ℓ_1 and ℓ_2 in E_p . Thus, more generally, a point in the split manifold $F(E) = P(Q_{n-1})$ may be identified with the flag

$$(p, \ell_1 \subset \{\ell_1, \ell_2\} \subset \{\ell_1, \ell_2, \ell_3\} \subset \dots \subset E_p).$$

This proves the equality of the split manifold $F(E)$ and the flag bundle $Fl(E)$.

From now on the notations $F(E)$ and $Fl(E)$ will be used interchangeably.

The formula (21.3) gives one description of the vector space structure of the cohomology of a flag bundle. To compute its ring structure we first recall from (20.7) that if E is a rank n complex vector bundle over M , then the cohomology ring of its projectivization is

$$H^*(P(E)) = H^*(M)[x]/(x^n + c_1(E)x^{n-1} + \dots + c_n(E)), \text{ where } x = c_1(S^*).$$

NOTATION. If A is a polynomial ring, and $a, b, c, f \in A$, then (a, b, c) denotes the ideal generated by a, b , and c , while $(f = 0)$ the ideal generated by the homogeneous components of f .

There is an alternate description of the ring structure which is sometimes very useful. We write $H^*(M)[c(S), c(Q)]$ for $H^*(M)[c_1(S), c_1(Q), \dots, c_{n-1}(Q)]$, where S and Q are the universal subbundle and quotient bundle on $P(E)$.

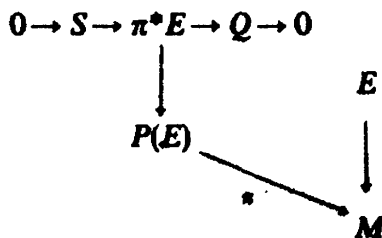

Proposition 21.16. $H^*(P(E)) = H^*(M)[c(S), c(Q)]/(c(S)c(Q) = \pi^*c(E))$.

PROOF. The idea is to eliminate the generators $c_1(Q), \dots, c_{n-1}(Q)$ by using the relation $c(S)c(Q) = \pi^*c(E)$. Let $x = c_1(S^*)$, $y_i = c_i(Q)$, and $c_i = \pi^*c_i(E)$. Equating the terms of equal degrees in

$$(1 - x)(1 + y_1 + \dots + y_{n-1}) = 1 + c_1 + \dots + c_n,$$

we get

$$\begin{aligned} y_1 - x &= c_1, \\ y_2 - xy_1 &= c_2, \\ y_3 - xy_2 &= c_3, \\ &\vdots \\ y_{n-1} - xy_{n-2} &= c_{n-1}, \\ -xy_{n-1} &= c_n. \end{aligned}$$

By the first $n - 1$ equations, y_1, \dots, y_{n-1} can be expressed in terms of x and elements of $H^*(M)$, and so can be eliminated as generators of $H^*(M)[c(S), c(Q)]/(c(S)c(Q) = \pi^*c(E))$. The last equation $-xy_{n-1} = c_n$ translates into

$$(*) \quad x^n + c_1x^{n-1} + \dots + c_n = 0.$$

Hence $H^*(M)[c(S), c(Q)]/(c(S)c(Q) = \pi^*c(E))$ is isomorphic to the polynomial ring over $H^*(M)$ with the single generator x and the single relation (*). \square

By (21.2) and (21.15) the flag bundle $Fl(E)$ is obtained from a sequence of $n - 1$ projectivizations. Applying Proposition 21.16 to (21.2), we have

$$\begin{aligned} H^*(P(Q_1)) &= H^*(P(E))[c(S_2), c(Q_2)]/(c(S_2)c(Q_2) = c(Q_1)) \\ &= H^*(M)[c(S_1), c(Q_1), c(S_2), c(Q_2)]/(c(S_1)c(Q_1) = c(E), c(S_2)c(Q_2) = c(Q_1)) \\ &= H^*(M)[c(S_1), c(S_2), c(Q_2)]/(c(S_1)c(S_2)c(Q_2) = c(E)). \end{aligned}$$

By induction

$$\begin{aligned} H^*(P(Q_{n-2})) &= H^*(M)[c(S_1), \dots, c(S_{n-1}), c(Q_{n-1})]/(c(S_1) \cdots c(S_{n-1})c(Q_{n-1}) = c(E)). \end{aligned}$$

Writing $x_i = c_1(S_i)$, $i = 1, \dots, n - 1$, and $x_n = c(Q_{n-1})$, the cohomology ring of the flag bundle $Fl(E)$ is

$$H^*(Fl(E)) = H^*(M)[x_1, \dots, x_n] / \left(\prod_{i=1}^n (1 + x_i) = c(E) \right).$$

Specializing this theorem to a complex vector space V , considered as the trivial bundle over a point, we obtain the cohomology ring of the flag manifold

$$H^*(Fl(V)) = \mathbf{R}[x_1, \dots, x_n] / \left(\prod_{i=1}^n (1 + x_i) = 1 \right).$$

As for the Poincaré polynomial of the flag manifold we note again that the flag manifold is obtained by a sequence of $n - 1$ projectivizations (21.2).

By (20.8) each time we projectivize a rank k vector bundle, the Poincaré polynomial is multiplied by $(1 - t^{2k})/(1 - t^2)$. So the Poincaré polynomial of the flag manifold $Fl(V)$ is

$$P_t(Fl(V)) = \frac{1 - t^{2n}}{1 - t^2} \cdot \frac{1 - t^{2n-2}}{1 - t^2} \cdots \frac{1 - t^2}{1 - t^2}.$$

This discussion may be summarized in the following proposition.

Proposition 21.17. *Let V be a complex vector space of dimension n . The cohomology ring of the flag manifold $Fl(V)$ is*

$$H^*(Fl(V)) = \mathbb{R}[x_1, \dots, x_n] / \left(\prod_{i=1}^n (1 + x_i) = 1 \right).$$

It has Poincaré polynomial

$$P_t(Fl(V)) = \frac{(1 - t^2)(1 - t^4) \cdots (1 - t^{2n})}{(1 - t^2)(1 - t^2) \cdots (1 - t^2)}.$$

REMARK 21.18. Similarly, if E is a rank n complex vector bundle over a manifold M , then the cohomology ring of the flag bundle $Fl(E)$ is

$$H^*(Fl(E)) = H^*(M)[x_1, \dots, x_n] / \left(\prod_{i=1}^n (1 + x_i) = c(E) \right),$$

and the Poincaré series is

$$P_t(Fl(E)) = P_t(M) \frac{(1 - t^2)(1 - t^4) \cdots (1 - t^{2n})}{(1 - t^2)(1 - t^2) \cdots (1 - t^2)}.$$

REMARK 21.19. Since projectivization does not introduce any torsion element in integer cohomology, the integer cohomology ring of the flag manifold $Fl(V)$ is torsion-free and is given by the same formula as (21.17) with \mathbb{Z} in place of \mathbb{R} . The integer cohomology ring of a flag bundle is given by the same formula as (21.18). In fact, with a little care, the entire discussion can be translated into the Čech theory.

§22 Pontrjagin Classes

Although the Chern classes are invariants of a complex bundle, they can be used to define invariants of a real vector bundle, called the *Pontrjagin classes*. In this section we define the Pontrjagin classes, compute a few examples, and as an application obtain an embedding criterion for differentiable manifolds.

Conjugate Bundles

Let V be a complex vector space. If $z \in \mathbb{C}$ and $v \in V$, the formula

$$z * v = \bar{z}v$$

defines an action of \mathbb{C} on V . The underlying additive group of V with this action as scalar multiplication is called the *conjugate vector space* of V , denoted \bar{V} . The conjugate space \bar{V} may be thought of as V with the opposite complex structure; as a vector space, \bar{V} is anti-isomorphic to V . A linear map $f: V \rightarrow W$ of two complex vector spaces V and W is also a linear map of the conjugate vector spaces $f: \bar{V} \rightarrow \bar{W}$; we denote both by f as they are represented by the same matrix.

Given a complex vector bundle E with trivialization

$$\phi_\alpha: E|_{U_\alpha} \simeq U_\alpha \times \mathbb{C}^n,$$

we construct the *conjugate vector bundle* \bar{E} by replacing each fiber of E by its conjugate. The trivialization of \bar{E} is given by

$$\bar{\phi}_\alpha: \bar{E}|_{U_\alpha} \simeq U_\alpha \times \mathbb{C}^n,$$

which is the composition

$$\bar{E}|_{U_\alpha} \xrightarrow{\bar{\phi}_\alpha} U_\alpha \times \bar{\mathbb{C}}^n \xrightarrow{\text{conjugation}} U_\alpha \times \mathbb{C}^n.$$

In terms of transition functions, if the cocycle $\{g_{\alpha\beta}\}$ defines E , then its conjugate $\{\bar{g}_{\alpha\beta}\}$ defines \bar{E} .

As in (6.4), by endowing a complex vector bundle on a manifold with a Hermitian metric, we can reduce its structure group to the unitary group. Since unitary matrices $g_{\alpha\beta}$ satisfy $\bar{g}_{\alpha\beta} = (g_{\alpha\beta}^t)^{-1}$, we see that the conjugate bundle \bar{E} and the dual bundle E^* have the same transition functions and hence are isomorphic. So by Example 21.12, if $c(E) = \prod (1 + x_i)$, then $c(\bar{E}) = \prod (1 - x_i)$.

Realization and Complexification

By simply forgetting the complex structure, we can regard a linear map of complex vector spaces $L: \mathbb{C}^n \rightarrow \mathbb{C}^n$ with coordinates z_1, \dots, z_n as a linear map of the underlying real vector spaces $L_{\mathbb{R}}: \mathbb{R}^{2n} \rightarrow \mathbb{R}^{2n}$ with coordinates x_1, \dots, x_{2n} where $z_k = x_{2k-1} + ix_{2k}$. Conversely, via the natural embedding of \mathbb{R}^n in \mathbb{C}^n , a linear map of real vector spaces $L: \mathbb{R}^n \rightarrow \mathbb{R}^n$ gives rise to a map $L \otimes \mathbb{C}: \mathbb{C}^n \rightarrow \mathbb{C}^n$. The first operation is called *realization* and the second, *complexification*. The complexification of a real matrix is the matrix itself, but with the entries viewed as complex numbers. The realization of a complex matrix is described in Examples 22.2 and 22.3 below. In terms of

matrices these two operations give a sequence of embeddings

$$(22.1) \quad \begin{array}{ccccc} U(n) & \hookrightarrow & O(2n) & \hookrightarrow & U(2n) \\ \cap & & \cap & & \cap \\ GL(n, \mathbb{C}) & \hookrightarrow & GL(2n, \mathbb{R}) & \hookrightarrow & GL(2n, \mathbb{C}) \\ A & \mapsto & A_{\mathbb{R}} & \mapsto & A_{\mathbb{R}} \otimes \mathbb{C}. \end{array}$$

EXAMPLE 22.2. Let $L: \mathbb{C} \rightarrow \mathbb{C}$ be given by multiplication by the complex number $\lambda = \alpha + i\beta$. Since

$$(\alpha + i\beta)(x_1 + ix_2) = (\alpha x_1 - \beta x_2) + i(\beta x_1 + \alpha x_2),$$

as a linear map from \mathbb{R}^2 to \mathbb{R}^2 , $L_{\mathbb{R}}$ is given by

$$\begin{pmatrix} x_1 \\ x_2 \end{pmatrix} \mapsto \begin{pmatrix} \alpha & -\beta \\ \beta & \alpha \end{pmatrix} \begin{pmatrix} x_1 \\ x_2 \end{pmatrix}.$$

Thus

$$(\alpha + i\beta)_{\mathbb{R}} = \begin{pmatrix} \alpha & -\beta \\ \beta & \alpha \end{pmatrix}.$$

EXAMPLE 22.3 Let $L: \mathbb{C}^2 \rightarrow \mathbb{C}^2$ be given by the complex matrix $\begin{pmatrix} \lambda_1 & \lambda_2 \\ \lambda_3 & \lambda_4 \end{pmatrix}$ where $\lambda_k = \alpha_k + i\beta_k$. A little computation shows that $L_{\mathbb{R}}: \mathbb{R}^4 \rightarrow \mathbb{R}^4$ is given by

$$\begin{pmatrix} x_1 \\ x_2 \\ x_3 \\ x_4 \end{pmatrix} \mapsto \begin{pmatrix} \alpha_1 & -\beta_1 & \alpha_2 & -\beta_2 \\ \beta_1 & \alpha_1 & \beta_2 & \alpha_2 \\ \alpha_3 & -\beta_3 & \alpha_4 & -\beta_4 \\ \beta_3 & \alpha_3 & \beta_4 & \alpha_4 \end{pmatrix} \begin{pmatrix} x_1 \\ x_2 \\ x_3 \\ x_4 \end{pmatrix}.$$

Thus

$$\begin{pmatrix} \lambda_1 & \lambda_2 \\ \lambda_3 & \lambda_4 \end{pmatrix}_{\mathbb{R}} = \begin{pmatrix} (\lambda_1)_{\mathbb{R}} & (\lambda_2)_{\mathbb{R}} \\ (\lambda_3)_{\mathbb{R}} & (\lambda_4)_{\mathbb{R}} \end{pmatrix}$$

It is clear from these two examples what the realization of an n by n complex matrix should be.

Lemma 22.4. *Let A be an n by n complex matrix. There is a $2n$ by $2n$ matrix B , independent of A , such that $A_{\mathbb{R}} \otimes \mathbb{C}$ is similar to $\begin{pmatrix} A & 0 \\ 0 & \bar{A} \end{pmatrix}$ via B .*

PROOF. In the 1 by 1 case, this is a matter of diagonalizing

$$(\alpha + i\beta)_{\mathbb{R}} \otimes \mathbb{C} = \begin{pmatrix} \alpha & -\beta \\ \beta & \alpha \end{pmatrix}.$$

This result may be seen alternatively as follows. On the complex vector space $E_{\mathbb{R}} \otimes \mathbb{C}$, multiplication by i is a linear transformation J satisfying $J^2 = -1$. Therefore, the eigenvalues of J are $\pm i$ and $E_{\mathbb{R}} \otimes \mathbb{C}$ accordingly decomposes into a direct sum

$$E_{\mathbb{R}} \otimes \mathbb{C} = (i\text{-eigenspace}) \oplus ((-i)\text{-eigenspace}).$$

On the i -eigenspace, J acts as multiplication by i , hence

$$(i\text{-eigenspace}) \supset E.$$

Similarly,

$$((-i)\text{-eigenspace}) \supset \bar{E}.$$

It follows by reasons of dimension that

$$E_{\mathbb{R}} \otimes \mathbb{C} = E \oplus \bar{E}.$$

The Pontrjagin Classes of a Real Vector Bundle

By their naturality property the Chern classes of a C^∞ complex vector bundle are C^∞ invariants of the bundle. For a real vector bundle E similar invariants may be obtained by considering the Chern classes of its complexification $E \otimes_{\mathbb{R}} \mathbb{C}$; these are the *Pontrjagin classes* of E . More precisely, if E is a rank n real vector bundle over M , then its *total Pontrjagin class* is

$$\begin{aligned} p(E) &= 1 + p_1(E) + \cdots + p_n(E) \\ &= 1 + c_1(E \otimes \mathbb{C}) + \cdots + c_n(E \otimes \mathbb{C}) \in H^*(M). \end{aligned}$$

It follows from the corresponding properties of the total Chern class that the Pontrjagin class is functorial and satisfies the Whitney product formula

$$p(E \oplus E') = p(E)p(E').$$

The Pontrjagin class of a manifold is defined to be that of its tangent bundle.

REMARK 22.6. Let E be a real vector bundle. Because the transition functions of $E \otimes \mathbb{C}$ are the same as those of E , they are real-valued, and therefore $E \otimes \mathbb{C}$ is isomorphic to its conjugate $\overline{E \otimes \mathbb{C}}$. It follows that $c_i(E \otimes \mathbb{C}) = c_i(\overline{E \otimes \mathbb{C}}) = (-1)^i c_i(E \otimes \mathbb{C})$. For an odd i , then, $2c_i(E \otimes \mathbb{C}) = 0$. Thus the odd Pontrjagin classes, as we have defined them, are zero in the de Rham cohomology, and torsion of order 2 in the integral cohomology. The usual definition of the Pontrjagin classes in the literature (see, for instance, Milnor and Stasheff [1, p. 174]) ignores these odd Chern classes and defines $p_i(E)$ to be

$$(-1)^i c_{2i}(E \otimes \mathbb{C}).$$

EXAMPLE 22.7. (The Pontrjagin class of the sphere). Since the sphere S^n is orientable, its normal bundle N in \mathbb{R}^{n+1} is trivial. From the exact sequence

$$0 \rightarrow T_{S^n} \rightarrow T_{\mathbb{R}^{n+1}}|_{S^n} \rightarrow N \rightarrow 0,$$

we see by the Whitney product formula that

$$p(S^n)p(N) = p(T_{\mathbb{R}^{n+1}}|_{S^n}).$$

Therefore,

$$p(S^n) = 1.$$

EXAMPLE 22.8 (The Pontrjagin class of a complex manifold). The Pontrjagin class of a complex manifold M is defined to be that of the underlying real manifold $M_{\mathbb{R}}$. Let T be the holomorphic tangent bundle to M . Then the tangent bundle to $M_{\mathbb{R}}$ is the realization of T and

$$p(M) = p(T_{\mathbb{R}}) = c(T_{\mathbb{R}} \otimes \mathbb{C}) = c(T \oplus \bar{T}) = c(T)c(\bar{T}).$$

So if the total Chern class of the complex manifold M is $c(M) = \prod (1 + x_i)$, then the Pontrjagin class is $p(M) = \prod (1 - x_i^2)$.

REMARK 22.8.1. If we had followed the usual sign convention for the Pontrjagin classes (see Remark 22.6), the Pontrjagin class of a complex manifold would be $p(M) = \prod (1 + x_i^2)$, where the x_i 's are defined as above. To have only positive terms in this formula is one of the reasons for the sign in $(-1)^i c_{2i}(E \otimes \mathbb{C})$ in the usual definition of the Pontrjagin class.

REMARK 22.9. Let M be a compact oriented manifold of dimension $4n$. By Poincaré duality the wedge product $\wedge : H^{2n}(M) \otimes H^{2n}(M) \rightarrow \mathbb{R}$ is a nondegenerate symmetric bilinear form and hence has a signature; this is called the *signature* of M . Recall that the signature of a symmetric matrix is the number of positive eigenvalues minus the number of negative eigenvalues. Hirzebruch proved that the signature is expressible in terms of the Pontrjagin classes.

Hirzebruch signature formula:

$$\text{signature of } M = \int_M L(p_1(M), \dots, p_{4n}(M)),$$

where L is the polynomial defined in Example 21.11. For a proof of the signature formula, see Milnor and Stasheff [1, p. 224].

Application to the Embedding of a Manifold in a Euclidean Space

Using the Pontrjagin class one can sometimes decide if a conjectured embedding is possible. We illustrate this with the following example.

EXAMPLE 22.10. *Decide if CP^4 can be differentiably embedded in R^9 .*

By (22.8) and (21.13) the Pontrjagin class of CP^4 is

$$p(CP^4) = c(T_{CP^4})c(\bar{T}_{CP^4}) = (1+x)^5(1-x)^5 = (1-x^2)^5.$$

If CP^4 can be differentiably embedded in R^9 , then there is an exact sequence

$$0 \rightarrow (T_{CP^4})_{\mathbb{R}} \rightarrow T_{\mathbb{R}^9}|_{CP^4} \rightarrow N \rightarrow 0,$$

where $(T_{CP^4})_{\mathbb{R}}$ is the realization of the holomorphic tangent bundle T_{CP^4} and N is the normal bundle of CP^4 in R^9 . By the Whitney product formula

$$(22.11) \quad p(T_{\mathbb{R}^9}|_{CP^4}) = p((T_{CP^4})_{\mathbb{R}})p(N).$$

Since the restriction $T_{\mathbb{R}^9}|_{CP^4}$ is the pullback of $T_{\mathbb{R}^9}$ to CP^4 under the embedding $i: CP^4 \rightarrow R^9$, by the functoriality of the Pontrjagin class

$$p(T_{\mathbb{R}^9}|_{CP^4}) = i^*p(T_{\mathbb{R}^9}) = 1.$$

Therefore, by (22.11)

$$(22.12) \quad p(N) = \frac{1}{p((T_{CP^4})_{\mathbb{R}})} = \frac{1}{(1-x^2)^5} = 1 + 5x^2 + 15x^4.$$

Since N is a real line bundle, the top component of $p(N)$ should be in $H^2(CP^4)$. This contradicts the fact that $5x^2$ and $15x^4$ are nonzero classes in $H^4(CP^4)$ and $H^8(CP^4)$. Thus CP^4 cannot be embedded in R^9 .

From (22.12), if CP^4 can be embedded in R^n , then the normal bundle has rank at least 4, since the top-degree term of the Pontrjagin class of a rank k real bundle is in dimension $2k$. It follows that CP^4 cannot be embedded in a Euclidean space of dimension 11 or less.

§23 The Search for the Universal Bundle

Let $f: M \rightarrow N$ be a complex map between two manifolds and E a complex bundle over N . The pullback $f^{-1}E$ is a bundle over M . If the Chern classes of E vanish, by the naturality property (20.10.1), so do those of $f^{-1}E$. Taking the Chern classes to be a measure of the twisting of a bundle, we may assert that pulling back "dilutes" a bundle, i.e., makes it less twisted. One extreme example is when f is constant; in this case $f^{-1}E$ is trivial. Another example is the flag construction of Section 21; pulling E back to the split manifold $F(E)$ splits E into a direct sum of line bundles. One may wonder if there exists a bundle which is so twisted that every bundle is a pullback of this universal bundle. Such a bundle indeed exists, at least for manifolds of finite type; it is the universal quotient bundle on the Grassmannian $G_n(C^n)$ for n sufficiently large. We will prove this result and conclude from it that every natural transformation from the complex vector

bundles to the cohomology classes is expressible in terms of the Chern classes, all for manifolds of finite type. We also indicate how the theorems generalize to an arbitrary manifold.

The Grassmannian

Let V be a complex vector space of dimension n . The *complex Grassmannian* $G_k(V)$ is the set of all subspaces of complex codimension k in V . We sometimes call such a subspace an $(n - k)$ -plane in V . Given a Hermitian metric on V , the unitary group $U(n)$ is the group of all metric-preserving endomorphisms of V . Clearly $U(n)$ acts transitively on the collection of all $(n - k)$ -planes in V . Since a unitary matrix which sends an $(n - k)$ -plane to itself must also fix the complementary orthogonal k -plane, the stabilizer of an $(n - k)$ -plane in V is $U(n - k) \times U(k)$. Thus the Grassmannian can be represented as a homogeneous space

$$G_k(V) = \frac{U(n)}{U(k) \times U(n - k)}.$$

As the coset space of a Lie group by a closed subgroup, $G_k(V)$ is a differentiable manifold (Warner [1, p. 120]). Note that $G_{n-1}(V)$ is the projective space $P(V)$.

Just as in the case of the projective space, over the Grassmannian $G_k(V)$ there are three tautological bundles: the *universal subbundle* S , whose fiber at each point Λ of $G_k(V)$ is the $(n - k)$ -plane Λ itself; the *product bundle* $\hat{V} = G_k(V) \times V$; and the *universal quotient bundle* Q defined by

$$0 \rightarrow S \rightarrow \hat{V} \rightarrow Q \rightarrow 0.$$

This exact sequence is called the *tautological sequence* on $G_k(V)$. Over $G_k(V)$ the universal subbundle S has rank $n - k$ and the universal quotient bundle has rank k .

Similarly, if V is a real vector space, one can define the *real Grassmannian* $G_k(V)$ of codimension k real subspaces of V , and the analogous real universal bundles. The real Grassmannian can also be represented as a homogeneous space

$$G_k(\mathbb{R}^n) = \frac{O(n)}{O(k) \times O(n - k)}.$$

Proposition 23.1. *The cohomology of the complex Grassmannian $G_k(V)$ has Poincaré polynomial*

$$P_k(G_k(V)) = \frac{(1 - t^2) \cdots (1 - t^{2n})}{(1 - t^2) \cdots (1 - t^{2k})(1 - t^2) \cdots (1 - t^{2(n-k)})}.$$

PROOF. The flag manifold $F(V)$ may be obtained from the Grassmannian $G_k(V)$ by a series of flag constructions as follows. Let \hat{Q} be the pullback of Q to the flag bundle $F(S)$.

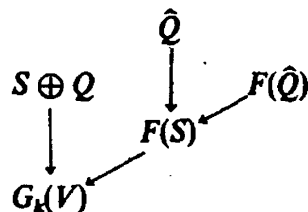

A point of $F(S)$ is a pair $(\Lambda, L_1 \subset \dots \subset \Lambda)$ consisting of an $(n - k)$ -plane Λ in V together with a flag in Λ . Therefore a point in $F(\hat{Q})$ consists of a point in $F(S)$, $(\Lambda, L_1 \subset \dots \subset \Lambda)$, together with a flag in V/Λ , i.e., a point in $F(\hat{Q})$ is given by $(\Lambda, L_1 \subset \dots \subset L_{n-k-1} \subset \Lambda \subset L_{n-k+1} \subset \dots \subset V)$. So $F(\hat{Q})$ is the flag manifold $F(V)$, and $F(V)$ is obtained from the Grassmannian $G_k(V)$ by two flag constructions. By (21.18), the Poincaré polynomials of $F(V)$ and $G_k(V)$ satisfy the relation

$$P_t(F(V)) = P_t(G_k(V)) \frac{(1 - t^2) \cdots (1 - t^{2(n-k)})(1 - t^2) \cdots (1 - t^{2k})}{(1 - t^2) \cdots (1 - t^2)(1 - t^2) \cdots (1 - t^2)}$$

From (21.17) it follows that

$$P_t(G_k(V)) = \frac{(1 - t^2) \cdots (1 - t^{2n})}{(1 - t^2) \cdots (1 - t^{2(n-k)})(1 - t^2) \cdots (1 - t^{2k})} \quad \square$$

As for the ring structure of the cohomology of the Grassmannian $G_k(V)$, we have the following.

Proposition 23.2. *Let V be a complex vector space of dimension n .*

(a) *As a ring*

$$H^*(G_k(V)) = \frac{\mathbb{R}[c_1(S), \dots, c_{n-k}(S), c_1(Q), \dots, c_k(Q)]}{(c(S)c(Q) = 1)}$$

(b) *The Chern classes $c_1(Q), \dots, c_k(Q)$ of the quotient bundle generate the cohomology ring $H^*(G_k(V))$.*

(c) *For a fixed k and a fixed i there are no polynomial relations of degree i among $c_1(Q), \dots, c_k(Q)$ if the dimension of V is large enough.*

PROOF. In the proof of Proposition 23.1, we saw that the flag manifold $F(V)$ is obtained from the Grassmannian by two flag constructions

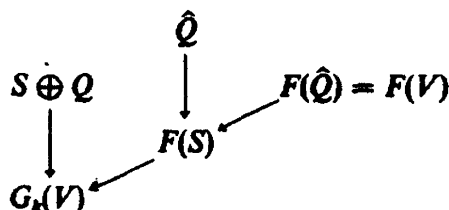

By (21.18) the cohomology ring of the flag manifold is

$$H^*(F(V)) = \frac{H^*(G_k(V))[x_1, \dots, x_{n-k}, y_1, \dots, y_k]}{(\prod (1+x_i) = c(S), \prod (1+y_j) = c(Q))}.$$

On the other hand, we've computed the cohomology of $F(V)$ in (21.17) to be

$$(*) \quad H^*(F(V)) = \mathbb{R}[x_1, \dots, x_{n-k}, y_1, \dots, y_k] / (\prod (1+x_i) \prod (1+y_j) = 1).$$

Thus in $H^*(G_k(V))$ the Chern classes of S and Q can satisfy no relation other than $c(S)c(Q) = 1$, for any relation among them would appear as a relation among the x_i 's and y_j 's in (*). It follows that there is an injection of algebras

$$(23.2.1) \quad \frac{\mathbb{R}[c(S), c(Q)]}{(c(S)c(Q) = 1)} \hookrightarrow H^*(G_k(V)).$$

From the digression following this proof, the Poincaré series of $\mathbb{R}[c_1(S), \dots, c_{n-k}(S), c_1(Q), \dots, c_k(Q)] / (c(S)c(Q) = 1)$ is

$$P_t \left(\frac{\mathbb{R}[c(S), c(Q)]}{(c(S)c(Q) = 1)} \right) = \frac{(1-t^2) \cdots (1-t^{2n})}{(1-t^2) \cdots (1-t^{2(n-k)})(1-t^2) \cdots (1-t^{2k})}.$$

But this is also the Poincaré series of $H^*(G_k(V))$. Thus the injection (23.2.1) is an isomorphism. This proves (a).

Writing $c(S) = 1/c(Q)$, we see from the description of the ring structure in (a) that $c_1(Q), \dots, c_k(Q)$ generate the cohomology ring of $G_k(V)$.

The equation $c(S) = 1/c(Q)$ not only allows one to eliminate $c_1(S), \dots, c_{n-k}(S)$ in terms of $c_1(Q), \dots, c_k(Q)$, but also gives polynomial relations of degrees $2(n-k+1), \dots, 2n$ among $c_1(Q), \dots, c_k(Q)$. Thus for a given degree i , if the dimension n of the vector space V is so large that $2(n-k+1) > i$, then there are no polynomial relations of degree i among the Chern classes of Q . \square

Digression on the Poincaré Series of a Graded Algebra

Let k be a field and $A = \bigoplus_{i=0}^{\infty} A_i$ a graded algebra over k . The *Poincaré series* of A is defined to be

$$P_t(A) = \sum_{i=0}^{\infty} (\dim_k A_i) t^i.$$

If A is a graded \mathbb{Z} -module, its Poincaré series is defined to be that of the \mathbb{Q} -algebra $A \otimes_{\mathbb{Z}} \mathbb{Q}$.

EXAMPLE. Let A be the polynomial ring $\mathbb{R}[x]$, where x is an element of degree n . Then

$$P_t(A) = 1 + t^n + t^{2n} + \cdots = \frac{1}{1-t^n}.$$

EXAMPLE. Let A and B be two graded algebras. Suppose a basis for A as a vector space is $\{x_i\}_{i \in I}$ and a basis for B is $\{y_j\}_{j \in J}$. Then a vector space basis for $A \otimes B$ is $\{x_i \otimes y_j\}_{i \in I, j \in J}$. Therefore

$$P_t(A \otimes B) = P_t(A)P_t(B).$$

EXAMPLE. Let $A = \mathbb{R}[x, y]$, with $\deg x = m$ and $\deg y = n$. Then since $\mathbb{R}[x, y] = \mathbb{R}[x] \otimes \mathbb{R}[y]$,

$$P_t(A) = P_t(\mathbb{R}[x])P_t(\mathbb{R}[y]) = \frac{1}{1-t^m} \cdot \frac{1}{1-t^n}.$$

We next investigate the effect of a relation on the Poincaré series of a graded algebra.

Proposition 23.3. *Let $A = \bigoplus_{i=0}^{\infty} A_i$ be a graded algebra over a field k , and x a homogeneous element of degree n in A . If x is not a zero-divisor, then*

$$P_t(A/xA) = P_t(A)(1-t^n).$$

PROOF. Because x is not a zero-divisor, multiplication by x is an injection. Hence for each integer i there is an exact sequence of vector spaces

$$0 \rightarrow A_i \xrightarrow{x} A_{i+n} \rightarrow (A/xA)_{i+n} \rightarrow 0.$$

By the additivity of the dimension,

$$\dim A_{i+n} = \dim A_i + \dim(A/xA)_{i+n}.$$

Summing over all i ,

$$\sum_{i=-n}^{\infty} (\dim A_{i+n})t^{i+n} = \sum_{i=-n}^{\infty} (\dim A_i)t^{i+n} + \sum_{i=-n}^{\infty} \dim(A/xA)_{i+n}t^{i+n},$$

where we set $A_i = \{0\}$ if i is negative. Hence

$$P_t(A) = P_t(A)t^n + P_t(A/xA). \quad \square$$

EXAMPLE. If x, y , and z are elements of degree 1, then the Poincaré series of $A = \mathbb{R}[x, y, z]/(x^3y + y^2z^2 + xy^2z)$ is

$$\begin{aligned} P_t(A) &= P_t(\mathbb{R}[x, y, z])(1-t^4) \\ &= (1-t^4)/(1-t^3). \end{aligned}$$

To generalize Proposition 23.3, we will need the notion of a *regular sequence*.

Definition. Let A be a ring. A sequence of elements a_1, \dots, a_r in A is a *regular sequence* if a_1 is not a zero-divisor in A and for each $i \geq 2$, the image of a_i in $A/(a_1, \dots, a_{i-1})$ is not a zero-divisor.

Proposition 23.4. *Let A be a graded algebra over a field k and a_1, \dots, a_r a regular sequence of homogeneous elements of degrees n_1, \dots, n_r . Then*

$$P_t(A/(a_1, \dots, a_r)) = P_t(A)(1 - t^{n_1}) \cdots (1 - t^{n_r}).$$

PROOF. This is an immediate consequence of Proposition 23.3 and induction on r . \square

Let I be the ideal in $\mathbb{R}[x_1, \dots, x_j, y_1, \dots, y_k]$ generated by the homogeneous terms of $(1 + x_1 + \cdots + x_j)(1 + y_1 + \cdots + y_k) - 1$. We will now compute the Poincaré series of $\mathbb{R}[x_1, \dots, x_j, y_1, \dots, y_k]/I$.

Lemma 23.5. *Let A be a graded algebra over a field k . If a_1, \dots, a_r is a regular sequence of homogeneous elements of positive degrees in A , so is any permutation of a_1, \dots, a_r .*

PROOF. Since any permutation is a product of transpositions of adjacent elements, it suffices to show that $a_1, \dots, a_{i-1}, a_{i+1}, a_i, \dots, a_r$ is a regular sequence. For this it is enough to show that in the ring $A/(a_1, \dots, a_{i-1})$, the images of a_{i+1}, a_i form a regular sequence. In this way the lemma is reduced to the case of two elements: if a, b is a regular sequence of elements of positive degrees in the graded algebra A , so is b, a .

If x is an element of A , we write \bar{x} for the image of x in whatever quotient ring of A being discussed. Assume that a, b is a regular sequence in A .

- (1) Suppose $bx = 0$ in A . Then $\bar{b}\bar{x} = 0$ in $A/(a)$. Since \bar{b} is not a zero-divisor in $A/(a)$, $x = ax_1$ for some x_1 in A . Therefore, $abx_1 = 0$ in A . Since a is not a zero divisor, $bx_1 = 0$. Repeating the argument, we get $x_1 = ax_2$, $x_2 = ax_3$, and so on. Thus $x = ax_1 = a^2x_2 = a^3x_3 = \dots$, showing that x is divisible by all the powers of a . Since a has positive degree, this is possible only if $x = 0$. Therefore b is not a zero-divisor in A .
- (2) Next we show that \bar{a} is not a zero-divisor in $A/(b)$. Suppose $\bar{a}\bar{x} = 0$ in $A/(b)$. Then $ax = by$ for some y in A . It follows that $\bar{b}\bar{y} = 0$ in $A/(a)$. Since \bar{b} is not a zero-divisor in $A/(a)$, $y = az$ for some z . Therefore, $ax = abz$. Since a is not a zero-divisor in A , $x = bz$; hence, $\bar{x} = 0$ in $A/(b)$. \square

Lemma 23.6. *If a_1, \dots, a_r, b and a_1, \dots, a_r, c are regular sequences in a ring A , then so is a_1, \dots, a_r, bc .*

PROOF. It suffices to check that bc is not a zero-divisor in $A/(a_1, \dots, a_r)$. This is clear since by hypothesis neither b nor c is a zero-divisor in $A/(a_1, \dots, a_r)$. \square

Proposition 23.7. *The homogeneous terms of*

$$(1 + x_1 + \cdots + x_j)(1 + y_1 + \cdots + y_k) - 1$$

form a regular sequence in $A = \mathbb{R}[x_1, \dots, x_j, y_1, \dots, y_k]$.

PROOF. The proof proceeds by induction on j and k . Suppose $j = 1$ and $k = 1$. Then $\mathbb{R}[x_1, y_1]/(x_1 + y_1) = \mathbb{R}[x_1]$ and the image of $x_1 y_1$ in $\mathbb{R}[x_1, y_1]/(x_1 + y_1)$ is $-x_1^2$, which is not a zero divisor. So $x_1 + y_1, x_1 y_1$ is a regular sequence in $\mathbb{R}[x_1, y_1]$. For a general j and k , let f_i be the homogeneous term of degree i in $(1 + x_1 + \cdots + x_j)(1 + y_1 + \cdots + y_k) - 1$. We first show that $f_1, \dots, f_{j+k-1}, x_j$ and $f_1, \dots, f_{j+k-1}, y_k$ are regular sequences. By Lemma 23.5, $f_1, \dots, f_{j+k-1}, x_j$ is a regular sequence if and only if $x_j, f_1, \dots, f_{j+k-1}$ is. Let \tilde{f}_i be the image of f_i in $A/(x_j)$. Since x_j is not a zero-divisor in A , it suffices to show that $\tilde{f}_1, \dots, \tilde{f}_{j+k-1}$ is a regular sequence in $A/(x_j)$. This is true by the induction hypothesis, since

$$A/(x_j) = \mathbb{R}[x_1, \dots, x_{j-1}, y_1, \dots, y_k]$$

and

$$1 + \tilde{f}_1 + \cdots + \tilde{f}_{j+k-1} = (1 + x_1 + \cdots + x_{j-1})(1 + y_1 + \cdots + y_k).$$

Therefore, $f_1, \dots, f_{j+k-1}, x_j$ is a regular sequence in A . Similarly, $f_1, \dots, f_{j+k-1}, y_k$ is also a regular sequence in A . By Lemma 23.6, so is $f_1, \dots, f_{j+k-1}, x_j y_k$. \square

By Propositions 23.4 and 23.7, if I is the ideal in

$$A = \mathbb{R}[x_1, \dots, x_{n-k}, y_1, \dots, y_k]$$

generated by the homogeneous terms of

$$(1 + x_1 + \cdots + x_{n-k})(1 + y_1 + \cdots + y_k) - 1,$$

where $\deg x_i = 2i$ and $\deg y_i = 2i$, then the Poincaré series of A/I is

$$P_t(A/I) = \frac{(1 - t^2) \cdots (1 - t^{2n})}{(1 - t^2) \cdots (1 - t^{2(n-k)})(1 - t^2) \cdots (1 - t^{2k})}$$

The Classification of Vector Bundles

We now show that the vector bundles over a manifold M may be classified up to isomorphism by the homotopy classes of maps from M into a Grassmannian. We will first discuss this in the complex case and then extend it by analogy to the real case.

Lemma 23.8. *Let E be a rank k complex vector bundle over a differentiable manifold M of finite type. There exist on M finitely many smooth sections of E which span the fiber at every point.*

PROOF. Let $\{U_i\}_{i \in I}$ be a finite good cover for M . Since U_i is contractible, $E|_{U_i}$ is trivial and so we can find k sections $s_{i,1}, \dots, s_{i,k}$ over U_i which form a basis of the fiber above any point in U_i . By the Shrinking Lemma (see (21.4) and (21.5)), there is an open cover $\{V_i\}_{i \in I}$ with $\bar{V}_i \subset U_i$ and smooth functions f_i such that f_i is identically 1 on V_i and identically 0 outside U_i . Then $\{f_i s_{i,1}, \dots, f_i s_{i,k}\}_{i \in I}$ are global sections of E which span the fiber at every point. \square

Proposition 23.9. *Let E be a rank k complex vector bundle over a differentiable manifold M of finite type. Suppose there are n global sections of E which span the fiber at every point. Then there is a map f from M to some Grassmannian $G_k(\mathbb{C}^n)$ such that E is the pullback under f of the universal quotient bundle Q ; that is, $E = f^{-1}Q$.*

PROOF. Let s_1, \dots, s_n be n spanning sections of E and let V be the complex vector space with basis s_1, \dots, s_n . Since s_1, \dots, s_n are spanning sections, for each point p in M the evaluation map

$$ev_p: V \rightarrow E_p \rightarrow 0$$

is surjective. Hence $\ker ev_p$ is a codimension k subspace of V , and the fiber of the universal quotient bundle Q at the point $\ker ev_p$ of the Grassmannian $G_k(V)$ is $V/\ker ev_p = E_p$. If the map $f: M \rightarrow G_k(V)$ is defined by

$$f: p \mapsto \ker ev_p,$$

then the quotient bundle Q pulls back to E . We can identify V with \mathbb{C}^n , and $G_k(V)$ with $G_k(\mathbb{C}^n)$. \square

This map $f: M \rightarrow G_k(\mathbb{C}^n)$ is called a *classifying map* for the bundle E .

In the proposition above, if $\{s'_1, \dots, s'_n\}$ is another choice of global sections which span the fiber at every point, and V' the vector space with basis s'_1, \dots, s'_n , then there is a natural isomorphism of V with V' , and of $G_k(V)$ with $G_k(V')$. Therefore the classifying map $f: M \rightarrow G_k(\mathbb{C}^n)$ is well-defined up to the identification of V with \mathbb{C}^n , independent of the choice of the n spanning sections. More precisely, any two such maps f and f' from M to $G_k(\mathbb{C}^n)$ differ by the action of an element B of $GL(n, \mathbb{C})$ on $G_k(\mathbb{C}^n)$; that is,

$$f' = B \circ f, \quad \text{where } B: G_k(\mathbb{C}^n) \rightarrow G_k(\mathbb{C}^n).$$

Since $GL(n, \mathbb{C})$ is connected, there is a path $\gamma(t)$ joining the identity element I and B in $GL(n, \mathbb{C})$. Then $f_t = \gamma(t) \circ f$ is a homotopy between f and f' . Therefore we may refine Proposition 23.9 to include the following statement.

(23.9.1) *The homotopy class of the classifying map $f : M \rightarrow G_k(\mathbb{C}^n)$ of the vector bundle E is uniquely determined by E .*

In fact, if $g : E \rightarrow E'$ is an isomorphism of vector bundles over M , then g gives a one-to-one correspondence between the sections of E and the sections of E' . So by the same reasoning as in (23.9.1), we see that E and E' determine homotopic classifying maps f and f' from M to the Grassmannian $G_k(\mathbb{C}^n)$. Writing $\text{Vect}_k(M; \mathbb{C})$ for the isomorphism classes of the rank k complex vector bundles over M and $[X, Y]$ for the set of all homotopy classes of maps from X to Y , we have the following.

(23.9.2) *For n sufficiently large, there is a well-defined map*

$$\beta : \text{Vect}_k(M; \mathbb{C}) \rightarrow [M, G_k(\mathbb{C}^n)]$$

given by the classifying map of a vector bundle.

REMARK 23.9.3. From the proof of Lemma 23.8, if M has a good cover with r open sets, then every rank k bundle over M has a set of rk spanning sections. Thus in (23.9) given the manifold M of finite type and the integer k , if n is an integer $\geq rk$, then the Grassmannian $G_k(\mathbb{C}^n)$ classifies all vector bundles of rank k over M .

Theorem 23.10. *Let M be a manifold having a good cover consisting of r open sets and let k be a positive integer. For every integer $n \geq kr$, there is a one-to-one correspondence*

$$\text{Vect}_k(M; \mathbb{C}) \simeq [M, G_k(\mathbb{C}^n)]$$

between the isomorphism classes of rank k complex vector bundles over M and the homotopy classes of maps from M into the complex Grassmannian $G_k(\mathbb{C}^n)$.

PROOF. By the homotopy property of vector bundles (Theorem 6.8), there is a map

$$\alpha : [M, G_k(\mathbb{C}^n)] \rightarrow \text{Vect}_k(M; \mathbb{C})$$

given by the pullback of the universal quotient bundle over $G_k(\mathbb{C}^n)$:

$$f \mapsto f^{-1}\mathcal{Q}.$$

By (23.9), (23.9.2), and (23.9.3), for any integer $n \geq rk$, the map

$$\beta : \text{Vect}_k(M; \mathbb{C}) \rightarrow [M, G_k(\mathbb{C}^n)],$$

given by the homotopy class of the classifying map of a vector bundle, is inverse to α . \square

As a corollary of the existence of the universal bundle (23.9), we now show that in a precise sense the Chern classes are the only cohomological invariants of a smooth complex vector bundle.

Proposition 23.11. *Every natural transformation from the isomorphism classes of complex vector bundles over a manifold of finite type to the de Rham cohomology can be given as a polynomial in the Chern classes.*

PROOF. Let T be a natural transformation from the functor $\text{Vect}_k(\cdot; \mathbb{C})$ to the functor $H^*(\cdot)$ in the category of manifolds of finite type. By Proposition 23.9 and the naturality of T , if E is any rank k complex vector bundle over M and $f : M \rightarrow G_k(\mathbb{C}^n)$ a classifying map for E , then

$$T(E) = T(f^{-1}Q) = f^*T(Q).$$

Because the cohomology of the Grassmannian $G_k(\mathbb{C}^n)$ is generated by the Chern classes of Q (Prop. 23.2(b)), $T(Q)$ can be written as

$$T(Q) = P_T(c_1(Q), \dots, c_k(Q))$$

for some polynomial P_T depending on T . Therefore

$$T(E) = f^*T(Q) = P_T(f^*c_1(Q), \dots, f^*c_k(Q)) = P_T(c_1(E), \dots, c_k(E)). \quad \square$$

Of course there is an analogue of Theorem 23.10 for real vector bundles. Recall that we write $\text{Vect}_k(M)$ for the isomorphism classes of the rank k real vector bundles over M .

Theorem 23.12. *Let M be a manifold having a good cover consisting of r open sets and k a positive integer. For every integer $n \geq rk$, there is a one-to-one correspondence*

$$\text{Vect}_k(M) \simeq [M, G_k(\mathbb{R}^n)].$$

The proof is completely analogous to that of Theorem 23.10.

We now classify the vector bundles over spheres and relate them to the homotopy groups of the orthogonal and unitary groups.

Exercise 23.13. (a) Use Exercise 17.24 and the homotopy exact sequence of the fibration

$$\begin{array}{ccc} O(k) & \rightarrow & O(n)/O(n-k) \\ & & \downarrow \\ & & G_k(\mathbb{R}^n) \end{array}$$

to show that

$$\pi_q(G_k(\mathbb{R}^n)) = \pi_{q-1}(O(k)) \quad \text{if } n \geq k + q + 2.$$

(b) Similarly show that

$$\pi_q(G_k(\mathbb{C}^n)) = \pi_{q-1}(U(k)) \quad \text{if } n \geq (2k + q + 1)/2.$$

Combining these formulas with Proposition 17.6.1 concerning the relation of free versus base-point preserving homotopies we find that for n

sufficiently large,

$$\begin{aligned}\text{Vect}_k(S^q) &= [S^q, G_k(\mathbb{R}^n)] \\ &= \pi_q(G_k(\mathbb{R}^n))/\pi_1(G_k(\mathbb{R}^n)) \\ &= \pi_{q-1}(O(k))/\pi_0(O(k)).\end{aligned}$$

Exactly the same computation works for the complex vector bundles over S^q . We summarize the results in the following.

Proposition 23.14. *The isomorphism classes of the differentiable rank k real vector bundles over the sphere S^q are given by*

$$\text{Vect}_k(S^q) \simeq \pi_{q-1}(O(k))/\mathbb{Z}_2;$$

the isomorphism classes of the complex vector bundles are given by

$$\text{Vect}_k(S^q; \mathbb{C}) \simeq \pi_{q-1}(U(k)).$$

REMARK 23.14.1 If G is a Lie group and $a \in G$, then conjugation by a defines an automorphism h_a of G :

$$h_a(g) = aga^{-1}$$

Let m be any integer. The map h_a induces a map of homotopy groups:

$$(h_a)_* : \pi_m(G) \rightarrow \pi_m(G).$$

If two elements a and b in G can be joined by a path $\gamma(t)$ in G , then h_a is homotopic to h_b via the homotopy $h_{\gamma(t)}$. Consequently $(h_a)_* = (h_b)_*$. In this way conjugation induces an action of $\pi_0(G)$ on $\pi_m(G)$, called the *adjoint action*.

We know from (17.6) that for any space X with base point x , conjugation on the loop space $\Omega_x X$ induces an action of $\pi_1(X)$ on $\pi_q(X)$. With a little more classifying space theory, it can be shown that the action of $\pi_0(O(k))$ on $\pi_{q-1}(O(k))$ corresponding to the action of $\pi_1(G_k(\mathbb{R}^n))$ on $\pi_q(G_k(\mathbb{R}^n))$ under the identification of $\pi_{q-1}(O(k))$ with $\pi_q(G_k(\mathbb{R}^n))$ is precisely the adjoint action.

REMARK 23.14.2. It is in fact possible to explain the correspondence (23.14) directly. Let E be a rank k vector bundle over S^q with structure group $O(k)$, and let U_0 and U_1 be small open neighborhoods of the upper and lower hemispheres. Because U_0 and U_1 are contractible, E is trivial over them. Hence E is completely determined by the transition function

$$g_{01} : U_0 \cap U_1 \rightarrow O(k).$$

g_{01} is called a *clutching function* for E . Then Proposition 23.14 may be interpreted as a correspondence between the isomorphism classes of vector bundles over a sphere and the free homotopy classes of the clutching functions.

Exercise 23.15. Compute $\text{Vect}_k(S^1)$, $\text{Vect}_k(S^2)$, and $\text{Vect}_k(S^3)$.

EXAMPLE 23.16 (An orientable sphere bundle with zero Euler class but no section). Because S^4 is simply connected, every vector bundle over S^4 is orientable (Proposition 11.5). For a line bundle orientability implies triviality. Therefore,

$$\text{Vect}_1(S^4) = 0.$$

By (23.14),

$$\text{Vect}_2(S^4) = \pi_3(SO(2))/\mathbb{Z}_2 = \pi_3(S^1)/\mathbb{Z}_2 = 0,$$

$$\text{Vect}_3(S^4) = \pi_3(SO(3))/\mathbb{Z}_2 = \pi_3(\mathbb{R}P^3)/\mathbb{Z}_2$$

$$= \pi_3(S^3)/\mathbb{Z}_2 = \mathbb{Z}/\mathbb{Z}_2.$$

Consequently there is a nontrivial rank 3 vector bundle E over S^4 . The Euler class of E vanishes trivially, since $e(E)$ is in $H^3(S^4) = 0$. If E has a nonzero global section, it would split into a direct sum $E = L \oplus F$ of a line bundle and a rank 2 bundle. Since $\text{Vect}_1(S^4) = \text{Vect}_2(S^4) = 0$, this would imply that E is trivial, a contradiction. Therefore the unit sphere bundle of E relative to some Riemannian metric is an orientable S^2 -bundle over S^4 with zero Euler class but no section. This example shows that the converse of Proposition 11.9 is not true.

REMARK 23.16.1 Actually $\text{Vect}_3(S^4) \simeq \mathbb{Z}$, because the action of \mathbb{Z}_2 on $\pi_3(SO(3))$ is trivial. Indeed, by Remark 23.14.1 this action is induced by the action of $-1 \in O(3)$ under conjugation on $SO(3)$. But conjugating by -1 clearly gives the identity map.

In general, by the same reasoning, if k is odd, then the action of $\pi_0(O(k))$ on $\pi_q(O(k))$ is trivial for all q .

The Infinite Grassmannian

We will now say a few words about vector bundles over manifolds not having a finite good cover. For Theorem 23.10 to hold here the analogue of the finite Grassmannian is the *infinite Grassmannian*. Given a sequence of complex vector spaces

$$\cdots \subset V_r \subset V_{r+1} \subset V_{r+2} \subset \cdots \quad \dim_{\mathbb{C}} V_i = i,$$

there is a naturally induced sequence of Grassmannians

$$\cdots \subset G_k(V_r) \subset G_k(V_{r+1}) \subset G_k(V_{r+2}) \subset \cdots.$$

The infinite Grassmannian $G_k(V_\infty)$ is the telescope constructed from this sequence. Over each $G_k(V_r)$ there are the universal quotient bundles Q_r and there are maps

$$\cdots \subset Q_r \subset Q_{r+1} \subset Q_{r+2} \subset \cdots.$$

By the telescoping construction again there is a bundle Q of rank k over $G_k(V_\infty)$. A point of $G_k(V_\infty)$ is a subspace Λ of codimension k in V and the fiber of Q over Λ is the k -dimensional quotient space V_∞/Λ .

Unfortunately the infinite Grassmannian is infinite-dimensional and so is not a manifold in our sense of the word. Since to discuss infinite-dimensional manifolds would take us too far afield, we will merely indicate how our theorems may be extended. By the countable analogue of the Shrinking Lemma (Ex. 21.4), with the finite cover replaced by a countable locally finite cover, one can show just as in Lemma 23.8 that every vector bundle over an arbitrary manifold M has a collection of countably many spanning sections s_1, s_2, \dots . If V_∞ is the infinite-dimensional vector space with basis s_1, s_2, \dots , there is again a surjective evaluation map at each point p in M :

$$ev_p: V_\infty \rightarrow E_p \rightarrow 0.$$

The kernel of ev_p is a codimension k subspace of V_∞ . So the function $f(p) = \ker ev_p$ sends M into the infinite Grassmannian $G_k(V_\infty)$. This map f is a classifying map for the vector bundle E and there is again a one-to-one correspondence

$$\text{Vect}_k(M; \mathbb{C}) \simeq [M, G_k(\mathbb{C}^\infty)].$$

All this can be proved in the same way as for manifolds of finite type. From Proposition 23.2, it is reasonable to conjecture that the cohomology ring of the infinite Grassmannian $G_k(\mathbb{C}^\infty)$ is the free polynomial algebra

$$\mathbb{R}[c_1(Q), \dots, c_k(Q)].$$

This is indeed the case. (For a proof see Milnor and Stasheff [1, p. 161] or Husemoller [1, Ch. 18, Th. 3.2, p. 269].) Hence Proposition 23.11 extends to a general manifold.

Exercise 23.17. Let V be a vector space over \mathbb{R} and $V^* = \text{Hom}(V, \mathbb{R})$ its dual.

- Show that $P(V^*)$ may be interpreted as the set of all hyperplanes in V .
- Let $Y \subset P(V) \times P(V^*)$ be defined by

$$Y = \{([v], [H]) \mid H(v) = 0, v \in V, H \in V^*\}.$$

In other words, Y is the incidence correspondence of pairs (line in V , hyperplane in V) such that the line is contained in the hyperplane. Compute $H^*(Y)$.

Concluding Remarks

In the preceding sections the Chern classes of a vector bundle E over M were first defined by studying the relations in the cohomology ring $H^*(PE)$ of the projective bundle, where the ring was considered as an algebra over

$H^*(M)$. This somewhat ad hoc procedure turned out to yield all characteristic classes of E only after we learned that all bundles of a given rank were pullbacks of a universal bundle and that the cohomology ring of the universal base space (the classifying space) was generated by the Chern classes of the universal bundle.

From a purely topological point of view one could therefore dispense with the original definition, for by designating a set of generators of the cohomology ring of the classifying space as the universal Chern classes, one can define the Chern classes of any vector bundle simply as the pullbacks via the classifying map of the universal Chern classes. On the other hand, from the differential-geometric point of view the projective-bundle definition is more appealing, starting as it does, with $c_1(S^*)$, a class that we understand rather thoroughly and that furnishes us with a canonical generator for $H^*(PE)$ over $H^*(M)$. However, this c_1 is taken on the space $P(E)$ rather than on M and is therefore not directly linked to the geometry of M . The question arises whether one can write down a form representing $c_k(E)$ in terms of the following data:

- (1) a good cover $\mathcal{U} = \{U_\alpha\}$ of M which trivializes E ;
- (2) the transition functions

$$g_{\alpha\beta} : U_\alpha \cap U_\beta \rightarrow GL(n, \mathbb{C})$$

for E relative to such a trivialization;

- (3) a partition of unity subordinate to the open cover \mathcal{U} .

The answer to this question is yes and the reader is referred to Bott [2] for a thoroughgoing discussion. Here we will describe only the final recipe, for to understand it properly, we would have to explore the concepts of connections and curvature, which are beyond the scope of this book.

Observe first that we are already in possession of the desired formula for the first Chern class of a complex line bundle L (see (6.38)). Indeed, if $g_{\alpha\beta}$ is the transition function for L , the element

$$c^{1,1} = \frac{i}{2\pi} d \log g_{\alpha\beta}$$

in the Čech-de Rham complex $C^*(\mathcal{U}, \Omega^*)$ is both d - and δ -closed. By the collating formula (9.5), once a partition of unity is selected, this cocycle yields a global form. The cohomology class of this global form is $c_1(L)$.

In the general case one can construct a cocycle $\sum_{q=0}^{k-1} c^{k-q, k+q}$, with $c^{k-q, k+q}$ in $C^{k-q}(\mathcal{U}, \Omega^{k+q})$, that represents the k -th Chern class $c_k(E)$ by the following unfortunately rather formidable "averaging" procedure.

Let $I = (i_0, \dots, i_q)$ correspond to a nonvacuous intersection, set

$$U_I = U_{i_0} \cap \dots \cap U_{i_q},$$

and let

$$g_{0j} : U_{i_0} \cap U_{i_j} \rightarrow GL(n, \mathbb{C})$$

be the pertinent transition matrix function for E . Consider the expression

$$\theta_I = \sum_{j=0}^q t_j g_{0j}^{-1} dg_{0j}.$$

as a matrix of 1-forms on $U_I \times \mathbb{R}^{q+1}$, the t 's being linear coordinates in \mathbb{R}^{q+1} . From θ one can construct the matrix of 2-forms

$$K_I = d\theta_I + \frac{1}{2} \theta_I^2$$

on $U_I \times \mathbb{R}^{q+1}$ and set

$$c_I(E) = \det\left(1 + \frac{i}{2\pi} K_I\right).$$

Our recipe is now completed by the following ansatz. Let

$$\Delta_q = \{(t_1, \dots, t_{q+1}) \mid t_j \geq 0, \sum t_j = 1\}$$

be the standard q -simplex in \mathbb{R}^{q+1} . The $2k$ -form $c_I^k(E)$ restricted to $U_I \times \Delta_q$, and integrated over the "fiber Δ_q " yields the desired form on U_I :

$$c_I^{k-q, k+q}(E) = \int_{\Delta_q} c_I^k(E).$$

In other words, $c_k(E)$ is represented by the chain

$$\sum_{q=0}^{k-1} c^{k-q, k+q} \in C^*(U, \Omega^*).$$

Note that for dimensional reasons this chain has no component below the diagonal and also no component in the zero-th column. This fact has interesting applications in foliation theory (Bott [1]). In any case, the colating procedure (9.5) now completes the construction of the forms $c_k(E)$ in terms of the specified data.

References

Alexandroff, P. S. and Hopf, H.

1. *Topologie*, Springer-Verlag, Berlin, 1935; reprinted by Chelsea, New York, 1965.

Bott, R.

1. Lectures on characteristic classes and foliations (Notes by Lawrence Conlon), in *Lectures on Algebraic and Differential Topology*, Springer Lecture Notes in Math. **279** (1972), 1–94.
2. On the Chern–Weil homomorphism and the continuous cohomology of Lie groups, *Advances in Math.* **11** (1973), 289–303.

Bott, R. and Mather, J.

1. Topics in topology and differential geometry, in *Battelle Rencontres: 1967 Lectures in Mathematics and Physics*, edited by C. M. DeWitt and J. A. Wheeler, W. A. Benjamin, New York, 1968.

Croom, F.,

1. *Basic Concepts of Algebraic Topology*, Springer-Verlag, New York, 1978.

Deligne, P., Griffiths, P., Morgan, J., and Sullivan, D.,

1. Real homotopy theory of Kähler manifolds, *Invent. Math.* **29** (1975), 245–274.

Dold, A.

1. *Lectures on Algebraic Topology*, Springer-Verlag, New York, 1972.

Dugundji, J.

1. *Topology*, Allyn and Bacon, Boston, 1966.

Eilenberg, S. and Steenrod, N.

1. *Foundations of Algebraic Topology*, Princeton University Press, Princeton, NJ, 1952.

Flanders, H.

1. *Differential Forms*, Academic Press, New York, 1963.

Gray, B.

1. *Homotopy Theory: an Introduction to Algebraic Topology*, Academic Press, New York, 1975.

Greenberg, M.

1. *Lectures on Algebraic Topology*, W. A. Benjamin, New York, 1966.

Greub, W., Halperin, S., and Vanstone, R.

1. *Connections, Curvature, and Cohomology*, vol. I (De Rham Cohomology of Manifolds and Vector Bundles), Academic Press, New York, 1972.

Guillemin, V. and Pollack, A.

1. *Differential Topology*, Prentice-Hall, Englewood Cliffs, New Jersey, 1974.

Hilton, P. J.

1. On the homotopy groups of the union of spheres, *J. London Math. Soc.* **30** (1955), 154-171.

Hilton, P. J. and Wylie, S.

1. *Homology Theory*, Cambridge University Press, London and New York, 1960.

Hirsch, M.

1. *Differential Topology*, Graduate Text in Math. **33**, Springer-Verlag, New York, 1976.

Hirzebruch, F.

1. *Topological Methods in Algebraic Geometry*, third enlarged ed., Springer-Verlag, New York, 1966.

Hu, S.-T.

1. *Homotopy Theory*, Academic Press, New York and London, 1959.

Husemoller, D.

1. *Fiber Bundles*, second ed., Springer-Verlag, New York, 1975.

Jacobson, N.

1. *Basic Algebra I*, W. H. Freeman and Co., San Francisco, 1974.

Lundell, A. and Weingram, S.

1. *The Topology of CW Complexes*, Van Nostrand Reinhold, New York, 1969.

MacLane, S.

1. *Homology*, Springer-Verlag, New York, 1963.

Massey, W. S.

1. Exact couples in algebraic topology I, II, *Ann. of Math.* **56** (1952), 363-396; **57** (1953), 248-286.
2. *Algebraic Topology: an Introduction*, 4th corrected printing, Springer-Verlag, New York, 1977.

Milnor, J.

1. On spaces having the homotopy type of a CW-complex, *Trans. Amer. Math. Soc.* **90** (1959), 272-280.
2. *Morse Theory*, Princeton University Press, Princeton, NJ, 1963.
3. *Topology from the Differentiable Viewpoint*, University of Virginia Press, Charlottesville, 1965.

Milnor, J. and Stasheff, J. D.

1. *Characteristic Classes*, Princeton University Press, Princeton, NJ, 1974.

Morse, A. P.

1. The behavior of a function on its critical set, *Ann. of Math.* **40** (1939), 62–70.

Mosher, R. E. and Tangora, M. C.

1. *Cohomology Operations and Applications in Homotopy Theory*, Harper and Row, New York, 1968.

Osborn, H.

1. *Vector Bundles*, to be published.

de Rham, G.

1. *Variétés différentiables*, Hermann, Paris, 1960.

Sard, A.

1. The measure of the critical points of differentiable maps, *Bull. Amer. Math. Soc.* **48** (1942), 883–890.

Seifert, H. and Threlfall, W.

1. *A Textbook of Topology*, Academic Press, New York, 1980. (translated from German *Lehrbuch der Topologie* (1934)).

Serre, J.-P.

1. Homologie singulière des espaces fibrés, *Ann. of Math. (2)* **54** (1951), 425–505.
2. Groupes d'homotopie et classes de groupes abélien, *Ann. of Math. (2)* **58** (1953), 258–294.

Simmons, G.

1. *Introduction to Topology and Modern Analysis*, McGraw-Hill, New York, 1963.

Smale, S.

1. Generalized Poincaré's conjecture in dimensions greater than four, *Ann. of Math.* **74** (1961), 391–406.

Spanier, E. H.

1. *Algebraic Topology*, McGraw-Hill, New York, 1966.

Spivak, M.

1. *A Comprehensive Introduction to Differential Geometry*, vol. I, 2nd ed., Publish or Perish, Inc., Berkeley, 1979.

Steenrod, N.

1. *The Topology of Fibre Bundles*, Princeton University Press, Princeton, NJ, 1951.

Sternberg, S.

1. *Lectures on Differential Geometry*, Prentice-Hall, Englewood Cliffs, NJ, 1964.

Sullivan, D.

1. Differential forms and the topology of manifolds, in *Manifolds Tokyo 1973*, (A. Hattori, ed.), University of Tokyo Press, Tokyo, Japan, 1975.
2. Infinitesimal calculations in topology, *Publ. math. I.H.E.S.* **47** (1977), 269–331.

Switzer, R. M.

1. *Algebraic Topology: Homotopy and Homology*, Springer-Verlag, New York, 1975.

Vick, J. W.

1. *Homology Theory*, Academic Press, New York and London, 1973.

van der Waerden, B. L.

1. *Modern Algebra*, 7th ed., Frederick Unger, New York, 1970. (translated from *German Algebra* (1966)).

Warner, F. W.

1. *Foundations of Differentiable Manifolds and Lie Groups*, Scott, Foresman and Company, Glenview, Illinois, 1971.

Weil, A.

1. Sur les théorèmes de de Rham, *Comment. Math. Helv.* 26 (1952), 119–145.

Whitehead, G. W.

1. *Elements of Homotopy Theory*, Springer-Verlag, New York, 1978.

Whitney, H.

1. On maps of an n -sphere into another n -sphere, *Duke Math. J.* 3 (1937), 46–50.
2. *Geometric Integration Theory*, Princeton University Press, Princeton, NJ, 1957.

Singer, I.M. & Thorpe J.A.

Lecture notes on elementary topology and geometry
Scott, Foresman & Company, 1967.

List of Notations*

\mathbb{R}^n	Euclidean n -space 13
\mathbb{R}	field of real numbers 13 real line 34 constant presheaf with the real numbers as the group 112
C^∞	smooth or differentiable 13
I	multi-index 13 unit interval 58 index set 21, 43
\otimes	tensor product 13
$\Omega^*(M)$	de Rham complex 15
\oplus	direct sum 13, 56
d	exterior differentiation 13 coboundary of singular cochains 188
$\tau \wedge \omega$ or $\tau \cdot \omega$	wedge product 14
deg	degree of a form 14 degree of a map 40
$H_{DR}^*(M)$	de Rham cohomology 15
$H^*(M)$	de Rham cohomology (except in §15–§18) 15 singular cohomology (in §15–§18) 189
$[\omega]$	cohomology class of a form 15
ker	kernel 16
im	image 16
f^*	induced map in cohomology 17 pullback map on forms 19
d^*	coboundary 17
Supp	support 18

* Listed by order of appearance in the book, with page numbers following.

$\Omega_c^*(M)$	de Rham complex with compact supports	18
$H_c^*(M)$	compact de Rham cohomology	18
$M - P - Q$	complement of P and Q in M	19
$\text{Hom}(A, B)$	homomorphisms from A to B	20
1_A	identity map from A to A	20
$U \cap V$	intersection	20
θ_{ab}	transition function	20, 48
$\partial f / \partial x_i$	partial derivative	21
$\{\rho_\alpha\}_{\alpha \in I}$	partition of unity	21
$U \cup V$	union	22
$U \amalg V$	disjoint union	22
S^n	n -sphere	24, 36
coker	cokernel	24
$M \times N$	Cartesian product	26
j_*	extension by zero	26
π_*	integration along the fiber	37
e_*	wedge with e	38
f_*	induced map on tangent spaces	42
	induced map on homotopy groups	149, 209
	induced map on homology groups	219
	action of π_1 on π_n	210
γ_*		
$\int_{\mathbb{R}^n} f dx_1 \cdots dx_n $	Riemann integral	27
(x_1, \dots, x_n)	point in \mathbb{R}^n	28
$\text{sgn } \pi$	sign of a permutation	28
$J(T)$	Jacobian determinant $\det(\partial x_i / \partial y_j)$	28
$[M]$	orientation on M	29
∂M	boundary of M	30
\mathbb{H}^n	upper half space	30
$\omega _S$	restriction of a form to a subset	31
K	homotopy operator	34, 94
	differential complex	90
	simplicial complex	142
	cone construction	184
$\ \cdot \ $	length of a vector	36, 123
\mathcal{U}, \mathcal{B}	open covers	42, 43
$\langle \cdot, \cdot \rangle$	Riemannian structure	42
$\mathcal{U} > \mathcal{B}$	\mathcal{U} is refined by \mathcal{B}	43
V^*	dual of a vector space	44
\prod	direct product	46
$E _S$	restriction of a vector bundle to a subset	47
$\text{Diff}(F)$	diffeomorphism group	48
\hookrightarrow	inclusion map	50
$[\eta_S]$	Poincaré dual of S	51
$\text{GL}(n, \mathbb{R})$	real general linear group	53

$GL(n, \mathbb{C})$	complex general linear group 54
$\Gamma(U, E)$	group of sections of a vector bundle over U 54
$GL^+(n, \mathbb{R})$	n by n real matrices with positive determinant 54
T_M	tangent bundle of a manifold 55
$T_x M$	tangent space to M at the point x 55
$O(n)$	orthogonal group 55
$SO(n)$	special orthogonal group ¹ 55
f^t	transpose 56
$f^{-1}E$	pullback bundle 56
$\text{Vect}_k(M)$	isomorphism classes of real rank k vector bundles 57
$\text{Vect}_k(M; \mathbb{C})$	isomorphism classes of complex rank k vector bundles 299
$\text{Iso}(V, W)$	isomorphisms from V to W 57
$D(f)$	Jacobian matrix 60
$\Omega_{cv}^*(E)$	forms with compact support in the vertical direction 61
$H_{cv}^*(E)$	compact vertical cohomology 61
\mathcal{F}	Thom isomorphism 64
$\Phi(E)$	Thom class of an oriented vector bundle 64, 65
$N_{S/M}$	normal bundle of S in M 66
T	tubular neighborhood 66
codim	codimension 69
ψ	angular form 70, 71, 121
E^0	complement of the zero section of a vector bundle 71
$e(E)$	Euler class 72, 117
CP^n	complex projective space 75
CP^∞	infinite complex projective space 242
\mathbb{C}^n	complex n -space 53
$[z_0, \dots, z_n]$	homogeneous coordinates on complex projective space 75
$[a, b]$	closed interval from a to b 18
(a, b)	open interval from a to b
	point in \mathbb{R}^2 151
	bidegree 164
	greatest common divisor 194
$\Omega^*(f)$	relative de Rham complex 78
$H^*(f)$ or $H^*(M, S)$	relative de Rham cohomology 78, 79
$H^q(f)$	induced map in cohomology 261
$\Lambda^q E$	exterior power 80, 278
$\Omega^*(M, E)$	differential forms with values in a vector bundle 79
$\Omega^*(M, E), d_\phi$	complex of E -valued forms relative to a trivialization 80
sgn	sign function 84

L	orientation bundle 84
$\Lambda^* T_M^* \otimes L$	density bundle 85
$C^*(U, \Omega^*)$	Čech-de Rham complex 89
δ	difference operator 90, 93, 110
D	Čech boundary operator 186
D''	differential operator on the Čech-de Rham complex 90, 95
$H_D\{C^*(U, \Omega^*)\}$	$(-1)^p d$ 90
r	Čech-de Rham cohomology 91
$U_{\alpha\beta}$	restriction 91
$U_{\alpha\beta\gamma}$	pairwise intersection 92
∂_i	triple intersection 92
$\omega_{\alpha_0 \dots \alpha_p}$	inclusion 92
$C^*(U, \mathbb{R})$	component of ω 93
$H^*(U, \mathbb{R})$	Čech complex with coefficients in the constant presheaf \mathbb{R} 97
$N(U)$	Čech cohomology of an open cover 97
$\mathbb{R}P^n$	nerve of a cover 100
$\pi^{-1}U$	real projective space 77, 105, 241
ρ_V^U	inverse cover 106
$\text{Open}(X)$	restriction from U to V 109
$\mathcal{H}^q, \mathcal{H}^q(F)$	category of open sets and inclusions 109
$C^p(U, \mathcal{F})$	cohomology presheaf of a fibration 109
$H_0 C^*(U, \mathcal{F})$ or $H^*(U, \mathcal{F})$	p -chains on an open cover with values in a presheaf 110
$H^*(X, \mathcal{F})$	Čech cohomology of an open cover 110
$S(E)$	Čech cohomology 110
$\det E$	unit sphere bundle 114
ε	determinant bundle 116
\sum	Čech cocycle representing the Euler class 116
$\chi(M)$	sum 116
Δ	Euler characteristic 126
$C^*(\pi^{-1}U, \Omega_{cv}^*)$	diagonal 127
$H_{cv}^{p,q}$	Čech-de Rham complex with compact vertical supports 130
\mathcal{H}_{cv}^q	elements of degree (p, q) in d -cohomology 130
\mathcal{H}_c^q	compact vertical cohomology presheaf 130
K'	compact cohomology functor 141
$\pi_1(K)$	first barycentric subdivision of a simplicial complex 142
$\pi_1(X)$	edge path group of a simplicial complex 146
$ K $	fundamental group of a topological space 147
$N_2(U)$	support of a simplicial complex 142
$S^1 \vee S^2$	2-skeleton of nerve 148
	wedge 153, 262

$\{K_p\}$	filtration 156
GK	associated graded complex 156
$\{E_r, d_r\}$	cohomology spectral sequence 159
E_∞	stationary value of spectral sequence (if it exists) 160
$E_r^{p,q}$	(p, q) -component of cohomology spectral sequence 164
$\{F_p\}$	induced filtration on cohomology 164, 165
Z	ring of integers 112 constant presheaf with the integers as the group 191
Z_m	integers mod m 168
$h^p(F)$	dimension of the cohomology vector space $H^p(F)$ 170
$\omega \cup \eta, \omega \cdot \eta, \omega \eta$	cup product 174
$R[x]$	polynomial algebra over R with one generator 177
$R[x]/(x^3)$	quotient of polynomial algebra by an ideal 177
R^∞	infinite Euclidean space 183
Δ_q	standard q -simplex 183
$S_q(X)$	singular q -chains 183
∂_q^i	i -th face map of the standard q -simplex 183
∂	boundary operator 184
$H_*(X)$ or $H_*(X; Z)$	singular homology with integer coefficients 184
$H_*(X; G)$	singular homology with coefficients in G 184
$S_*^u(X)$	u -small chains 185
$S^q(X)$	singular q -cochains 188
$H^*(X; G)$	singular cohomology with coefficients in G 189
Ext	"extension" functor 193
Tor	"torsion" functor 193
F_q	free part of integer homology $H_q(X)$ 194
T_q	torsion part of integer homology $H_q(X)$ 194
G/H	coset space 195
$\pi_q(X)/\pi_1(X)$	the quotient of $\pi_q(X)$ by the action of $\pi_1(X)$ 211
$U(n)$	unitary group 196
$\{E^r, d^r\}$	homology spectral sequence 197
$E_r^{p,q}$	(p, q) -component of homology spectral sequence 197
$P(X)$ or PX	path space with base point $*$ 198
$\Omega(X)$ or ΩX	loop space with base point $*$ 199
$\Omega_x X$	loop space with base point x 1, 210
$\pi_q(X)$	q -th homotopy group with base point $*$ 206
$\pi_q(X, x)$	q -th homotopy group with base point x 1, 210
\bar{x}	constant map with image x 1, 210
I^q	q -dimensional unit cube 147, 208

I^q or ∂I^q	the faces of a cube 149, 208
$[f]$	homotopy class of a map 208
Ω_*^A	all paths from $*$ to A 21
$\pi_q(X, A)$	relative homotopy group 213
e^n	closed unit disk of dimension n 217
$X \cup_f e^n$	space with a cell attached to it 217
$H(f)$	Hessian 220
	Hopf invariant 228
A'	transpose of a matrix 220
M_a	set of level at most a 221
∇h	gradient of a function 221
$[G, G]$	commutator subgroup 225
$[X, Y]$	homotopy classes of maps satisfying no base point condition 211, 299
$\text{link}(A, B)$	linking number of A and B 229
M°	interior of a manifold with boundary 232
\equiv	is identically equal to 232
$K(A, n)$	Eilenberg–MacLane space 240
$\mathbb{R}P^n$	real projective space 77, 105, 241
$\mathbb{R}P^\infty$	infinite real projective space 241
S^∞	infinite sphere 242
$L(n, q)$	Lens space 243
$L(\infty, q)$	infinite Lens space 243
\mathbb{Q}	field of rational numbers 245
M_f	mapping cylinder of f 249
$\Lambda(x_1, \dots, x_k)$	free algebra generated by x_1, \dots, x_k 259
A^+	elements of positive dimension in a differential graded algebra 259
\mathcal{M}	minimal model 259
$P(E)$ or PE	projectivization 268, 269
$E_{\mathbb{R}}$	underlying real vector bundle 267
\hat{V}	universal product bundle 268, 292
S	universal subbundle 268, 270, 292
S_E	universal subbundle on $P(E)$ 271
Q	universal quotient bundle 268, 270, 292
Q_E	universal quotient bundle on $P(E)$ 274
$P_i(M)$	Poincaré series 269, 294
$PGL(n, \mathbb{C})$	projective general linear group 269
$c_i(E)$	i -th Chern class 270
$c(E)$	total Chern class 270
$F(E)$	split manifold 273
$S^p V$	symmetric power 279
$L(E)$	L -class 279
$Td(E)$	Todd class 279
H	hyperplane bundle 282

$E^{\otimes k}$	tensor product of k copies of the bundle E	282
$Fl(V)$	flag manifold	282
$Fl(E)$	associated flag bundle	282
$(f = 0)$	ideal generated by the homogeneous components of f	283
\bar{V}	conjugate vector space	286
\bar{E}	conjugate vector bundle	286
$L \otimes \mathbb{C}$	complexification	286
$p_i(E)$	i -th Pontrjagin class	289
$p(E)$	total Pontrjagin class	289
$G_k(V)$	Grassmannian of codimension k subspaces	292
ev_p	evaluation map	298
$G_k(V_\infty)$ or $G_k(\mathbb{C}^\infty)$	infinite Grassmannian of codimension k subspaces	302

Index

- Abelian group
 - structure of a finitely generated Abelian group 9
- Action (*See also* Action of π_1 on π_q)
 - adjoint action 301
 - effective action 48
- Action of π_1 on π_q 211
 - for the orthogonal groups 302
- Adjoint action 301
- Algebra (*See also* Graded algebra)
 - divided polynomial algebra 205
 - exterior algebra 205
 - free algebra 259
- Alternating difference 110
- Alternating sum formula 186
- Angular form 70
 - global angular form 121, 122
- Antiderivation 14, 174, 175
- Antipodal map 75
- Associated flag bundle 282
 - cohomology ring 284
 - Poincaré series 285
- Associated graded complex 156
- Atlas 20
- Attaching cells 217
 - CW-complex 219
 - homology property 219
 - homotopy property 217
- Averaging 213, 304

- Back r -face 192
- Barycenter 142

- Barycentric subdivision 142
- Base points
 - dependence of homotopy groups on 210
- Bidegrees
 - in a cohomology spectral sequence 164
 - in a homology spectral sequence 197
- Blow-up 268
- Bott, Raoul 304, 305
- Boundary 30
 - induced map on 18
 - of a manifold 30
- Boundary map
 - Čech boundary operator 186
 - for singular chains 184
 - in homotopy sequence 209, 254
- Brown, Edgar 10
- Bump form 25, 40, 68
- Bundle map 54

- Cartan, Henri 5
- Category 20
 - of commutative differential graded algebras 20
 - of differentiable manifolds 20, 59
 - of Euclidean spaces 20
 - of open sets 109
 - of topological spaces 59, 182
- Čech boundary operator 186
- Čech cochains
 - with values in a presheaf 110

- Čech cohomology
 is isomorphic to the Čech-de Rham cohomology 98
 is isomorphic to the de Rham cohomology 98, 104, 112
 is the same for all good covers 99
 of a circle 100
 of an open cover 97, 99, 110
 of a space 112
 with values in a presheaf 110
 Čech-de Rham complex 96
 Čech-de Rham isomorphism
 as an application of the Mayer-Vietoris principle 98
 as graded algebras 175
 explicit formula for 104
 spectral sequence proof of 166
 tic-tac-toe proof of 138
 Čech-singular complex
 in cohomology 190
 in homology 196, 197
 Chain homotopic 34
 Chain-homotopy inverse 104
 Chain map 17
 Characteristic classes 8, 266 (See also Chern classes; Euler class; Pontrjagin classes)
 Chern classes 267, 270, 304
 are the only cohomological invariants of a complex vector bundle 299
 as generators of the cohomology ring of a Grassmannian 293
 first Chern class 267
 in terms of the patching data 304
 naturality 271
 of a complex projective space 281
 of a direct sum 272
 of a hypersurface 282
 of a symmetric power 279
 of a tensor product 279
 of a trivial bundle 271
 of an exterior power 278, 279
 of the dual bundle 280
 top Chern class is the Euler class 272, 278
 universal Chern classes 304
 Whitney product formula 272, 275
 Chern, Shing-shen 8, 266
 Circle
 as an Eilenberg-MacLane space 240
 Čech cohomology 100
 cohomology with coefficients in a presheaf 112
 compact cohomology 27
 de Rham cohomology 24
 Leray's construction 180
 locally constant presheaf on 143
 nontrivial 1-cocycle on 101, 181
 universal covering of 152
 Classification
 of bundles over a sphere 301
 of complex vector bundles 299
 of real vector bundles 300
 Classifying map 298, 303
 Closed forms 15
 Closed homology 52
 Closed Poincaré dual 51
 is not the same as the compact Poincaré dual 52
 Clutching function 301
 Coboundary operator
 for compact supports 139
 in a long exact sequence 17, 161
 of a singular cochain 189
 Cochains 110
 Cocycle condition 48, 54
 Cofinal 43
 Cohomology (See also Čech cohomology; Compact cohomology; de Rham cohomology; Product structures; Singular cohomology)
 of a differential complex 16
 twisted de Rham cohomology 85
 with coefficients in a covariant functor 110
 with coefficients in a presheaf 112
 Cohomology presheaf 109
 Collar 232
 Collating formula 102
 Commutativity in the graded sense 20, 259
 Commutator 2
 Commutator subgroup 225
 Compact cohomology 18, 26
 Künneth formula 50
 of a vector bundle 59-61, 65
 of a Euclidean space 18, 19, 39
 of the circle 27
 of the open Möbius strip 40, 60, 141
 Compact homology 52
 Compact open topology 1, 198
 Compact supports 17, 25 (See also Compact cohomology)
 coboundary 139
 Mayer-Vietoris sequence 26, 139
 Compact Poincaré dual 51, 230, 232
 is not the same as closed Poincaré dual 52

- Compact vertical cohomology 61
 Compact vertical supports 61
 Complex Grassmannian 292 (See also
 Infinite complex Grassmannian)
 and the classification of complex vector
 bundles 299–301
 as a homogeneous space 292
 cohomology ring 293
 homotopy groups 300
 Poincaré polynomial 292
 tautological sequence 292
 universal bundles 292
 Complex line bundle 267
 first Chern class 267
 Complex manifold 280
 holomorphic tangent bundle 280
 Pontrjagin class 290
 Complex projective line
 generator in cohomology 236
 standard orientation 237
 Complex projective space 75, 77, 138,
 260, 268
 Complex vector bundle 54
 Chern classes 280
 cohomology 172, 268
 generator in cohomology 138, 177
 holomorphic tangent bundle 281
 hyperplane bundle 268
 infinite (See Infinite complex
 projective space)
 open cover on 138
 Poincaré series 269
 product bundle 268
 ring structure 176
 tautological bundles 268
 tautological exact sequence 268
 universal quotient bundle 268
 universal subbundle 268
 Complexification 286
 Composite morphism 20
 Composition of loops 1, 206
 Cone construction 184
 Conjugate vector bundle 286
 is isomorphic to the dual bundle
 286
 Conjugate vector space 286
 Connected component 2, 189
 Constant presheaf 109, 132, 141
 not every locally constant presheaf
 is 109
 Contractible 36
 Contravariant functor 20
 presheaf 109
 presheaf on an open cover 142
 Convention
 on indices 93
 on signs (See Sign convention)
 on subscripts and superscripts 92, 197
 Convergence of a spectral sequence 160
 Covariant-functor 20
 cohomology with coefficients in 110
 Covering homotopy property 199, 202,
 209
 Covering space 209, 240 (See also
 Universal covering)
 Coordinate open cover 21
 Coulomb potential 8
 Critical point 40, 42, 220
 nondegenerate critical point 220
 Critical value 40, 42, 220
 Cup product 192
 Curl 14
 CW-approximation theorem 226
 CW-complex 219
 every manifold has the homotopy type of
 a CW-complex 220
 good cover 219
 has the homotopy type of a simplicial
 complex 219
 is homotopy equivalent to a space with a
 good cover 219
 skeleton 219

D-coboundary 96
D-cochain 96
D-cocycle 95
 de Rham, George 6
 De Rham complex 15, 19
 with compact supports 18
 De Rham cohomology 15, 19 (See also
 Singular cohomology)
 explicit isomorphism with Čech
 cohomology 104
 finite-dimensionality of 43, 99
 homotopy invariance 24
 in the top dimension 87
 is isomorphic to the Čech
 cohomology 98, 167, 175 (See also
 Čech–de Rham isomorphism)
 of a complex Grassmannian 293
 of a complex projective space 172,
 173, 177, 269
 of a fiber bundle 170 (See also
 Leray–Hirsch theorem)
 of a flag bundle 285
 of a flag manifold 285
 of a manifold 87

- DeRham cohomology (*cont.*)
 of a projective bundle 270, 283
 of a real projective space 78
 of a Riemann surface 5
 of a vector bundle 60, 61
 of an infinite complex
 Grassmannian 303
 of an open Möbius strip 40, 138
 of an open set in \mathbb{R}^n 15
 of an orientable manifold 47, 87
 of \mathbb{R}^n 16, 35
 of the circle 24
 of the n -sphere 36
 twisted de Rham cohomology 85
 with compact supports (See Compact cohomology)
 with compact supports in the vertical direction 61
 with values in a flat vector bundle 80
- De Rham–Čech isomorphism (See Čech–de Rham isomorphism)
- Decomposable 259
- Deformation retraction 36
 invariance of de Rham cohomology under 36
- Degenerate at the E_r term 166
- Degree
 and Hopf invariant 234
 local 123
 of a hypersurface 282
 of a proper map (See Degree of a proper map)
 of a 0-chain 184
- Degree of a proper map
 between compact oriented manifolds 47
 between Euclidean spaces 40
 between spheres 215
 is an integer 41
- Density 85
 integration of 86
- Density bundle 85
 transition functions 85
- Derived couple 155
 stationary 158
- Diagonal
 normal bundle is isomorphic to the tangent bundle 127
 Poincaré dual of 127
 self-intersection number 128
- Difference operator 110 (See also Alternating difference; Coboundary operator; Differential operator)
- Differentiable function on a manifold 21
- Differential in a spectral sequence 162, 164
- Differential complex 16, 156
- Differential forms (See also Forms)
 on a Euclidean space 13
 on a manifold 21
 with values in a vector bundle 80
 with values in a vector space 79
- Differential graded commutative algebra (See Differential graded algebra)
- Differential graded algebra 259
 existence of a minimal model 260
 1-connected 260
- Differential operator 13, 16
 in the Mayer–Vietoris sequence 93
 on a double complex 90, 162, 164
- Diluting a bundle 291
- Dimension of a filtration 160
- Direct limit 112
- Direct product
 Chern classes of 267, 272
 dual is not always a direct sum 46
 of vector bundles 56
- Direct sum
 Chern classes of 279
 dual is a direct product 46
 of vector bundles 56
- Direct sum orientation 66
- Direct system of groups 112
- Directed set 43
- Divergence 14
- Divided polynomial algebra 205
- Double complex 90 (See also Čech–de Rham complex; Čech-singular complex)
 differential operator on 90, 162, 164
 filtration on 156
 spectral sequence of 165
- Dual 56 (See also Dual bundle; Poincaré dual)
- Dual bundle 56
 and conjugate bundle 286
 Chern classes of 267, 280
- Edge homomorphism 178
- Edge path group 147
- Effective action 48
- Eilenberg–Steenrod axioms 5
- Eilenberg–MacLane space 9, 240, 250
 $K(\mathbb{Z}, 1)$ 240
 $K(\mathbb{Z}, 2)$ 242

- $K(\mathbb{Z}, 3)$ 245
- $K(\mathbb{Z}_2, 1)$ 242
- $K(\mathbb{Z}_q, 1)$ 243
- rational cohomology ring 245
- Elementary symmetric functions 278
- Embedding a manifold 290
- Endpoint map 252
- Equivalent cocycles 54
- Equivalent oriented trivializations 54
- Euclidean space
 - compact cohomology 39
 - de Rham cohomology 35
 - infinite Euclidean space 183
 - singular cohomology 189
 - singular homology 185
- Euler characteristic 126
 - is equal to the Euler number 128
 - of a fiber bundle 182
- Euler class 72, 116
 - and spectral sequences 171
 - and the top Chern class 273
 - functoriality 74
 - in terms of the transition functions 73
 - in the Gysin sequence 179
 - is independent of good covers 118
 - is Poincaré dual to the zero locus of a section 125
 - is the pullback of the Thom class 132
 - naturality 74
 - of an oriented S^{2n} -bundle 126
 - of an oriented vector bundle 118
 - of the normal bundle of CP^1 in CP^2 of the 2-sphere 125
 - Whitney product formula 133
- Euler number 122
 - and local degree 124
 - is equal to the Euler characteristic 128
 - is the self-intersection of the diagonal 128
- Evaluation map 298, 303
- Exact couple 155, 158
- Exact forms 15
- Exact sequence
 - of set maps 209
 - of vector bundles 65
 - of vector spaces 17
- Ext 193–194
- Extension principle 147
- Extension problem 167
- Exterior algebra 205
- Exterior differentiation 14
- Exterior derivative 14
 - is an antiderivation 14
- Exterior power 278
 - Chern classes of 278, 279
- Face map 183
- Fiber 47, 48, 199
 - connectedness 202
 - homotopy type 200
- Fiber bundle 47
 - cohomology (See Leray–Hirsch theorem)
 - spectral sequence of 169
- Fibered space 199
 - as a basic trick of the trade 249
 - in the sense of Hurewicz 199
 - in the sense of Serre 199
- Fibration 199 (See also Fibered space)
- Filtered complex 156
 - spectral sequence of 156
- Filtration 156
 - induced filtration 159
 - length 159
 - on a double complex 156
- Finite type 42
- Finite-dimensionality of de Rham cohomology 43, 99
- Finitely generated Abelian group 9
- First homotopy group 1 (See also Fundamental group; Homotopy groups)
- Five Lemma 44
- Fixed-point formula
 - of Lefschetz 129
- Flag 282
- Flag bundle 282
 - cohomology ring 285
 - is a split manifold 282
 - Poincaré series 285
- Flag manifold 282
 - cohomology ring 284
 - obtained from the Grassmannian by two flag constructions 293
 - Poincaré polynomial 285
- Flat vector bundle 80
 - cohomology with coefficients in 80
- Forms with compact support 8, 25
 - integration of 29
- Forms with compact support in the vertical direction 61
- Frame 54
- Free homotopy class 211
- Free resolution 193
- Front r -face 192

- Functor 20, 109 (See also Contravariant functor; Covariant functor)
 Functoriality (See Naturality)
 Fundamental group 1, 206 (See also Homotopy groups)
 of a Riemann surface 1, 240
 of the nerve of a good cover 148
 of the support of a simplicial complex is the edge path group 147
- G**-bundle 48
 General linear group 56
 Generator 40
 for the cohomology of a circle 24
 for the cohomology of a complex projective space 236
 for the cohomology of a sphere 37
 for the compact cohomology of a Euclidean space 40
 Geodesically convex neighborhood 43
 Global angular form 71, 73, 121, 124
 formula for 122
 God-given set of differential equations 15
 God-given vector bundles 268
 Good covers 42
 are cofinal 43, 190
 on a manifold 42
 on a topological space 147
 on a triangularizable space 190
 on the torus 105
 Graded algebra (See also Differential graded algebra)
 commutativity 20
 Poincaré series 294
 Gradient 3, 14, 221
 Grassmannian (See Complex Grassmannian; Infinite complex Grassmannian; Real Grassmannian)
 Griffiths, Philip A. 262
 Grothendieck, Alexander 266
 Gysin sequence 177
- Helicoid 268
 Hessian 220
 Hilton, Peter 265
 Hirzebruch, F. 280
 Hirzebruch–Riemann–Roch theorem 280
 Hirzebruch signature formula 290
 Holomorphic section 282
 Holomorphic tangent bundle 280
 Hom functor 56, 169
 exactness of 169
- Homogeneous coordinates 75
 Homogeneous space 292
 Homology 183 (See also Singular homology)
 relation with homotopy 225
 Homology Mayer–Vietoris sequence 188
 Homology spectral sequence 196
 Homomorphism of presheaves 109
 Homotopy 35
 between continuous and differentiable maps 213
 Homotopy axiom for de Rham cohomology 35
 Homotopy exact sequence (See Homotopy sequence)
 Homotopy groups 2, 206
 higher homotopy groups are Abelian 207
 in the C^∞ sense and in the continuous sense 214
 of a bouquet of circles 240
 of a Cartesian product 207
 of a Riemann surface 240
 of a sphere (See Homotopy groups of a sphere)
 of a wedge of spheres 265
 of an Eilenberg–MacLane space 240
 of the circle 240
 of the infinite real projective space 241
 relation with homology 225
 relative homotopy groups 213
 Homotopy groups of a sphere 214, 215
 Hurewicz isomorphism 227
 $\pi_3(S^3)$ 256
 $\pi_4(S^3)$ 251
 $\pi_3(S^2)$ 227
 Serre's theorem 254, 262
 Homotopy invariance of de Rham cohomology 5, 24
 Homotopy operator 34
 for the compact Poincaré lemma 38
 for the generalized Mayer–Vietoris sequence 94
 for the Poincaré lemma 34
 Homotopy property of vector bundles 57
 Homotopy sequence
 of a fibering 209
 relative homotopy sequence 213
 Homotopy type
 in the C^∞ sense 36
 of a CW-complex 219
 of a manifold 220
 of the fiber of a fibering 200
 Hopf, Heinz 7, 227, 266

- Hopf invariant 228
 degree definition 234
 differential form definition 230
 homotopy invariance 228
 Hopf fibration 235
 intersection-theory definition 229
 of $f: S^{2n-1} \rightarrow S^n$ is zero for odd n 228
 Hopf fibration 227
 fiber over ∞ 238
 fiber over 0 238
 Hopf invariant 235
 Hopf index theorem 129
 Hurewicz
 fibering in the sense of 199
 Hurewicz isomorphism theorem 225
 Hurewicz, W. 2
 Hypersurface in a complex projective space 282
 Chern classes of 282
- Incidence correspondence 303
 Inclusion 249
 Index
 of a nondegenerate critical point 220
 of a zero of a vector field 128
 Index theorem
 Atiyah–Singer 1
 Hopf 129
 Indices
 convention on 93
 Induced filtration 159
 Induced map
 in cohomology corresponds to pre-image
 in geometry 69
 in homotopy 210
 on the boundary 18
 Induced orientation on the boundary 31
 Infinite complex Grassmannian 302
 cohomology ring 303
 Infinite complex projective space 242
 cohomology ring 243
 Infinite-dimensional manifold 303
 Infinite Euclidean space 183
 Infinite lens space 243
 Infinite real projective space 241
 cohomology ring 245
 has no higher homotopy 241
 is the infinite Lens space $L(\infty, 2)$ 243
 Infinite sphere 242
 has no homotopy 242
 Integral 3, 27
 Integration
 of a density 86
 of a differential form 27
- Integration along the fiber 37, 61–63
 commutes with d 38, 62
 in the Gysin sequence 179
 Invariant form on a sphere 77
- Jacobian determinant 28
 Jacobian matrix 60, 220, 223, 224
- Kernel of a set map 209
 Kill
 to get killed 177
 Killing homotopy groups 250
 Künneth formula
 algebraic Künneth formula 173
 finiteness hypothesis 108
 for the compact cohomology 50
 for the de Rham cohomology 47
 for the singular cohomology 192
 Mayer–Vietoris argument 47
 spectral sequence proof 170
 tic-tac-toe proof 106
- L-class 279
 Hirzebruch signature formula 290
 Lefschetz fixed-point formula 129
 Lefschetz number 129
 Length of a filtration 159
 Lens space 243
 cohomology 244
 Leray–Hirsch theorem 50
 for the singular cohomology 192
 Mayer–Vietoris argument 50
 spectral sequence proof 170
 tic-tac-toe proof 108
 Leray, Jean 5, 10
 Leray's construction 179
 Leray's theorem
 for the de Rham cohomology 170
 for the singular cohomology 192
 Lie group 196, 208, 292
 Line bundle 115
 Chern class of the dual line bundle 2
 Chern class of a tensor product of line bundles 267
 complex line bundle 267
 Line integral 3
 Linking number 229
 Live to the E_r term 163
 Local compatibility condition 114
 Local degree of a section 123
 Local product orientation 61

- Localization principle 53, 67
 Locally constant presheaf 109
 on an open cover 143
 with group Z_2
 Locally constant sections 80
 Locally constant trivialization 80
 Locally finite open refinement 58
 Long exact sequence 17, 157
 coboundary operator in 17
 derived couple 157
 of homotopy groups 209
 Loop space 1, 199
 homotopy groups 208
 of a sphere (See Loop space of a sphere)
 of an Eilenberg–MacLane space 241
 Loop space of a sphere
 integer cohomology 203
 ring structure 204
- Manifold** 4, 20
 existence of a good cover on 42
 homotopy type of 220, 224
 is paracompact 58
 of finite type 42
 orientable \iff has a global nowhere vanishing top form 29
 orientable \iff tangent bundle is orientable 55
 simply connected \implies orientable 116
Manifold with boundary 30 (See also Surface with boundary)
- Map between spheres**
 degree 215
 Hopf invariant 227
 normal form 216
Mapping cylinder 249
Massey, William 155
Mathematical physics 8
Mayer–Vietoris argument 42
 finite-dimensionality of de Rham 43
 for the singular cohomology 193
 Künneth formula 47
 Leray–Hirsch theorem 50
 Poincaré duality 44–46
 Thom isomorphism 52
Mayer–Vietoris sequence 4, 22
 for compact supports 26, 139
 for countably many open sets 94
 for singular chains 186
 for singular cochains 189
 for two open sets 22, 89
 generalized 94
 homology Mayer–Vietoris sequence for two open sets 188
Mayer–Vietoris principle
 as a consequence of the tic-tac-toe lemma 138
 generalized 96
 spectral sequence proof of 166
Measure zero 41, 42
Milnor, John 220, 221, 222, 226
Minimal model 259
 existence of 260
 main theorem 262
Möbius band 7 (See also open Möbius strip)
Möbius strip (See open Möbius strip)
Morgan, John 262
Morse, A. P. 41
Morse function 223, 224
Morse lemma 222
Morse theory 220
 main theorems 221, 222
Monodromy representation 146
Morphism 20
Multiplicity
 of a fixed point 129
 of a zero 125
- Natural transformation** 109, 300
Naturality
 Chern class 271
 Euler class 74
 n -connected 253
Nerve of an open cover 100
Nondegenerate critical point 220
Nondegenerate pairing 44
Nonorientable Poincaré duality 87, 141
Nonorientable Thom isomorphism 88, 131
Normal bundle 66
 of CP^1 in CP^2 75
 of the diagonal is isomorphic to the tangent bundle 127
 of the zero locus of a transversal section 133
Normal form of a map between two spheres 216
- Object** 20
Obstruction theory 123
 l -connected 261
Open collar 232
Open cover
 Čech cohomology of 97, 99, 110

- coordinate open cover 21
- good cover 42
- Open Möbius strip
 - compact cohomology 40, 60, 141
 - de Rham cohomology 40, 138
- Orientability
 - a simply connected manifold is orientable 171
 - of a manifold 29
 - of a sphere bundle (See Orientability of a sphere bundle)
 - of a vector bundle 115
- Orientability of a sphere bundle 114
 - spectral sequence point of view 171
- Orientable manifold 29
- Orientable sphere bundle (See Oriented sphere bundle)
- Orientable vector bundle 54 (See also Oriented vector bundle)
 - over an orientable manifold 60
- Orientation
 - direct sum orientation 66
 - local product orientation 61
 - on a manifold 29
 - on a sphere bundle 114
 - on a vector bundle 55
 - on the normal bundle of an oriented submanifold 66
 - on the zero locus of a section 134
 - product orientation 123
- Orientation bundle
 - of a manifold 84
 - of a vector bundle 88
- Orientation-preserving map 28
- Oriented manifold 29
- Oriented sphere bundle 114, 171
 - cohomology 177
 - Euler class 72, 116, 171
 - Gysin sequence 177
 - orientation 114
- Oriented vector bundle 54, 60
 - Euler class 118
- Orthogonal group (See also Special orthogonal group)
 - reduction to 55
 - stable homotopy groups of 239
- Paracompact space 58
- Parallel translation 125
- Partition of unity 4, 21
- Path components 1, 189, 208
 - and connected components 208
- Path fibration 199, 225
- Path space 198
- Physics 8
- Poincaré conjecture 147
- Poincaré dual 51, 230 (See also Closed Poincaré dual; Compact Poincaré dual)
 - is the Thom class of the normal bundle 67
 - localization principle 53, 67
 - of a circle on a torus 68
 - of a closed oriented submanifold 51
 - of a point 68
 - of a transversal intersection 69
 - of the ambient manifold 68
 - of the diagonal 127
 - of the Euler class 125
 - of the pullback of a form 69
 - of the zero locus of a section 125
 - support of 67
- Poincaré, Henri 5, 6
- Poincaré duality 44
 - and the Thom isomorphism 60, 67
 - nonorientable 87, 141
- Poincaré lemma 16, 35
 - for compact supports 19, 39
 - for compact vertical supports 63
- Poincaré polynomial (See also Poincaré series)
 - of a Grassmannian 293
- Poincaré series 269, 296, 297
 - of a complex Grassmannian 292
 - of a complex projective space 269
 - of a flag bundle 285
 - of a flag manifold 285
 - of a graded algebra 294
 - of a projective bundle 271
- Pontrjagin classes 289
 - application to the embedding of a manifold 290
 - of a sphere 290
 - sign convention 289, 290
- Pontrjagin, Lev S. 8, 266
- Positive form 70
- Postnikov approximation 250, 251
 - in the computation of homotopy groups 9, 10, 256
 - in the computation of $\pi_4(S^3)$ 256, 25
 - in the computation of $\pi_4(S^3)$ 251, 252
- Postnikov tower 250
- Presheaf 108
 - cohomology presheaf 109
 - constant presheaf 109, 141, 177
 - homomorphism of presheaves 109
 - locally constant on an open cover 14
 - locally constant presheaf 109, 141, 17

- Presheaf (*cont.*)
 of compact vertical cohomology 131
 on an open cover 142
 trivial presheaf 109
- Product bundle
 over a Grassmannian 292
 over a projective space 268
- Product orientation 123
- Product structure
 on a tensor product 176
 on the Čech complex 174
 on the Čech-de Rham complex 174
 on the de Rham complex 14
 on the singular cohomology 191
- Projective general linear group 269
- Projective plane
 real projective plane 105
- Projective space (See Complex projective space; Infinite complex projective space; Infinite real projective space; Real projective space)
- Projectivization of a vector bundle 269
 cohomology ring 270, 283
 pullback bundle 270
 tautological exact sequence 270
 universal quotient bundle 270
 universal subbundle 270
- Projection formula 63
- Proper map 26
 degree 40, 41
 image is closed 41
 not surjective \Rightarrow degree is zero 41
- Pullback
 commutes with d 19
 in the Gysin sequence 179
 of a differential form 19
 of a vector bundle 56
- Quadratic transformation 268
- Rational homotopy theory 259
 main theorem 262
- Real Grassmannian 292
 and the classification of vector bundles over a sphere 301
 as a homogeneous space 292
 homotopy groups 300
- Real projective plane 105
 good cover on 105
- Real projective space 77, 241 (See also Infinite real projective space; Real projective plane)
 de Rham cohomology of 78
- Real vector bundle 53
- Realization 267, 286
 of a complex matrix 287
 of a complex vector bundle 267, 286
- Reduction of the structure group 54
 and orientability 55
 to the orthogonal group 55
 to the unitary group 267
- Refinement 43
- Regular sequence 295, 296
- Regular value 40, 224, 229
- Relative de Rham cohomology 79
- Relative de Rham theory 78
- Relative homotopy group 213
- Relative homotopy sequence 213
- Restriction 109
- Retraction 36
- Riemann integral 27
- Riemann-Roch theorem 280
- Riemann surface 1
 as an Eilenberg-MacLane space 240
 de Rham cohomology of 5
 homotopy groups of 2, 240
- Riemannian structure 42
- Sard, A. 41
- Sard's theorem 41, 42, 215, 218, 224
- Second spectral sequence 166
- Section
 and the Euler class 119, 302
 existence of 122, 272
 existence \Rightarrow zero Euler class 119
 partial section 122
 singularities of 122
- Serre
 fibering in the sense of 199
- Serre, Jean-Pierre 10, 227
- Serre's theorem on the homotopy groups of the spheres 254, 262
- Short exact sequence 17
- Shrinking lemma 276, 303
- Sign convention
 general principle 174
 indices 93
 Pontrjagin classes 289, 290
- Signature 290
- Signature formula of Hirzebruch 290
- Singular chain 183
- Singular cochain 188
- Singularities of a section 122
 local degree 123
- Simplex
 barycenter 142
 barycentric subdivision 142

- standard q -simplex 183
- Simplicial approximation theorem 147
- Simplicial complex 142
 - good cover on 190, 220
 - k -skeleton 142
 - support of 142
- Simplicial map 146
- Singular cohomology 189
 - and Čech cohomology 189, 191
 - of a Euclidean space 189
 - of a fiber bundle 192
 - of a flag bundle 285
 - of a flag manifold 285
 - of a lens space 243, 244
 - of a special orthogonal group 195, 196
 - of a unitary group 196
 - of an Eilenberg–MacLane space 245–248
 - of $K(\mathbb{Z}, 3)$ 245
 - of the infinite complex projective space 243
 - of the infinite real projective space 245
 - of the loop space of a sphere 203
 - of the unit tangent bundle of a sphere 194
- Singular homology 184
 - of a Euclidean space 185
- Skeleton
 - of a CW-complex 219
 - of a simplicial complex 142
- Spanning sections 298
- Special orthogonal group 55, 195
 - action of π_1 on π_q 302
 - and orientability 55
 - and the classification of vector bundles 302
 - identification of $SO(3)$ with $\mathbb{R}P^3$ 195
 - integer cohomology of $SO(4)$ 195
 - integer cohomology of $SO(3)$ 195
 - reduction to 55
- Spectral sequence 159
 - and the Euler class 171
 - Čech–de Rham isomorphism 167, 175
 - convergence 160
 - differential 161–164
 - exact couples 155
 - Künneth formula 170
 - Leray–Hirsch theorem 170
 - Mayer–Vietoris principle 167
 - product structures 174
 - of a double complex (See Spectral sequence of a double complex)
 - of a fiber bundle 169
 - of a filtered complex 160
 - orientability 171
 - orientability of a simply connected manifold 171
 - Spectral sequence of a double complex 161
 - differential 162, 164
 - second spectral sequence 166
- Sphere
 - Čech cohomology of 102
 - cohomology of 36
 - Euler class of the tangent bundle of 125
 - generator in the top dimension of 37
 - homotopy groups 214, 215, 227
 - invariant form on 77
 - minimal model 259, 260
 - Serre's theorem on the homotopy groups of 254, 262
 - tangent bundle (See Tangent bundle of a sphere)
 - unit tangent bundle of the 2-sphere is $SO(3)$ 195
 - volume form on 37, 235
- Sphere bundle (See also Oriented sphere bundle)
 - orientation 114
 - structure group 113
- Spherical coordinates 238
- Split manifold 273, 275
 - is the flag bundle 283
- Splitting
 - of a G -module 194
 - of a vector bundle 274
- Splitting principle 275
 - in the computation of Chern classes 279
 - in the proof of the Whitney product formula 277
- Stable homotopy groups
 - of the orthogonal group 239
 - of the unitary group 239
- Star 142, 190, 220
- Standard orientation
 - on a sphere 70
 - on CP^1 237
- Standard q -simplex 183
- Stationary derived couples 158
- Steenrod, Norman 123
- Stereographic projection 235
- Stiefel, Eduard 266
- Stokes' theorem 31
 - for densities 86
- Stone, A. H. 58
- Structure group 47
 - of a complex vector bundle 54, 267
 - of a fiber bundle 47

- Structure group** (*cont.*)
 of a real vector bundle 53
 of a sphere bundle 113
 of an orientable vector bundle 55
 reduction of (See Reduction of the structure group)
Subcomplex 156
Subdivision
 barycentric 142
Sullivan, Dennis 259, 263
Support
 of a form 24
 of a function 18
 of a simplicial complex 142
Surface with boundary 231
Sylvester's theorem 220
Symmetric function theorem 278
Symmetric power 279
 Chern classes of 279

Tangent bundle 55
 holomorphic tangent bundle 280
 of a sphere (See Tangent bundle of a sphere)
Tangent bundle of a sphere
 cohomology 194
 Euler class 125
 unit tangent bundle of the 2-sphere is $SO(3)$ 195
Tangent space 21
Tangent vector field (See Vector field)
Tautological exact sequence
 over a Grassmannian 292
 over a projective bundle 270
 over a projective space 268
Telescoping construction 241
 infinite complex projective space 242
 infinite Grassmannian 302
 infinite Lens space 243
 infinite real projective space 241
 infinite sphere 242
Tensor product
 exactness 169
 Chern classes of 267, 279
 of vector bundles 56
 product structure 176
Thom class 64, 232
 a characterization of 64
 as a relative cohomology class 78
 in terms of the global angular form 74, 132
 in terms of the patching data 75
 of a direct sum 65
 pulls back to the Euler class 74, 132
 relation to the Poincaré dual 67
Thom isomorphism 63
 and Poincaré duality 60
 nonorientable 88, 131
3-sphere 243
 $\pi_4(S^3)$ 251
 $\pi_5(S^3)$ 257
Tic-tac-toe lemma 135
Tic-tac-toe proof
 of Poincaré duality 141
 of the generalized Mayer–Vietoris principle 138
 of the Künneth formula 105
 of the Leray–Hirsch theorem 108
Todd class 279
Tor functor 193, 194
Torsion 9, 182, 194
Torus 221
 good cover on 105
Total space 48
Total Chern class 270 (See also Chern classes)
Total Pontrjagin class 289 (See also Pontrjagin classes)
 of a complex manifold 290
 of a sphere 290
Transition functions
 for a fiber bundle 48
 for a manifold 20
 for a vector bundle 53
 for the conjugate bundle 286
 for the density bundle 85
 for the direct sum 56
 for the dual bundle 56
 for the tensor product 56
 reduction of the structure group 54
Transgression 247
Transgressive element 247
Transversal intersection 68, 69
 codimension is additive 69
 is dual to the wedge product 69
 normal bundle of 69
Transversality theorem 123
Triangularizable space 190
 good covers are cofinal 190
Triangulation 190
 of a manifold 190
Tricks
 basic tricks in homotopy theory 249
Trivial presheaf 109
Trivialization
 and transition functions 54

- of a coordinate open cover 21
 - locally constant 80
- Tubular neighborhood 65, 214
- Tubular neighborhood theorem 66
- Twisted cohomology 80, 82
 - and trivialization 80, 83
 - invariant under the refinement of open covers 82
- Twisted de Rham cohomology 84
 - is the same as the de Rham cohomology on an orientable manifold 85
- Twisted de Rham cohomology with compact supports 84
- Twisted de Rham complex 85

- Unit sphere bundle 114
- Unit tangent bundle of a sphere
 - cohomology of 195
- Unitary group 196, 292
 - integer cohomology of 196
 - reduction of the structure group to 267
 - stable homotopy groups of 239
- Universal Chern classes 304
- Universal coefficient theorems 194
- Universal covering 252
 - of a circle 152
- Universal quotient bundle
 - and the cohomology of a Grassmannian 293
 - classification of vector bundles 298
 - over a Grassmannian 292, 298
 - over a projective bundle 270
 - over a projective space 268
- Universal subbundle 77, 270
 - over a Grassmannian 292
 - over a projective bundle 270
 - over a projective space 268
- Upper half space 30
- \mathbb{N} -small chain 185

- Vector bundles (See also oriented vector bundle)
 - classification 299
 - cohomology 60
 - compact cohomology 60, 65
 - compact vertical cohomology 61, 63
 - complex vector bundle 54
 - Euler class 72, 118
 - exact sequence of 65
 - flat 80
 - God-given 268
 - isomorphic \iff cocycles are equivalent 54
 - orientability of 54
 - orientable \iff associated sphere bundles are 115
 - orientable \iff determinant bundles are 116
 - over a contractible manifold 59
 - over a simply connected manifold 116
 - over a sphere 302
 - real vector bundle 53
 - reduction of the structure group 54, 267
 - splitting of 274
 - to "dilute" a vector bundle 291
 - unit sphere bundle of 114
- Vector field 21
 - Hopf index theorem 129
 - index of a zero 128
 - on a sphere 125
- Volume integral 3
- Volume form
 - on a sphere 27
 - on the 2-sphere 235

- Wedge of spheres 153, 262
 - minimal model 263
 - ranks of the homotopy groups 265
- Wedge product of differential forms 14
 - is Poincaré dual to a transversal intersection 69
- Weil, André 5, 10, 89
- Whitehead tower 252, 253, 257
- Whitney embedding theorem 213
- Whitney, Hassler 7, 217, 266
- Whitney product formula
 - for the Chern class 272, 275
 - for the Euler class 133
 - for the L -class 279
 - for the Pontrjagin class 289
 - for the Todd class 279

- Yang-Mills 8

- Zero locus of a section
 - normal bundle of 133
 - orientation on 134
 - Poincaré dual of 134
- Zig-zag 95

Interdependence of the Sections

