

Differentiable Topology and Geometry

April 8, 2004

These notes were taken from the lecture course "Differentiable Manifolds" given by Mladen Bestvina, at University of Utah, U.S., Fall 2002, and \LaTeX -ed by Adam Keenan.

Contents

| | | |
|----------|-------------------------------|-----------|
| 1 | Introduction | 4 |
| 2 | Tangent Spaces | 16 |
| 2.1 | Differentiation | 18 |
| 2.2 | Curve Definition | 19 |
| 2.3 | Derivations | 20 |
| 2.4 | Immersions | 24 |
| 2.5 | Submersions | 30 |
| 2.6 | Grassmannians | 36 |
| 3 | Transversality Part I | 37 |
| 4 | Stability | 41 |
| 5 | Imbeddings | 45 |
| 5.1 | Sard's Theorem | 45 |
| 6 | Transversality Part II | 47 |
| 7 | Partitions of Unity | 49 |
| 8 | Vector Bundles | 53 |
| 8.1 | Tangent Bundle | 53 |
| 8.2 | Cotangent Bundle | 54 |
| 8.3 | Normal Bundle | 54 |

| | | |
|-----------|--|------------|
| 8.4 | Vector Bundles | 60 |
| 9 | Vector Fields | 69 |
| 9.1 | Lie Algebras | 72 |
| 9.2 | Integral Curves | 73 |
| 9.3 | Lie Derivatives | 79 |
| 10 | Morse Theory | 83 |
| 11 | Manifolds with Boundary | 89 |
| 12 | Riemannian Geometry | 97 |
| 12.1 | Connections | 100 |
| 12.2 | Collars | 101 |
| 13 | Intersection Theory | 105 |
| 13.1 | Intersection Theory mod 2 | 105 |
| 13.2 | Degree Theory mod 2 | 110 |
| 13.3 | Orientation | 114 |
| 13.4 | Oriented Intersection Number | 121 |
| 13.5 | Mapping Class Groups | 123 |
| 13.6 | Degree theory | 126 |
| 14 | Vector Fields and the Poincaré–Hopf Theorem | 129 |
| 14.1 | Algebraic Curves | 137 |
| 15 | Group Actions and Lie Groups | 139 |
| 15.1 | Complex Projective Space | 140 |
| 15.2 | Lie Groups | 143 |
| 15.3 | Fibre Bundles | 146 |
| 15.4 | Actions of Lie Groups | 147 |
| 15.5 | Discrete Group Actions | 147 |
| 15.6 | Lie Groups as Riemannian Manifolds | 149 |
| 16 | The Pontryagin Construction | 150 |
| 17 | Surgery | 155 |
| 18 | Integration on Manifolds | 157 |
| 18.1 | Multilinear Algebra and Tensor products | 157 |
| 18.2 | Forms | 160 |
| 18.3 | Integration | 163 |

| | |
|---|------------|
| 18.4 Exterior derivative | 165 |
| 18.5 Stoke's theorem | 167 |
| 19 de Rham Cohomology | 171 |
| 19.1 Mayer-Vietoris Sequence | 175 |
| 19.2 Thom Class | 189 |
| 19.3 Curvature | 190 |
| 20 Duality | 192 |
| 21 Subbundles and Integral Manifolds | 195 |

1 Introduction

We all know from multivariable calculus what it means for a function $f: \mathbb{R}^n \rightarrow \mathbb{R}^m$ to be smooth. We would like to extend this definition to spaces other than Euclidean ones. Is there a reasonable definition of smoothness for a function $f: X \rightarrow Y$? Since smoothness is a local condition these spaces X and Y should look like Euclidean spaces locally. This motivates the definition of a smooth manifold.

Definition 1.0.1. A topological space M is a *topological manifold* if:

- (1) M is a Hausdorff space.
- (2) For all $x \in M$ there exists an open neighbourhood U_x of x and a homeomorphism $U_x \cong \mathbb{R}^{n(x)}$ for some $n(x)$.

Example 1.0.1. \mathbb{R}^n (as well as any open set in \mathbb{R}^n) with the standard topology is a topological manifold.

Example 1.0.2. If we give S^1 the subspace topology of \mathbb{R}^2 , then it is certainly a Hausdorff space. Now consider the following four subspaces of S^1 :

$$\begin{aligned}U_1 &= \{(x, y) \in S^1 : x > 0\}, \\U_2 &= \{(x, y) \in S^1 : x < 0\}, \\U_3 &= \{(x, y) \in S^1 : y > 0\}, \\U_4 &= \{(x, y) \in S^1 : y < 0\}.\end{aligned}$$

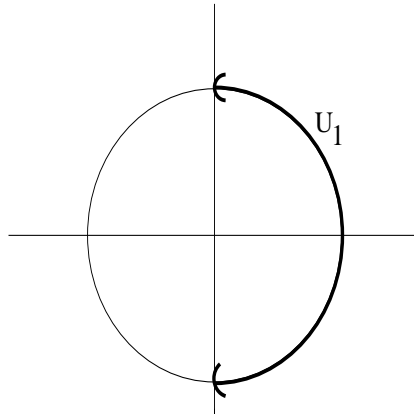

All of these subspaces are homeomorphic to $(-1, 1)$, for example, the homeomorphism ϕ_1 from U_1 to $(-1, 1)$ is given by $\phi_1(x, y) = y$. Now $(-1, 1)$ is homeomorphic to \mathbb{R} , hence each U_i is homeomorphic to \mathbb{R} . Since each point in S^1 lies in one of these subspaces we have that S^1 is a topological manifold.

Lemma 1.0.1. *Any open set of a topological manifold is a topological manifold.*

Theorem 1.0.1 (Invariance of Domain). *Let $U \subseteq \mathbb{R}^n$ be an open set and $f: U \rightarrow \mathbb{R}^n$ be a continuous injective map. Then $f(U)$ is open in \mathbb{R}^n .*

We shall give a proof of this later on in the notes.

Corollary 1.0.1. *If $n \neq m$, then an open set in \mathbb{R}^n cannot be homeomorphic to an open set in \mathbb{R}^m .*

In the definition $n(x)$ is well-defined by invariance of domain. Also, $n(x)$ is locally constant. Hence if the manifold is connected, then $n(x)$ is constant on the whole manifold. In which case the *dimension* of the manifold is defined to be $n(x)$.

Lemma 1.0.2. *Let M and N be topological manifolds. Then $M \times N$ is also a topological manifold.*

Proof. From basic topology we know that $M \times N$ is a Hausdorff space. Let $(p_1, p_2) \in M \times N$. Then there exists open neighbourhoods U_1 and U_2 , containing p_1 and p_2 respectively, and a homeomorphism ϕ_i from U_i to \mathbb{R}^{n_i} . Therefore $\phi_1 \times \phi_2$ is a homeomorphism from $U_1 \times U_2$ to $\mathbb{R}^{n_1+n_2}$. \square

Example 1.0.3. The torus $T^2 = S^1 \times S^1$ is a topological manifold.

Why do we want Hausdorff in the definition?

Example 1.0.4 (A non-Hausdorff manifold). Let $M = (-\infty, 0) \cup (0, \infty) \cup \{0^+\} \cup \{0^-\}$, with the standard topology on $(-\infty, 0) \cup (0, \infty)$. A basis of neighbourhoods of 0^+ is $\{(-\epsilon, 0) \cup (0, \epsilon) \cup \{0^+\}\}$, where $\epsilon > 0$. A basis of neighbourhoods of 0^- is $\{(-\epsilon, 0) \cup (0, \epsilon) \cup \{0^-\}\}$, where $\epsilon > 0$.

$\bullet 0^+$

$\bullet 0^-$

Notice that in this space there is a sequence with a nonunique limit. Thus, we need the Hausdorff condition to guarantee unique limits.

Example 1.0.5. Let $M = \{(x, y) \in \mathbb{R}^2 : xy = 0\}$. If we give M the induced topology from \mathbb{R}^2 , then M is a Hausdorff topological space. But it is not a topological manifold because there is no neighbourhood of the origin homeomorphic to an open set in \mathbb{R}^n .

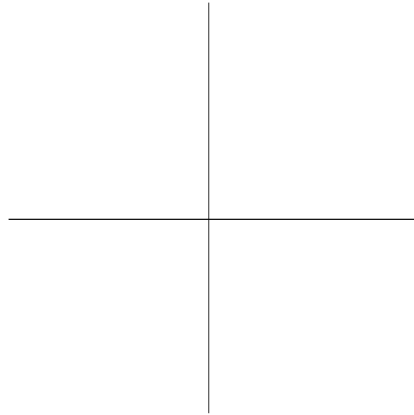

Proposition 1.0.1. *For a topological manifold the following are equivalent:*

- (1) *each component is σ -compact;*
- (2) *each component is second countable;*
- (3) *M is metrisable;*
- (4) *M is paracompact.*

Consider the Natural numbers with the order topology. Now take $\mathbb{N} \times [0, 1)$, this space is given the lexicographical ordering. What you end up with is the half line with the standard topology. The half long line occurs when you replace the natural numbers by a well-ordered uncountable set.

Example 1.0.6 (The Long Line). An example of a topological manifold which fails these conditions is the long line. Let $\Omega =$ set of all countable ordinals. This is well-ordered and uncountable. Let $M = \Omega \times [0, 1)$ with the lexicographical order. The order topology on M is the half long line. The space $M \amalg M / (0, 0) \sim (0, 0)$ is called the long line.

Example 1.0.7 (Real Projective Space). We define $\mathbb{R}P^n$ as a set to be $S^n/x \sim -x$ (This is equivalent to the space of lines through the origin in

\mathbb{R}^{n+1}). If we give $\mathbb{R}P^n$ the quotient topology, then $\mathbb{R}P^n$ becomes a topological space. So how do we make this into a manifold? One can check that with this topology $\mathbb{R}P^n$ is a Hausdorff space. Now for each x we have to find a neighbourhood homeomorphic to an open set in \mathbb{R}^n . Let $U_i^+ = \{(x_0, x_1, \dots, x_n) \in S^n : x_i > 0\}$ and $U_i^- = \{(x_0, x_1, \dots, x_n) \in S^n : x_i < 0\}$. Then

$$U_i^\pm \cong \{(x_0, x_1, \dots, x_{i-1}, \tilde{x}_i, x_{i+1}, \dots, x_n) : x_0^2 + x_1^2 + \dots + \tilde{x}_i^2 + \dots + x_n^2 < 1\},$$

where \tilde{x}_i just means that the term is omitted. It is clear that U_i^\pm is homeomorphic to an open set in \mathbb{R}^n . Now let $U_i \subset \mathbb{R}P^n$ be the image under the quotient map $\pi: S^n \rightarrow \mathbb{R}P^n$ of U_i^+ (or U_i^-). Then $\pi^{-1}(U_i) = U_i^+ \cup U_i^-$. In order to show that $\pi: U_0^+ \rightarrow U_0$ is a homeomorphism we need to show that the inverse is continuous. Let $[x, -x] \in U_0$ with $x = (x_0, x_1, \dots, x_n)$. We may assume $x_0 > 0$ by replacing x by $-x$ if necessary. Now define $\rho: U_0 \rightarrow U_0^+$ by $\rho([x, -x]) = x$. The composition $\rho \circ \pi: U_0^+ \cup U_0^- \rightarrow U_0^+$ is continuous, hence ρ is continuous.

Remark: $\mathbb{R}P^1$ is homeomorphic to S^1 and the homeomorphism is given by $[z, -z] \rightarrow z^2$. This map is continuous because the map $S^1 \rightarrow S^1$ given by $z \rightarrow z^2$ is continuous.

$$\begin{array}{ccc} S^1 & & \\ \downarrow \pi & \searrow z \rightarrow z^2 & \\ \mathbb{R}P^1 & \xrightarrow{[z, -z] \rightarrow z^2} & S^1 \end{array}$$

The map is a homeomorphism since S^1 is compact.

The fact that $\mathbb{R}P^1$ is homeomorphic to S^1 should be clear geometrically.

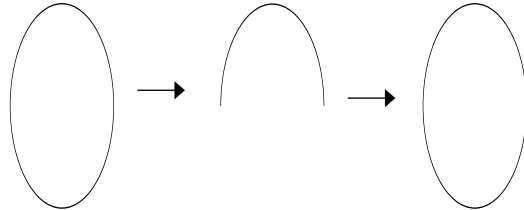

From now on a topological manifold will be a topological manifold which is metrisable. For spaces that are Hausdorff and metrisable one can construct partitions of unity (which we shall define later). This is an indispensable tool in differentiable topology.

Definition 1.0.2. Let M be a topological manifold. A *chart* on M is a homeomorphism $\phi: U \rightarrow \phi(U) \subseteq \mathbb{R}^n$, where $U \subseteq M$ is open, $\phi(U)$ is open in \mathbb{R}^n .

Definition 1.0.3. Two charts $\phi: U \rightarrow \phi(U)$ and $\psi: V \rightarrow \psi(V)$ are C^∞ related if

$$\psi \circ \phi^{-1}: \phi(U \cap V) \rightarrow \psi(U \cap V)$$

and

$$\phi \circ \psi^{-1}: \psi(U \cap V) \rightarrow \phi(U \cap V)$$

are both C^∞ .

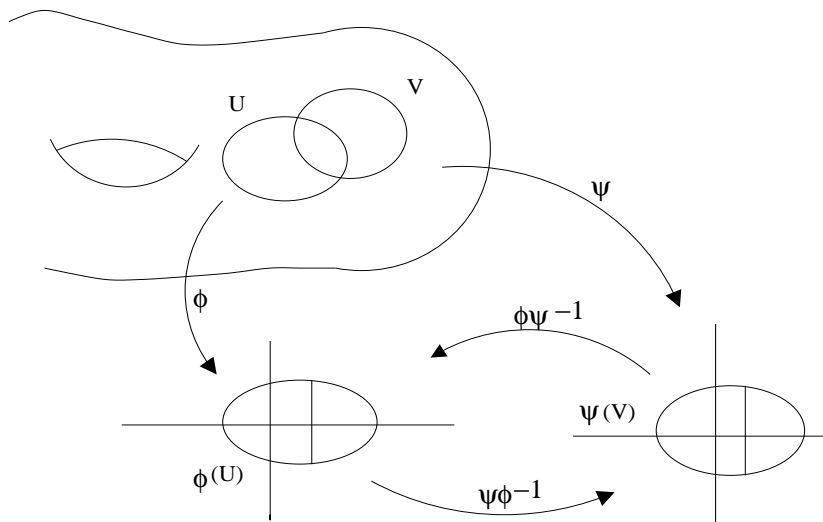

Remark: The map $\mathbb{R} \rightarrow \mathbb{R}$ given by $x \rightarrow x^3$ is a C^∞ homeomorphism but the inverse given by $x \rightarrow x^{1/3}$ is not C^∞ (it is not even C^1).

Definition 1.0.4. An *atlas* on M is a family $\{(U_i, \phi_i)\}$ of charts, such that $\{U_i\}$ is an open cover of M , and any two charts are C^∞ related.

Example 1.0.8. Let $M = \mathbb{R}^n$, and let $U = \mathbb{R}^n$. Define the function $\phi: U \rightarrow \mathbb{R}^n$ to be the identity. Then $\{(U, \phi)\}$ is an atlas.

Lemma 1.0.3. Every atlas is contained in a unique maximal atlas.

Proof. Define $\tilde{A} = \{(U, \varphi): (U, \varphi) \text{ is } C^\infty\text{-related to all charts in } A\}$. Then clearly $A \subset \tilde{A}$. If B is any atlas that contains A , then $\tilde{A} \supset B$. The only thing we need to show is that \tilde{A} is an atlas. Take U, V two charts in \tilde{A} .

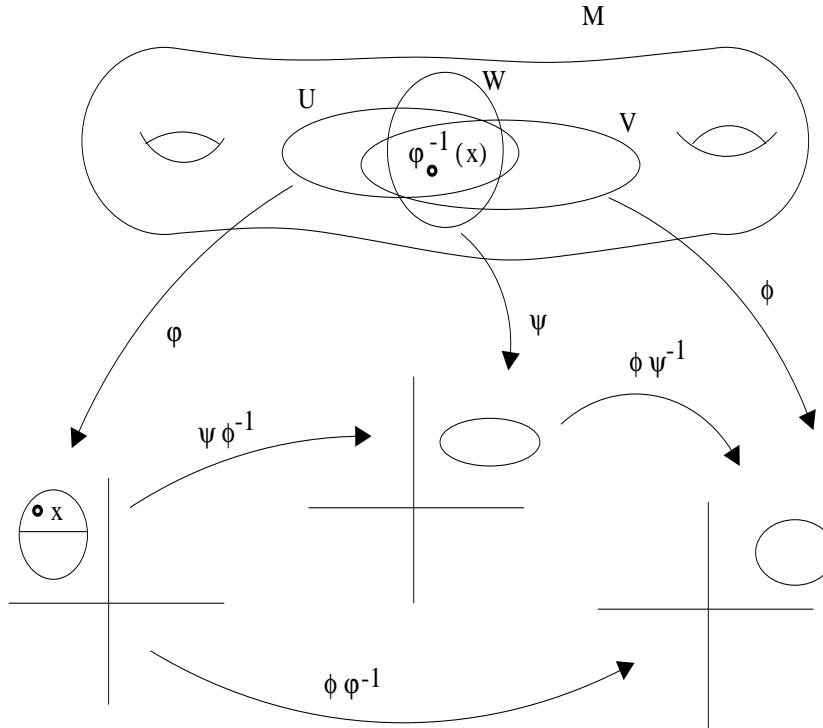

We want to show $\phi \circ \varphi^{-1}$ is smooth. To do this we write $\phi \circ \varphi^{-1} = (\phi \circ \psi^{-1}) \circ (\psi \circ \varphi^{-1})$, which is the composition of two smooth maps. Hence \tilde{A} is an atlas. \square

Definition 1.0.5. A C^∞ (you could say smooth) manifold is a pair (M, A) , where M is a topological manifold and A is a maximal atlas.

Example 1.0.9. We saw earlier that S^1 was a topological manifold. We shall now show that two of the charts are C^∞ equivalent, and leave it to the reader to verify that all the others are C^∞ equivalent. Take the charts (U_1, ϕ_1) and (U_3, ϕ_3) . The transition function $\phi_1 \circ \phi_3^{-1}: \phi_3(U_1 \cap U_3) \rightarrow \phi_1(U_1 \cap U_3)$ is the map $x \rightarrow \sqrt{1-x^2}$, which is a smooth map as $0 < x < 1$. Hence S^1 is a smooth manifold.

Definition 1.0.6. Let M and N be two smooth manifolds. A continuous map $f: M \rightarrow N$ is *smooth* at x if for some (equivalently, any) chart (U, φ) , $x \in U$ and some (equivalently, any) chart (V, ψ) , $f(x) \in V$ such that $f(U) \subseteq V$ the function $\psi \circ f \circ \varphi^{-1}$ is C^∞ in a neighbourhood of $\varphi(x)$.

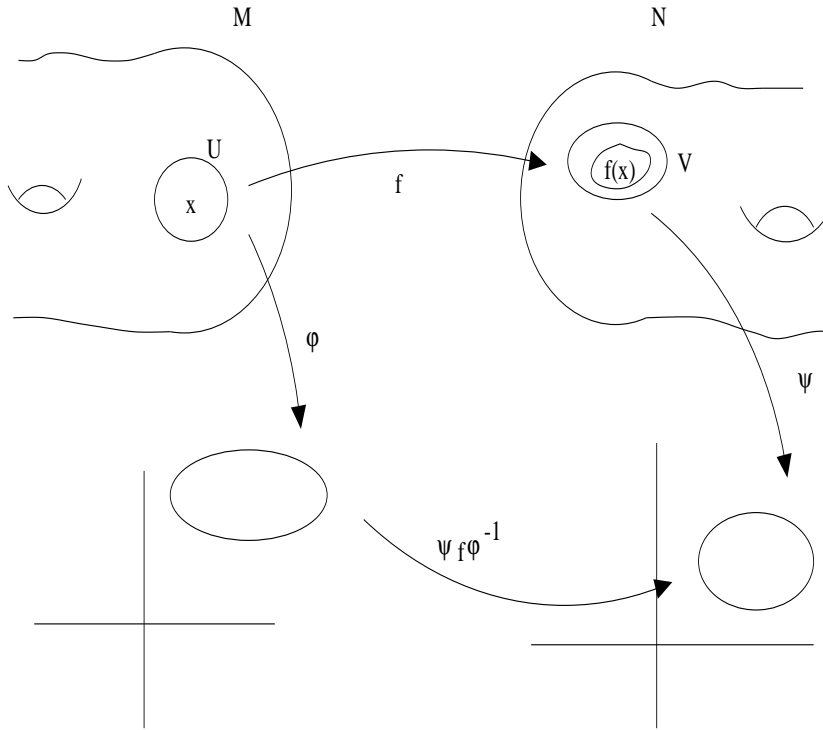

Definition 1.0.7. A function f is smooth if, and only if, it is smooth at every point.

We leave the reader to check the following:

- (1) $id: M \rightarrow M$ is smooth.
- (2) If $f: X \rightarrow Y$ and $g: Y \rightarrow Z$ are both smooth, then the composition $g \circ f: X \rightarrow Z$ is also smooth.

Remark: This gives us a category, where the objects are smooth manifolds and the morphisms are smooth maps.

Example 1.0.10. The topological manifold \mathbb{R} can be given two chart maps $\phi: \mathbb{R} \rightarrow \mathbb{R}$ and $\psi: \mathbb{R} \rightarrow \mathbb{R}$ given by $\phi(x) = x$ and $\psi(x) = x^3$. As we mentioned earlier these two chart maps are not C^∞ equivalent, hence this gives us two differentiable structures on \mathbb{R} . Let $M = (\mathbb{R}, (\phi, \mathbb{R}))$ and $N = (\mathbb{R}, (\psi, \mathbb{R}))$. Is $id: N \rightarrow M$ smooth? The answer is no, since the map $x \rightarrow x^{1/3}$ is not smooth.

The remaining question is are these two smooth manifolds N and M diffeomorphic. The answer is yes and the diffeomorphism $N \rightarrow M$ is given by $x \rightarrow x^3$.

Remark: No matter what differentiable structure we put on \mathbb{R}^n , it will always be diffeomorphic to \mathbb{R}^n with the standard differentiable structure, except for the case when $n = 4$.

Example 1.0.11. Let $C = \{(x, y, z) \in \mathbb{R}^3 : z = x^2 + y^2\}$ (the cone). We give C the subspace topology. Consider the map which projects C onto the $x = y$ plane. Then C becomes a smooth manifold with differentiable structure $(C, (C, proj))$.

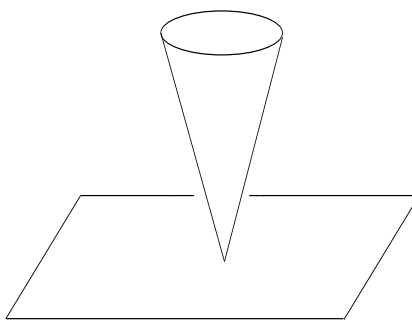

Remark: The cone is not a regular surface in \mathbb{R}^3 because of the cone point singularity.

Now for an alternative approach. Let $X \subseteq \mathbb{R}^n$ be a set (It does not have to be open). We say a function $f: X \rightarrow \mathbb{R}^m$ is smooth if it can be locally extended to smooth functions on open sets, that is, if for all $x \in X$ there exists $U \subset \mathbb{R}^n$ (open) and $f_U: U \rightarrow \mathbb{R}^m$ smooth, with $f_U = f$ on $U \cap X$.

Example 1.0.12. Let X be the square in the plane, and let $f: X \rightarrow \mathbb{R}$ be given by $f(x, y) = x$. Then f can be extended to the whole plane with the same formula.

From now on instead of writing smooth manifold, we shall just say manifold.

Definition 1.0.8. Let $X \subseteq \mathbb{R}^n$, and let $Y \subseteq \mathbb{R}^m$. We say that $f: X \rightarrow Y$ is a *diffeomorphism* if f is a homeomorphism and both f and f^{-1} are smooth.

Example 1.0.13. Let $X = \{(x, y) \in \mathbb{R}^2 : xy = 0, x, y \geq 0\}$. Then X is not diffeomorphic to the real line. Suppose we have a diffeomorphism $f: X \rightarrow \mathbb{R}$.

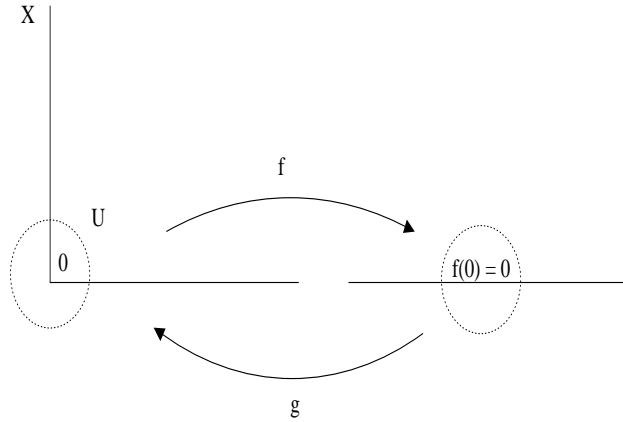

Let $h = g \circ f$. Then h is defined and smooth in a neighbourhood of the origin, with $h = id$ on X . The derivative $dh_0: \mathbb{R}^2 \rightarrow \mathbb{R}^2$ is given by the matrix

$$\begin{pmatrix} \frac{\partial h_1(0)}{\partial x_1} & \frac{\partial h_1(0)}{\partial x_2} \\ \frac{\partial h_2(0)}{\partial x_1} & \frac{\partial h_2(0)}{\partial x_2} \end{pmatrix},$$

which is the identity matrix. This implies that $dh_0 = dg_0 \circ df_0$ is the identity. Hence df_0 is injective. But the matrix of df_0 is given by:

$$\begin{pmatrix} \frac{\partial f_1(0)}{\partial x_1} & \frac{\partial f_2(0)}{\partial x_1} \\ \frac{\partial f_1(0)}{\partial x_2} & \frac{\partial f_2(0)}{\partial x_2} \end{pmatrix},$$

which shows that df_0 is not injective.

Example 1.0.14. The Möbius band (without boundary) is obtained by considering the circle $x^2 + y^2 = 4$ and the open interval AB given in the yz plane by $y = 2, |z| < 1$. We move along the centre c of AB along S^1 and turn AB about c in the the cz plane in such a manner that when c has passed through the angle u , AB has rotated by an angle $u/2$.

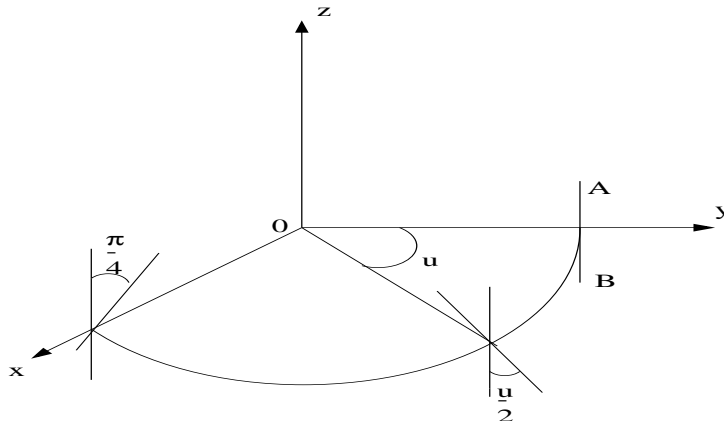

A local parametrisation for the Möbius band is given by

$$\phi(\theta, t) = \left((2 - t \sin(\frac{\theta}{2})) \sin \theta, (2 - t \sin(\frac{\theta}{2})) \cos \theta, t \cos(\frac{\theta}{2}) \right),$$

where $0 < \theta < 2\pi$ and $-1 < t < 1$. The corresponding coordinate neighbourhood omits the points of the open interval $\theta = 0$. We obtain another parametrisation given by

$$\psi(\theta, t) = \left((2 - t \sin(\frac{\pi}{4} + \frac{\theta}{2})) \cos \theta, - (2 - t \sin(\frac{\pi}{4} + \frac{\theta}{2})) \sin \theta, t \cos(\frac{\pi}{4} + \frac{\theta}{2}) \right),$$

which coordinate neighbourhood omits the interval $\theta = \frac{\pi}{2}$. These two coordinate neighbourhoods cover the Möbius strip and can be used to show that the Möbius band is a surface.

The following lemma enables one to check whether a subset of Euclidean space is a manifold:

Lemma 1.0.4. *Suppose that $f: \mathbb{R}^n \rightarrow \mathbb{R}$ is smooth and $X = f^{-1}(0)$. Then X is a manifold if $df_x: \mathbb{R}^n \rightarrow \mathbb{R}$ is not zero for $x \in X$, i.e., some partial $\frac{\partial f(x)}{\partial x_i} \neq 0$.*

Definition 1.0.9. A subset X of \mathbb{R}^n is manifold if it is locally diffeomorphic to \mathbb{R}^k , that is, every point in X has a neighbourhood diffeomorphic to \mathbb{R}^k .

The nice thing about this definition is that our manifolds are subsets of \mathbb{R}^n which inherit the smooth structure of \mathbb{R}^n , so we do not have to think too abstractly about what manifolds are. We shall prove a theorem of Whitney's that says that all manifolds (in the sense of the first definition) can be imbedded in some \mathbb{R}^n , which means that the two definitions are equivalent.

Example 1.0.15. We want to show that $S^n \subset \mathbb{R}^{n+1}$ is a manifold. One way to do this is to construct charts and then show that the transition functions are smooth. An easier way would be to use the previous fact. Consider the function $f: \mathbb{R}^{n+1} \rightarrow \mathbb{R}$ given by $f(x_1, x_2, \dots, x_{n+1}) = x_1^2 + x_2^2 + \dots + x_{n+1}^2 - 1$. Now $S^n = f^{-1}(0)$ and the partial derivatives of f are given by $\frac{\partial f}{\partial x_i} = 2x_i$. Now at least one of these partials is non-zero on S^n . Hence S^n is a manifold.

Example 1.0.16. Let S^1 be the circle of radius 1 in the yz plane with its center at the point $(0, a, 0)$, where $a > 1$. Now rotate the circle about the z axis.

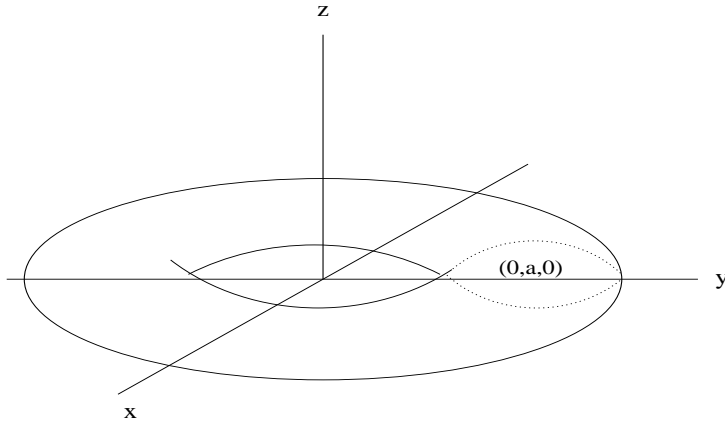

Therefore points on this surface of revolution satisfy the equation

$$z^2 = 1 - (\sqrt{x^2 + y^2} - a)^2.$$

Thus, the surface of revolution is the inverse image of 0 under the function

$$f(x, y, z) = z^2 + (\sqrt{x^2 + y^2} - a)^2 - 1.$$

This function is differentiable provided $x, y \neq 0$, and since

$$\begin{aligned} \frac{\partial f}{\partial x} &= \frac{2x(\sqrt{x^2 + y^2} - a)}{\sqrt{x^2 + y^2}}, \\ \frac{\partial f}{\partial y} &= \frac{2y(\sqrt{x^2 + y^2} - a)}{\sqrt{x^2 + y^2}}, \\ \frac{\partial f}{\partial z} &= 2z, \end{aligned}$$

0 is a regular value of f . It follows that the surface of revolution is a manifold.

Example 1.0.17. The set of $n \times n$ matrices, $M_{n \times n}$, can be naturally identified with \mathbb{R}^{n^2} . Now define $f: M_{n \times n} \rightarrow \mathbb{R}$ by $f(M) = \det M$. The function f is a smooth function (this follows from one of the exercises at the end of the section) and $f^{-1}(0)$ is a closed set. Therefore $Gl_n(\mathbb{R}) := \{M \in M_{n \times n} : \det M \neq 0\}$ is an open set of \mathbb{R}^{n^2} , thus a manifold.

Example 1.0.18. We want to show that $Sl_n(\mathbb{R}) := \{M \in M_{n \times n} : \det(M) = 1\}$ is a manifold. To do this, consider the function $f: M_{n \times n} \rightarrow \mathbb{R}$ given by $f(M) = \det M - 1$. Now $Sl_n(\mathbb{R}) = f^{-1}(0)$, so all we have to do is show

$df_x: \mathbb{R}^{n^2} \rightarrow \mathbb{R}$ is nonzero for all $x \in SL_n(\mathbb{R})$. By definition

$$\begin{aligned} \frac{\partial(\det(M))}{\partial x_{11}} &= \lim_{h \rightarrow 0} \frac{\det \begin{bmatrix} x_{11} + h & x_{12} & \dots & x_{1n} \\ x_{21} & x_{22} & \dots & x_{2n} \\ \vdots & \vdots & \ddots & \vdots \\ x_{n1} & x_{n2} & \dots & x_{nn} \end{bmatrix} - \det \begin{bmatrix} x_{11} & \dots & x_{1n} \\ \vdots & \ddots & \vdots \\ x_{n1} & \dots & x_{nn} \end{bmatrix}}{h} \\ &= \lim_{h \rightarrow 0} \frac{\det \begin{bmatrix} h & x_{12} & \dots & x_{1n} \\ 0 & \vdots & \ddots & \vdots \\ \vdots & x_{n2} & \dots & x_{nn} \end{bmatrix}}{h} \\ &= \det M_{11}. \end{aligned}$$

If all $\frac{\partial(\det(M))}{\partial x_{ij}} = 0$, then $\det M_{ij} = 0$. Hence the determinant of M is zero and M is not an element of $SL_n(\mathbb{R})$.

Exercises

1. Show that every open interval is homeomorphic to \mathbb{R} . Hint: First show that the open interval $(-\frac{\pi}{2}, \frac{\pi}{2})$ is homeomorphic to \mathbb{R} .
2. Show that \mathbb{R}^n is second countable.
3. Prove the following: The antipodal map $a: S^n \rightarrow S^n$ given by

$$a(x_0, x_1, \dots, x_n) = (-x_0, -x_1, \dots, -x_n)$$

is a diffeomorphism.

4. Show that every topological manifold is locally compact and locally connected.
5. Show that the map $f: S^n \rightarrow \mathbb{R}$ given by $f(x_1, \dots, x_{n+1}) = x_{n+1}$ is smooth.
6. Show that the map $f: \mathbb{R} \rightarrow S^1$ given by $t \rightarrow e^{it}$ is smooth.
7. Show that the map $f: GL_n(\mathbb{R}) \rightarrow GL_n(\mathbb{R})$ given by $A \rightarrow A^{-1}$ is smooth.

8. The manifold S^1 can be thought of as the complex numbers with norm 1. Show that the map $f: S^1 \rightarrow S^1$ given by $z \rightarrow z^n$ is smooth.
9. Show that the determinant map $\det: M_{n \times n} \rightarrow \mathbb{R}$ is smooth.
10. Show that $Gl_n(\mathbb{C})$ is a manifold.
11. The *diagonal* in $X \times X$ is defined to be

$$\Delta := \{(x, x) \in X \times X : x \in X\}.$$

Show that X is diffeomorphic to the diagonal.

12. The *graph* of a map $f: X \rightarrow Y$ is defined to be

$$\text{graph}(f) := \{(x, f(x)) \in X \times Y : x \in X\}.$$

Show that the map $F: X \rightarrow \text{graph}(f)$ given by $x \rightarrow (x, f(x))$ is a diffeomorphism.

13. Show that the projection map $f: X \times Y \rightarrow X$ given by $f(x, y) = x$ is smooth.
14. Show that the surface of revolution in example 16 is diffeomorphic to $T^2 = S^1 \times S^1$.
15. $PSl_2(\mathbb{R})$ is defined to be $Sl_2(\mathbb{R})/\pm I$. Show that $PSl_2(\mathbb{R})$ is diffeomorphic to $S^1 \times \mathbb{R}^2$.

2 Tangent Spaces

Let $M \subset \mathbb{R}^N$ be a k -dimensional manifold. We wish to define $T_x M$, which is the tangent space to M at x .

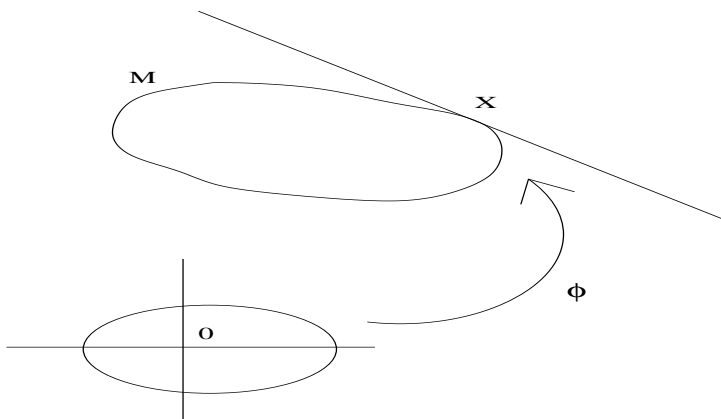

Choose a local parametrisation $\phi: U \rightarrow \phi(U) \subset M$ about x . We then have the following definition:

Definition 2.0.10. The tangent space at x is defined to be

$$T_x M := \text{Im}[d\phi_0: \mathbb{R}^k \rightarrow \mathbb{R}^N].$$

This is a k -dimensional linear subspace, since $d\phi_0$ is injective

We have to check that this definition is well-defined. That is, if we have a different local parametrisation, then the tangent space defined by this local parametrisation should be the same.

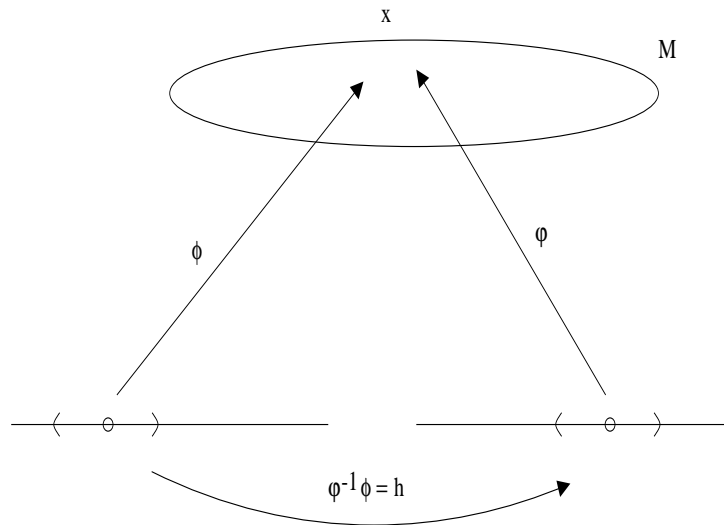

Now $d\phi_0 = d\varphi_0 \circ dh_0$, by the chain rule. Hence $\text{Im}(d\phi_0) \subseteq \text{Im}(d\varphi_0)$. Similarly, we get inclusion the other way.

Example 2.0.19. Let x be the point $(0, 0, \dots, 0, 1) \in S^n$. We have a local parametrisation $\phi: B(1) \rightarrow \mathbb{R}^{n+1}$ around x given by

$$\phi(x_0, x_1, \dots, x_{n-1}) = \left(x_0, x_1, \dots, \sqrt{1 - \sum_{i=0}^{n-1} x_i^2} \right).$$

Now $d\phi_0$ is given by the matrix

$$\begin{pmatrix} I & \\ 0 & \dots & 0 \end{pmatrix}.$$

Hence $\text{Im}[d\phi_0: \mathbb{R}^n \rightarrow \mathbb{R}^{n+1}]$ is $\mathbb{R}^n \times \{0\}$, which is the tangent space at x .

2.1 Differentiation

Let $f: X \rightarrow Y$ be a smooth map, with $y = f(x)$. We want to define a linear map $df_x: T_x(X) \rightarrow T_{f(x)}Y$.

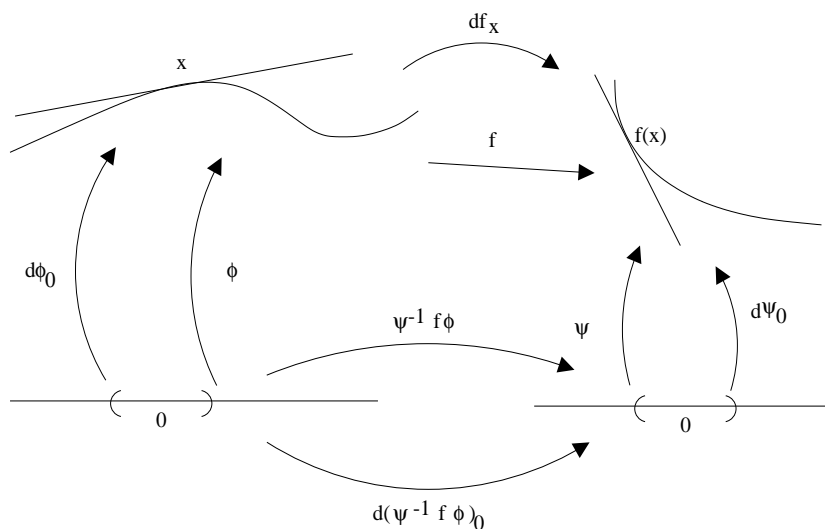

Define $df_x = d\psi_0 \circ d(\psi^{-1} f \phi)_0 \circ (d\phi_0)^{-1}$.

$$\begin{array}{ccc} T_x(X) & \xrightarrow{df_x} & T_y(Y) \\ \uparrow d\phi_0 & & \uparrow d\psi_0 \\ \mathbb{R}^k & \xrightarrow{d(\psi^{-1} f \phi)_0} & \mathbb{R}^l \end{array}$$

We define it this way so the diagram above commutes.

We have to now check that this definition is independent of ϕ .

Definition using ϕ_2 :

$$df_x = d\phi_0 \circ d(\phi^{-1} f \phi_2)_0 \circ d(\phi_2)_0^{-1}.$$

Definition using ϕ_1 :

$$\begin{aligned} df_x &= d\phi_0 \circ d(\phi^{-1} f \phi_1)_0 \circ d(\phi_1)_0^{-1} \\ &= d\phi_0 \circ d(\phi^{-1} f \phi_2)_0 \circ d(\phi_2^{-1} \phi_1)_0 \circ (d\phi_1)_0^{-1} \\ &= d\phi_0 \circ d(\phi^{-1} f \phi_2)_0 \circ d(\phi_2)_0^{-1}. \end{aligned}$$

Hence the definition is independent of our choice of parametrisation.

Let $f: X \rightarrow Y$ and $g: Y \rightarrow Z$ both be smooth maps between smooth manifolds. Then we have the following chain rule:

$$\begin{array}{ccccc}
 T_x(X) & \xrightarrow{df_x} & T_y(Y) & \xrightarrow{dg_y} & T_z(Z) \\
 & \searrow & & \nearrow & \\
 & & d(gf)_x & &
 \end{array}$$

where $f(x) = y$ and $g(y) = z$.

Here are two more equivalent definitions of $T_x(X)$.

2.2 Curve Definition

Consider the smooth curves

$$\begin{aligned}
 \alpha: \mathbb{R} &\rightarrow M \\
 \alpha(0) &= x.
 \end{aligned}$$

α_1 and α_2 have the same velocity if for some (equivalently any) chart $\varphi: U \rightarrow \mathbb{R}^k$ around x the curves $\varphi \circ \alpha_1$ and $\varphi \circ \alpha_2$ have the same velocity at 0, i.e., $d(\varphi(\alpha_1))_0 = d(\varphi(\alpha_2))_0$.

Example 2.2.1. The two curves $\alpha_1: \mathbb{R} \rightarrow \mathbb{R}^2$ and $\alpha_2: \mathbb{R} \rightarrow \mathbb{R}^2$ given by $\alpha_1(t) = (t, t^2)$ and $\alpha_2(t) = (t, 0)$ are equivalent, since they have the same velocity at zero.

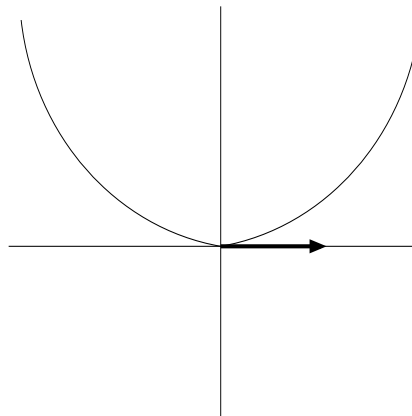

Example 2.2.2. The two curves $\alpha_1: \mathbb{R} \rightarrow S^1$ and $\alpha_2: \mathbb{R} \rightarrow S^1$ given by $\alpha_1(t) = (\cos t, \sin t)$ and $\alpha_2(t) = (\cos 2t, \sin 2t)$ are not equivalent.

Definition 2.2.1. A tangent vector at $x \in M$ is an equivalence class of curves, where the equivalence relation is $\alpha_1 \sim \alpha_2$ if, and only if, α_1 and α_2 have the same velocity at 0. The set of all tangent vectors is called the *tangent space* to M at x , which we denote $T_x M$.

Fix a chart $\varphi: U \rightarrow \mathbb{R}^k$ with $x \in U$. Then we have a well-defined map $T_x M \rightarrow \mathbb{R}^k$ given by

$$[\alpha] \rightarrow d(\varphi(\alpha))_0$$

if $\alpha(0) = x$. We have a map $\mathbb{R}^k \rightarrow T_x M$ given by

$$v \rightarrow [\varphi^{-1}(\varphi(x) + tv)]$$

Thus $T_x M$ as a set is bijective with \mathbb{R}^k , and hence inherits a vector space structure. This is independent of the choice of charts for if $\phi: V \rightarrow \mathbb{R}^k$ is another chart with $x \in V$, then

$$d(\varphi(\alpha))_0 = d(\varphi \circ \phi^{-1} \circ \phi(\alpha))_0 = d(\varphi \circ \phi^{-1})d(\phi(\alpha))_0.$$

Thus the two identifications are related by a linear isomorphism.

Definition 2.2.2. Let $f: X \rightarrow Y$ be a smooth map. We define the derivative at x to be the linear map

$$df_x: T_x(X) \rightarrow T_{f(x)}(Y) \quad \text{given by}$$

$$df_x([\alpha]) = [f \circ \alpha].$$

2.3 Derivations

Let X be a manifold. The set of smooth functions from X to \mathbb{R} is denoted by $C^\infty(X)$. This is a linear space, in the obvious way.

Definition 2.3.1. A *derivation at x* is a linear functional $L: C^\infty(X) \rightarrow \mathbb{R}$ such that

- (1) If $f_1, f_2 \in C^\infty$ agree in a neighbourhood of x , then $L(f_1) = L(f_2)$.
- (2) $L(fg) = L(f)g(x) + f(x)L(g)$ (Leibniz Rule).

Example 2.3.1. If $X = \mathbb{R}^n$ and v is a tangent vector at x , then $L = \frac{\partial}{\partial v}$ is a derivation.

Lemma 2.3.1. *Let $f: U \rightarrow \mathbb{R}$ be a smooth function, where U is an open, convex set in \mathbb{R}^k which contains the origin. Also, suppose that $f(0) = 0$. Then there exist smooth functions $g_i: U \rightarrow \mathbb{R}$ such that:*

$$(1) f(x_1, x_2, \dots, x_k) = \sum_{i=1}^k x_i g_i(x_1, x_2, \dots, x_k).$$

$$(2) g_i(0) = \frac{\partial f(0)}{\partial x_i}.$$

Proof.

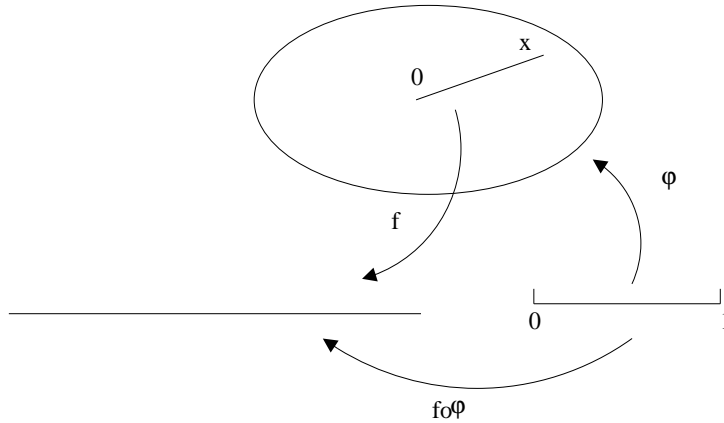

Let $x \in U$. The set U is convex, therefore the straight line segment between x and 0 lies in U . Define $\varphi: [0, 1] \rightarrow U$ by $t \rightarrow tx$ (The image of φ is just the straight line joining 0 to x). Now define g by $g(t) = f \circ \varphi(t)$. Then by the first fundamental theorem of calculus we have

$$g(1) - g(0) = \int_0^1 g'(t) dt.$$

The left hand side of the equation is just $f(x)$. Now $dg = df \circ d\varphi_0$ and

$$(d\varphi)_0 = \begin{pmatrix} x_1 \\ x_2 \\ \vdots \\ x_k \end{pmatrix}.$$

Also, $df = \left(\frac{\partial f}{\partial x_1}, \dots, \frac{\partial f}{\partial x_k} \right)$. Hence

$$g'(t) = \sum_{i=1}^k x_i \frac{\partial f}{\partial x_i}.$$

Replacing this in the original equation we obtain the following:

$$\begin{aligned} f(x) &= \int_0^1 \sum_{i=1}^k x_i \frac{\partial f}{\partial x_i}(tx) dt \\ &= \sum_{i=1}^k x_i \int_0^1 \frac{\partial f}{\partial x_i}(tx) dt. \end{aligned}$$

If we define $g_i(x)$ to be $\int_0^1 \frac{\partial f}{\partial x_i}(tx) dt$, then the lemma is proved. \square

Theorem 2.3.1. *Every derivation on $(\mathbb{R}^k, 0)$ is a linear combination of*

$$\left\{ \frac{\partial}{\partial x_i} \Big|_0 \right\}_{1 \leq i \leq k}.$$

Proof. Let L be any derivation at x . Now $L(1) = L(1 \cdot 1) = L(1) \cdot 1 + 1 \cdot L(1)$. This implies that $L(1) = 0$. Let f be any smooth function. Then $L(f) = L(f - f(0))$. So we can assume that $f(0) = 0$.

$$\begin{aligned} L(f) &= L\left(\sum_{i=1}^k x_i g_i\right) \\ &= \sum_{i=1}^k L(x_i g_i) \\ &= \sum_{i=1}^k [L(x_i)g_i(0) + x_i|_0 L(g_i)] \\ &= \sum_{i=1}^k L(x_i)g_i(0) \\ &= \sum_{i=1}^k L(x_i) \frac{\partial f}{\partial x_i}(0). \end{aligned}$$

\square

An aside on Germs.

Let $x \in X$. We say $f_1, f_2 \in C^\infty(X)$ are equivalent if there exists a neighbourhood U , which contains x , such that $f_1|_U = f_2|_U$. A *germ* of

smooth functions at x is an equivalence class. Derivations are really linear maps on the space of germs.

$$T_x(X) = \{\text{linear space of all derivations at } x\}$$

Exercises

1. Prove that two manifolds M and N of dimension m and n cannot be diffeomorphic if $m \neq n$.
2. Show that if $X \subset Y \subseteq \mathbb{R}^n$ are manifolds and $i: X \rightarrow Y$ is inclusion, then for each $x \in X$, $di_x: T_x X \rightarrow T_x Y$ is also an inclusion.
3. Let X and Y be manifolds. Prove the following:

(a) $T_{(x,y)}(X \times Y) = T_x X \times T_y Y$.

(b) Let $f: X \times Y \rightarrow X$ be the projection. Then

$$df_{(x,y)}: T_{(x,y)}(X \times Y) \rightarrow T_x X$$

is also a projection.

(c) Let $y \in Y$, and let $f: X \rightarrow X \times Y$ be defined by $f(x) = (x, y)$. Then $df_x(v) = (v, 0)$.

(d) Let $f: X \rightarrow Y$ and $g: X' \rightarrow Y'$ be smooth maps, and define $f \times g: X \times X' \rightarrow Y \times Y'$ by $f \times g(x, y) = (f(x), g(y))$. Show that $d(f \times g)_{(x,y)} = df_x \times dg_y$.

Theorem 2.3.2 (Inverse Function Theorem (Calculus version)). *Let U be an open subset of \mathbb{R}^n , and let $f: U \rightarrow \mathbb{R}^n$ be a smooth function. If $df_x: \mathbb{R}^n \rightarrow \mathbb{R}^n$ is invertible, then there exists a neighbourhood V , containing x , such that $f: V \rightarrow f(V)$ is a diffeomorphism.*

Definition 2.3.2. Let $f: X \rightarrow Y$ be a smooth function. We say f is a *local diffeomorphism* at $x \in X$ if $df_x: T_x(X) \rightarrow T_{f(x)}(Y)$ is an isomorphism.

Theorem 2.3.3 (Inverse Function Theorem). *Let $f: X \rightarrow Y$ be a local diffeomorphism at $x \in X$. Then there exists a neighbourhood U , containing x , such that $f: U \rightarrow f(U)$ is a diffeomorphism.*

Proof. Just use the calculus version. □

Example 2.3.2. The covering map $\mathbb{R} \rightarrow S^1$ given by $t \rightarrow e^{2\pi it}$ is a local diffeomorphism, but not a global diffeomorphism.

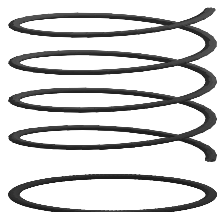

2.4 Immersions

Definition 2.4.1. We say $f: X \rightarrow Y$ is an *immersion* at x if $df_x: T_x(X) \rightarrow T_{f(x)}(Y)$ is injective.

Example 2.4.1. Let U be an open set in \mathbb{R}^n , and let $i: U \rightarrow \mathbb{R}^n$ be the inclusion map. Then i is an immersion.

Example 2.4.2. The map $f: \mathbb{R} \rightarrow \mathbb{R}^3$ given by $f(t) = (\cos t, \sin t, t)$ is an immersion. The image is a *helix* lying on the unit cylinder.

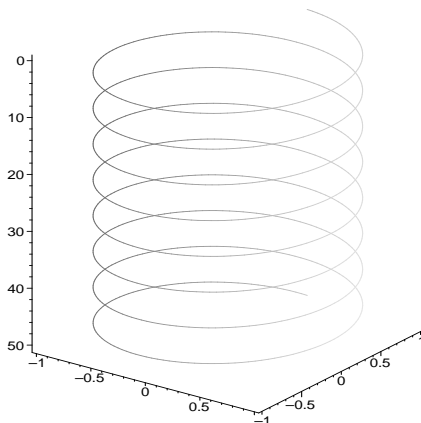

Example 2.4.3. The map $f: \mathbb{R} \rightarrow \mathbb{R}^2$ given by $f(t) = (\cos t, \sin t)$ is an immersion. The image is the unit circle.

Example 2.4.4. The map $f: \mathbb{R} \rightarrow \mathbb{R}^2$ given by $f(t) = (2 \cos(t - \frac{1}{2}\pi), \sin 2(t - \frac{1}{2}\pi))$ is an immersion. Its image is shown below.

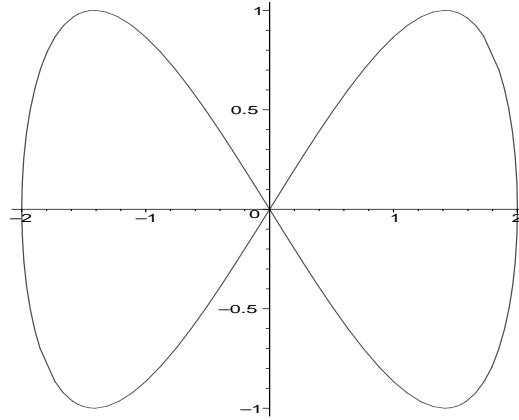

Example 2.4.5. Let $n \geq k$, the map $i: \mathbb{R}^k \rightarrow \mathbb{R}^n$ given by $i(x_1, \dots, x_k) = (x_1, \dots, x_k, 0, \dots, 0)$ is called the standard immersion.

Theorem 2.4.1 (Local Immersion Theorem). Let $f: X \rightarrow Y$ be an immersion at $x \in X$ and $\phi: U \rightarrow X$ a local parametrisation with $\phi(0) = x$. Then there is a local parametrisation $\psi: V \rightarrow Y$, with $\psi(0) = f(x)$, such that after possibly shrinking U and V , $\psi^{-1} \circ f \circ \phi$ is the restriction of the inclusion map.

Proof. Start by choosing some local parametrisation $\psi_1: V_1 \rightarrow Y$, with $\psi_1(0) = y$.

$$\begin{array}{ccc}
 X^k & \xrightarrow{f} & Y^l \\
 \uparrow \phi & & \uparrow \psi_1 \\
 U & \xrightarrow{g_1 = \psi_1^{-1} \circ f \circ \phi} & V_1
 \end{array}$$

Now the map $d(g_1)_0: \mathbb{R}^k \rightarrow \mathbb{R}^l$ is injective (because df_x is injective). Now let $L: \mathbb{R}^n \rightarrow \mathbb{R}^n$ be a linear isomorphism such that $L \circ (dg_1)_0 = i$.

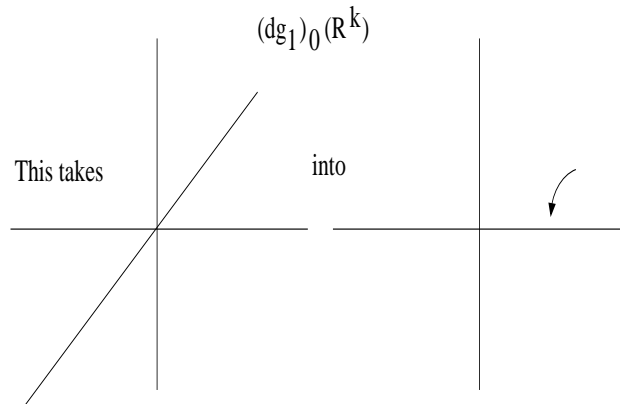

$$\begin{array}{ccccc}
 X^k & \xrightarrow{f} & Y^l & & \\
 \uparrow \phi & & \uparrow \psi_1 & \swarrow \psi_2 & \\
 U & \xrightarrow{g_1} & V_1 & \xrightarrow{L} & L(V_1) \\
 & \searrow & \text{---} & \text{---} & \text{---} \\
 & & g_2 = L \circ g_1 & &
 \end{array}$$

Now define $G: U \times \mathbb{R}^{l-k} \rightarrow \mathbb{R}^l$ by $G(a, z) = g_2(a) + (0, z)$.

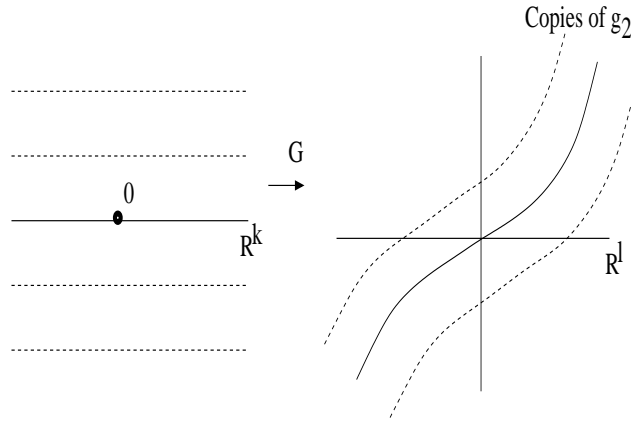

Then

$$dG_0 = \begin{pmatrix} I & \\ & I \end{pmatrix}.$$

This implies that G is a local diffeomorphism. Note: If we take the standard inclusion and G we get $g_2 = G \circ i$.

$$\begin{array}{ccccccc}
 X^k & \xrightarrow{f} & Y^l & & & & \\
 \uparrow \phi & & \uparrow \psi_1 & \swarrow \psi_2 & \xrightarrow{\psi_2 \circ G = \psi} & & \\
 U & \xrightarrow{g_1} & V_1 & \xrightarrow{L} & L(V_1) & \xleftarrow{G} & V \\
 & \searrow & \text{---} & \text{---} & \text{---} & \text{---} & \\
 & & i & & & &
 \end{array}$$

□

Corollary 2.4.1. *If $f: X \rightarrow Y$ is an immersion at x , then f is an immersion for every point in some neighbourhood of x .*

Definition 2.4.2. A k -dimensional submanifold of a manifold $X \subseteq \mathbb{R}^n$ is a subset $Y \subseteq X$, which is a k -dimensional manifold, when viewed as a subset of \mathbb{R}^n .

Definition 2.4.3. A k -dimensional submanifold Y of a manifold X is a subset $Y \subset X$ such that for all $y \in Y$ there exists a chart (in the atlas of X) $\phi: U \rightarrow \phi(U) \subset \mathbb{R}^n$, with $y \in U$, such that $U \cap Y = \mathbb{R}^k \cap \phi(U)$ (so $\phi: U \cap Y \rightarrow \phi(U) \cap \mathbb{R}^k$ is a chart for Y).

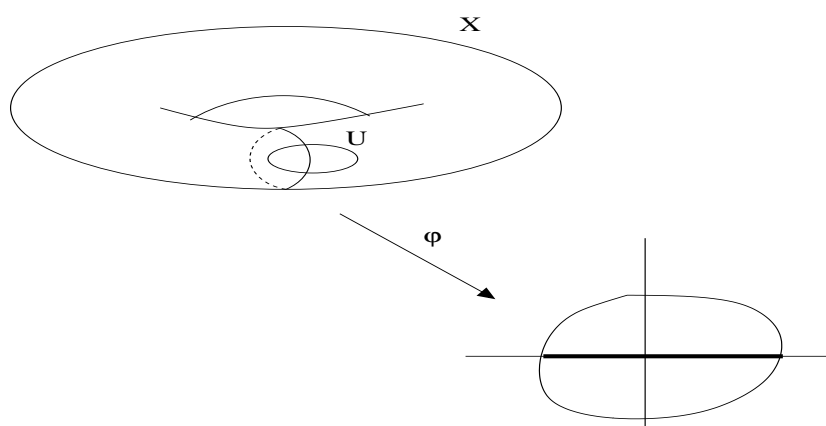

Example 2.4.6. A point in \mathbb{R}^n is a submanifold of \mathbb{R}^n .

Example 2.4.7. S^1 is a submanifold of \mathbb{R}^2 .

Example 2.4.8. The torus $T^2 = S^1 \times S^1$ is a submanifold of \mathbb{R}^4 .

Proposition 2.4.1. *If $Y \subset X \subset \mathbb{R}^n$ is a submanifold in the sense of the first definition, then it is a submanifold in the sense of the second definition.*

Proof. Let y be a point in Y . Then according to the first definition there exists a local parametrisation, $\phi: W \rightarrow Y$, with $y \in W$. Since ϕ is a local parametrisation, $i \circ \phi: W \rightarrow X$ is an immersion. By the local immersion theorem there exists a local parametrisation $\psi: V \rightarrow X$ around $i(y)$ such that $\varphi = \psi^{-1} \circ \phi: W \rightarrow V$ is the standard inclusion. Now $\varphi^{-1}: \varphi(V) \rightarrow V$ almost works.

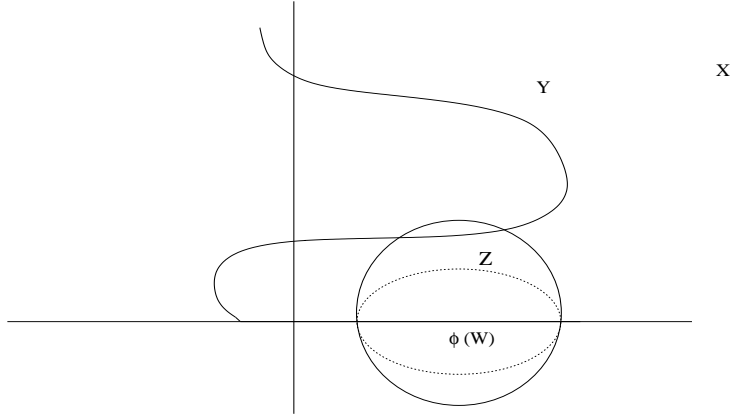

The remaining problem is that $\varphi(V) \cap Y$ might be larger than $\phi(W)$. But $\phi(W)$ is open in Y , so by definition there exists an open set $Z \subset X$ such that $Z \cap Y = \phi(W)$. Now replace $\varphi(V)$ by $\varphi(V) \cap Z$ and replace V by $\varphi^{-1}(\varphi(V) \cap Z)$. \square

Proposition 2.4.2. *Let X and Y be manifolds, with X compact. If $f: X \rightarrow Y$ is an injective immersion, then $f(X)$ is a submanifold of Y . Moreover, $f: X \rightarrow f(X)$ is a diffeomorphism.*

Proof. We shall first show that if U is open in X , then $f(U)$ is open in Y . To do this, we argue that $f(X) - f(U)$ is closed in Y . Now $f(X) - f(U)$ is compact, since $X - U$ is compact and $f(X - U) = f(X) - f(U)$. Hence $f(X) - f(U)$ is closed. This implies $f: X \rightarrow f(X)$ is a homeomorphism. By the local immersion theorem, $f^{-1}: f(X) \rightarrow X$ is smooth. \square

Definition 2.4.4. A map $f: X \rightarrow Y$ is *proper* if the preimage of every compact set is compact.

If X is a topological manifold, a sequence $\{x_n\}$ is said to *escape to infinity* if it has no convergent subsequence. The following proposition makes it somewhat easier to visualize what a proper map does.

Proposition 2.4.3. *Let $f: X \rightarrow Y$ be a continuous map between topological manifolds. Then f is proper if, and only if, for every sequence $\{x_n\}$ in X that escapes to infinity, $\{f(x_n)\}$ escapes to infinity in Y .*

Definition 2.4.5. Let $f: X \rightarrow Y$ be a smooth map between two manifolds. We say f is an *embedding* if f is proper and a one-to-one immersion.

Remark: Some books will use the term embedding instead of imbedding

Example 2.4.9. Let n, m be integers with $(n, m) = 1$. Then the map $f: S^1 \rightarrow T^2$ given by $f(z) = (z^n, z^m)$ is an imbedding. The image is knotted and we call the image a *torus knot* of type (n, m) .

Example 2.4.10. Let $g: \mathbb{R} \rightarrow \mathbb{R}$ be the function $g(t) = \pi + 2 \arctan t$. Now let $f: \mathbb{R} \rightarrow \mathbb{R}^2$ be the function $f(t) = (2 \cos(g(t) - \frac{\pi}{2}), \sin 2(g(t) - \frac{\pi}{2}))$. Then f is an one-to-one immersion but not an imbedding.

Example 2.4.11. Let L be the line $y = \alpha x$, where α is an irrational number. Now consider the map $g: \mathbb{R} \rightarrow \mathbb{R}^2$ given by $g(t) = (t, \alpha t)$. The image of g is thus L . Now consider the map $\pi \circ g: \mathbb{R} \rightarrow T^2$, where $\pi: \mathbb{R}^2 \rightarrow T^2$ is the quotient map $\mathbb{R}^2 \rightarrow \mathbb{R}^2/\mathbb{Z}^2$. Part of the image of $\pi \circ g$ is shown below.

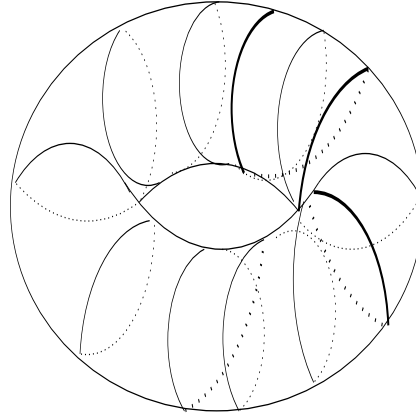

This map is injective, for if $\pi \circ g(t_1) = \pi \circ g(t_2)$, then $t_1 - t_2$ and $\alpha(t_1 - t_2)$ are both integers, which is impossible, unless $t_1 = t_2$. The map g is a diffeomorphism and π is a local diffeomorphism, hence $\pi \circ g$ is an immersion. We shall now show that the image of $\pi \circ g$ is dense in T^2 . Consider the family of lines $\{y = \alpha x + (n - m\alpha): n, m \in \mathbb{Z}\}$.

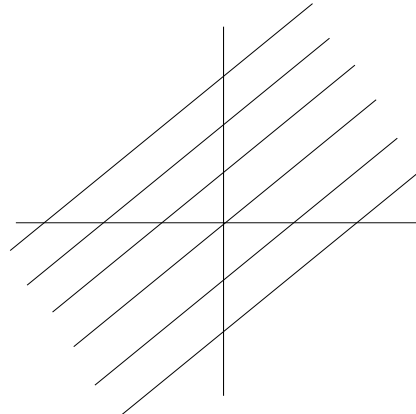

Each of these lines has the same image in T^2 under π . So if we can show that these lines are dense in \mathbb{R}^2 , then we are done, since π is a continuous map which is onto, and therefore maps a dense set to a dense set. For this we need to show that the y intercepts are dense. This follows from exercise 1 below. The image of $\pi \circ g$ is dense, hence $\pi \circ g$ cannot be a proper map. Therefore $\pi \circ g$ is not an imbedding.

Exercises

1. Let H be a discrete subgroup of \mathbb{R} under addition. Show that H is isomorphic to \mathbb{Z} . Show that the subgroup generated by 1 and m , where m is an irrational number, is isomorphic to $\mathbb{Z} \oplus \mathbb{Z}$. Conclude that the subgroup generated by 1 and m is dense. Hence the image of $\pi \circ g$ is dense in T^2 .
2. Define a map $F: S^2 \rightarrow \mathbb{R}^4$ by

$$F(x, y, z) = (x^2 - y^2, xy, xz, yz).$$

Show that F induces a map from $\mathbb{R}P^2$ to \mathbb{R}^4 , and that this map is an imbedding.

3. Let $f: X \rightarrow Y$ be a smooth map, which is one-to-one on a compact submanifold Z . Also, suppose that $df_x: T_x X \rightarrow T_{f(x)} Y$ is an isomorphism for all $x \in Z$. Then f maps a neighbourhood of Z diffeomorphically onto a neighbourhood of $f(Z)$ in Y .
4. Prove that the map in example 32 is actually an imbedding.
5. Let $f: X \rightarrow Y$ be an imbedding. Show that $f: X \rightarrow f(X)$ is a diffeomorphism.
6. We showed in Chapter 1 that the cone can be given a smooth structure. Given an explicit imbedding of the cone into \mathbb{R}^2 .

2.5 Submersions

Definition 2.5.1. Let $f: X \rightarrow Y$ be a smooth map between two manifolds. We say f is a *submersion* at $x \in X$, if the map $df_x: T_x(X) \rightarrow T_{f(x)}(Y)$ is surjective.

Example 2.5.1. The map $p: S^1 \times S^1 \rightarrow S^1$ given by $p(x, y) = x$ is a submersion.

Example 2.5.2. The standard submersion is the map $\pi: \mathbb{R}^{k+l} \longrightarrow \mathbb{R}^l$ given by $(x_1, \dots, x_{k+l}) \rightarrow (x_1, \dots, x_l)$

Theorem 2.5.1 (Local Submersion Theorem). *Let $f: X \longrightarrow Y$ be a submersion at $x \in X$, and let $\varphi: V \longrightarrow Y$ be a local parametrisation with $\varphi(0) = f(x)$. Then there exists a local parametrisation $\phi: U \longrightarrow X$, with $\phi(0) = x$, such that after possibly shrinking U and V , the map $\varphi^{-1}f\phi$ is the standard submersion.*

Proof. First pick any local parametrisation $\phi: U \longrightarrow X$

$$\begin{array}{ccc} X^k & \xrightarrow{f} & Y^l \\ \uparrow \phi & & \uparrow \varphi \\ U & \xrightarrow{g=\varphi^{-1}f\phi} & V \end{array}$$

By a linear change of coordinates, if necessary, we can assume that dg_0 is the projection map. Now define $G: U \longrightarrow \mathbb{R}^k \times \mathbb{R}^l$ by

$$G(a) = (g(a), a_{k+1}, \dots, a_{k+l}).$$

Then

$$dG_0 = \begin{pmatrix} I & \\ & I \end{pmatrix}.$$

Hence G is a local diffeomorphism. So by possibly shrinking U and V we have the result. \square

Corollary 2.5.1. *If $f: X \longrightarrow Y$ is a submersion at $x \in X$, then f is a submersion for every point in a small neighbourhood of x .*

Definition 2.5.2. Let $f: X \longrightarrow Y$ be a smooth map. Then $y \in Y$ is a *regular value* of f , if for all $x \in X$ such that $f(x) = y$, f is a submersion at x .

Theorem 2.5.2. *If $y \in Y$ is a regular value of f , then $f^{-1}(y) \subset X$ is a submanifold of X and $\text{codim}_X(f^{-1}(y)) = \text{codim}_Y(y)$.*

Proof. Since f is a submersion at $x \in f^{-1}(y)$, there exists a local parametrisation where f looks like.

$$\begin{array}{ccc} X & \xrightarrow{f} & Y \\ \uparrow \phi & & \uparrow \psi_1 \\ U & \xrightarrow{\pi} & V \end{array}$$

Hence $\phi: U \cap \mathbb{R}^l \longrightarrow f^{-1}(y)$ is a local parametrisation at $x \in f^{-1}(y)$. \square

Proposition 2.5.1. *Let $f: X \longrightarrow Y$ be a smooth map, and let $y \in Y$ be a regular value. If $x \in f^{-1}(y)$, then*

$$T_x(f^{-1}(y)) = \ker[df_x: T_x(X) \longrightarrow T_{f(x)}(Y)].$$

Proof. They have the same dimension and $T_x(f^{-1}(y)) \subseteq \ker[df_x]: f|_{f^{-1}(y)}$ is constant so has derivative zero. Hence they are equal. \square

Suppose $M = f^{-1}(0)$, where $f: \mathbb{R}^n \longrightarrow \mathbb{R}$ is a smooth function. Then the previous proposition allows us to work out the tangent space at each point $x \in M$.

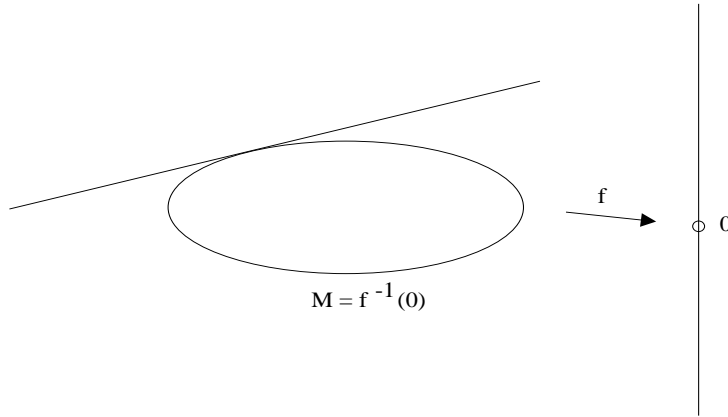

The previous proposition tells us that $T_x(M) = \ker[df_x: \mathbb{R}^n \longrightarrow \mathbb{R}]$.

Example 2.5.3. Consider the point $a = (a_0, a_1, \dots, a_n) \in S^n \subset \mathbb{R}^{n+1}$. Define $f: \mathbb{R}^{n+1} \longrightarrow \mathbb{R}$ by

$$f(x_0, x_1, \dots, x_n) = \left(\sum_{i=0}^n x_i^2 \right) - 1.$$

Zero is a regular value of f and $S^n = f^{-1}(0)$. Therefore $T_a(S^n) = \ker[df_a]$. Now $df_a = [2a_0, 2a_1, \dots, 2a_n]$, which implies

$$T_a(S^n) = \{(x_0, x_1, \dots, x_n) \in \mathbb{R}^{n+1} : \sum a_i x_i = 0\} = a^\perp.$$

Example 2.5.4. Let $O(n) = \{A \in M_{n \times n} : AA^T = I\}$ (the orthogonal matrices). Alternatively, $O(n)$ is just the group of rotations of \mathbb{R}^n . In order to show $O(n)$ is a manifold we define a map between two smooth manifolds such that $O(n)$ is the preimage of a regular value. Define $f: M_{n \times n} \rightarrow S_{n \times n}$ ($S_{n \times n}$ is the set of symmetric matrices) to be $f(A) = AA^T$. Now f is a smooth map: If you write out this matrix multiplication you will get a matrix with entries that are polynomials in the variables of your original matrix. Also, $O(n) = f^{-1}(I)$. Let $A \in O(n)$. Then $df_A: M_{n \times n} \rightarrow S_{n \times n}$ is by definition

$$\begin{aligned} df_A(B) &= \lim_{s \rightarrow 0} \frac{f(A + sB) - f(A)}{s} \\ &= \lim_{s \rightarrow 0} \frac{(A + sB)(A + sB)^T - AA^T}{s} \\ &= BA^T + AB^T. \end{aligned}$$

We want to show this map is surjective. Let $C \in S_{n \times n}$. Now in order to show surjectivity we have to find a $B \in M_{n \times n}$ such that $BA^T + AB^T = C$. To do this we have to solve the equation $BA^T = \frac{1}{2}C$. The solution to this equation is $B = \frac{1}{2}CA$. This shows that I is a regular value. Hence $O(n)$ is a smooth manifold. What is $T_I(O(n))$? Since $df_I(B) = B + B^T$ and $O(n) = f^{-1}(I)$ we have $T_I(O(n)) = \ker(df_I) = \{B \in M_{n \times n} : B = -B^T\}$ (the anti-symmetric matrices).

Exercises

1. Show that $X := \{(z_1, \dots, z_n) \in \mathbb{C}^n : z_1^2 + \dots + z_n^2 = 1\}$ is a manifold.
2. Show that $SO(n) := \{A \in O(n) : \det A = 1\}$ is a manifold. Also, show that $SO(3)$ is diffeomorphic to $\mathbb{R}P^3$.
3. Show that $O(n)$ is compact and find its dimension.
4. Show that $U(n) := \{A \in Gl_n(\mathbb{C}) : AA^* = I\}$ is a manifold. Here A^* means take the transpose of the matrix and then take the complex conjugate of all the entries.
5. Find an imbedding of T^n in $U(n)$.
6. Compute the tangent space to the hyperboloid

$$H := \{(x, y, z, t) \in \mathbb{R}^4 : x^2 + y^2 + z^2 - t^2 = -1\}$$

at the point (x, y, z, t) .

7. Let $O(k, n - k) = \{A \in Gl_n(\mathbb{R}) : A^T I_{k, n-k} A = I_{k, n-k}\}$, where $I_{k, n-k}$ is the $n \times n$ matrix with k 1's followed by $(n - k)$ -1's down the diagonal, and zeroes elsewhere. Prove that $O(k, n - k)$ is a manifold.

Example 2.5.5. In the previous chapter we showed that $Sl_n(\mathbb{R})$ was a manifold by showing that zero was the only critical value of the map $f: M_{n \times n} \rightarrow \mathbb{R}$ given by $f(M) = \det M - 1$. We can use this map to find out what $T_I(Sl_n(\mathbb{R}))$ is. Now df_I is the $1 \times n^2$ matrix $[10 \dots 010 \dots 01 \dots 01]$, where there are n zeroes in between each one. Therefore $T_I(Sl_n(\mathbb{R}))$ consists of $n \times n$ matrices with trace 0.

Is there a local diffeomorphism $S^2 \rightarrow \mathbb{R}^2$? The answer is no. As an example consider the figure below and the map which projects a point on the sphere to the point on the plane below it. This map is not a local diffeomorphism on the equator.

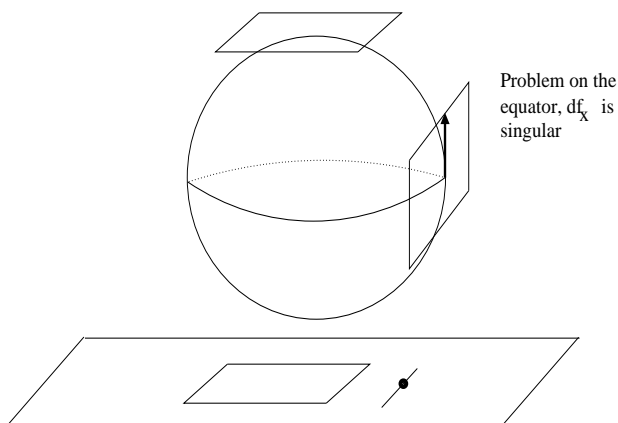

Lemma 2.5.1. *Every submersion $f: X \rightarrow Y$ is an open map.*

Proof. The projection map $\pi: \mathbb{R}^{k+l} \rightarrow \mathbb{R}^k$ is an open map. So to prove the lemma we can work in the charts, which takes us to projections, and it is proved. \square

Lemma 2.5.2. *Let X be a compact topological space, and let $f: X \rightarrow Y$ be a continuous function. Then $f(X)$ is compact.*

Using the two preceding lemmas we can conclude that there is no submersion from a non-empty compact manifold X to a connected non-compact manifold. Hence, there is no local diffeomorphism $f: S^2 \rightarrow \mathbb{R}^2$. In fact, there is no local diffeomorphism from S^n to \mathbb{R}^n .

Theorem 2.5.3 (Stack of Records Theorem). *Suppose $f: X \rightarrow Y$ is a smooth map, with X compact, $\dim(X) = \dim(Y)$ and $y \in Y$ a regular value. Then $f^{-1}(y)$ is a finite set $\{x_1, \dots, x_k\}$, and there are neighbourhoods $U_i \ni x_i$, and $V \ni y$ such that $U_i \cap U_j = \emptyset$ for $i \neq j$ and $f^{-1}(V) = \cup_{i=1}^k U_i$. Moreover, $f|_{U_i}: U_i \rightarrow V$ is a diffeomorphism.*

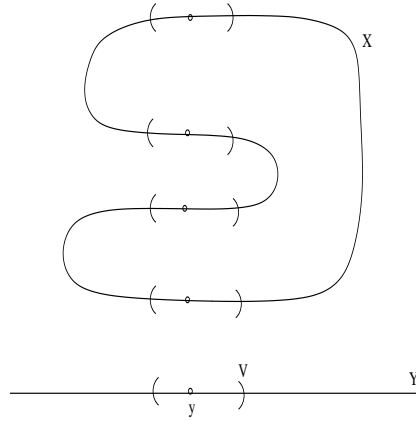

Proof. Since y is a regular value $f^{-1}(y)$ is a manifold of dimension zero. Also $f^{-1}(y)$ is compact. Thus, $f^{-1}(y)$ is finite, say $f^{-1}(y) = \{x_1, x_2, \dots, x_k\}$. Now f is a local diffeomorphism at each x_i , so by the local diffeomorphism theorem there exists neighbourhoods $U'_i \ni x_i$, $V'_i \ni y$ such that $f: U'_i \rightarrow V'_i$ is a diffeomorphism. We can shrink the U'_i 's to require that $U'_i \cap U'_j = \emptyset$ if $i \neq j$, because $f^{-1}(y)$ is finite. Let $V' = \cap_{i=1}^k V'_i$, and let $U''_i = U'_i \cap f^{-1}(V')$. It is clear that $f: U''_i \rightarrow V'$ is a diffeomorphism. Let $Z = f(X - \cup U''_i)$. The set Z is closed in Y and does not contain y . Thus the sets $V := V' - Z$ and $U_i := U''_i \cap f^{-1}(V)$ are the required sets. \square

An application of the stacks of records theorem is the fundamental theorem of algebra: Every non-constant polynomial with complex coefficients has a root in \mathbb{C} .

We shall only give an outline of the proof (which is due to Milnor).

Let $p(z) = a_n z^n + a_{n-1} z^{n-1} + \dots + a_1 z + a_0$, where $n \geq 1$ and $a_n \neq 0$. Now as $|z|$ tends to infinity $|p(z)|$ also tends to infinity. So we extend $p(z)$ to the Riemann sphere, by defining $p(\infty) = \infty$. This new map \tilde{p} is smooth on the Riemann sphere. So there are finitely many points (less than or equal n) where $\tilde{p}(z)$ fails to be a local diffeomorphism. Hence there are at most n points y_1, y_2, \dots, y_n in $\tilde{\mathbb{C}}$ which fail to be regular values. Define

$\Phi: \tilde{\mathbb{C}} - \{y_1, y_2, \dots, y_n\} \longrightarrow \{0, 1, \dots\}$ by $\Phi(y) = \text{card } \tilde{p}^{-1}(y)$. Now by the stacks of record theorem Φ is locally constant, but $\tilde{\mathbb{C}} - \{y_1, y_2, \dots, y_n\}$ is connected. Hence Φ is constant and is not zero. We deduce that $p(z) = c$ has a solution for all $c \in \mathbb{C}$.

Note: If $y \in \text{Im}(p)$, then y is a regular value. If $\Phi = 0$, then $\text{Im}(p) \subseteq \{y_1, y_2, \dots, y_n\}$, which implies p is constant.

2.6 Grassmannians

Fix integers $0 < k < n$ and by $G_k(\mathbb{R}^n)$ denote the set of all k -dimensional subspaces in \mathbb{R}^n . We shall give $G_k(\mathbb{R}^n)$ a topology so that it becomes a manifold. Manifolds of this type are called *Grassmannians*. Notice that $G_1(\mathbb{R}^{n+1})$ is just $\mathbb{R}P^n$.

Exercises

1. Let $P \in G_k(\mathbb{R}^n)$, and let $\pi_P: \mathbb{R}^n \longrightarrow \mathbb{R}^n$ be the orthogonal projection to P . Prove that the matrix M_P of π_P is symmetric, has rank k , and it satisfies $M_P^2 = M_P$.
2. If M is any symmetric $n \times n$ matrix of rank k that satisfies $M^2 = M$, then $M = M_P$ for some $P \in G_k(\mathbb{R}^n)$.

We shall thus identify $G_k(\mathbb{R}^n)$ with the set $\mathcal{M}_k(\mathbb{R}^n)$ of $n \times n$ symmetric matrices of rank k satisfying $M^2 = M$. In this way $G_k(\mathbb{R}^n)$ is realized as a subset of Euclidean space.

3. Show that it is sufficient to show that $\mathcal{M}_k(\mathbb{R}^n)$ is a manifold at one point. (Hint: Use the action of $O(n)$.)
4. Suppose

$$\begin{pmatrix} A & B \\ C & D \end{pmatrix}$$

is a block matrix with A nonsingular of size $k \times k$. Show that this matrix has rank k if, and only if, $D = CA^{-1}B$.

5. Show that the block matrix above belongs to $\mathcal{M}_k(\mathbb{R}^n)$ if, and only if,
 - (1) A is symmetric,
 - (2) $C = B^T$,

$$(3) D = CA^{-1}B,$$

$$(4) A^2 + BC = A.$$

6. Show that $\{(A, B) \in S(k) \times M_{k \times (n-k)} : A^2 + BB^T = A\}$ is a manifold at $(I, 0)$.
7. Finish the proof that $\mathcal{M}_k(\mathbb{R}^n)$ is a manifold. What is its dimension?
8. Compute the tangent space of $\mathcal{M}_k(\mathbb{R}^n)$ at

$$\begin{pmatrix} I & 0 \\ 0 & 0 \end{pmatrix}.$$

3 Transversality Part I

We saw in the previous section that if $f: X \rightarrow Y$ is smooth map between manifolds and $y \in Y$ is a regular value, then $f^{-1}(y)$ is a submanifold of X . What we would like to do is to generalise this, that is, take a submanifold in Y , pull it back under f , and get a submanifold in X . This is the motivation for transversality. The key properties of transversality are:

- (1) Stability under wiggling.
- (2) Any map f can be perturbed to become transverse.

Definition 3.0.1. Let $f: X \rightarrow Y$ be a map smooth. We say that f is *transverse* to a submanifold $Z \subseteq Y$, if for all $x \in X$ such that $f(x) = y \in Z$, we have

$$\text{Im}[df_x: T_x(X) \rightarrow T_y(Y)] + T_y(Z) = T_y(Y).$$

In which case, we write $f \pitchfork Z$.

Notice that if $f(X) \cap Z = \emptyset$, then f is transverse to Z , vacuously.

Example 3.0.1. Let $X = S^1$, $Y = \mathbb{R}^2$ and $Z = \{(x, -1) \in \mathbb{R}^2 : x \in \mathbb{R}\}$. $f: X \rightarrow Y$ is given by $f(x_1, x_2) = (x_1, x_2)$. The image of f intersects Z at the point $(0, -1) = f(0, -1)$. Now the image of $df_{(0, -1)}$ is spanned by the vector $(1, 0)$, which also spans $T_{(0, -1)}(Z)$. Therefore f is not transverse to Z .

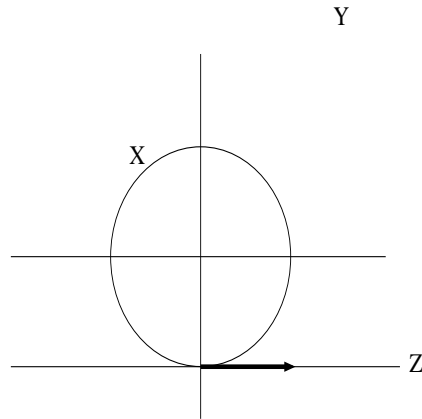

Example 3.0.2. Let $X = S^1$, $Y = \mathbb{R}^2$ and $Z = \{(0, x) \in \mathbb{R}^2 : x \in \mathbb{R}\}$. $f: X \rightarrow Y$ is given by $f(x_1, x_2) = (x_1, x_2)$. Now the image of f intersects Z at $(1, 0)$ and $(-1, 0)$. The image of $df_{(1,0)}$ is spanned by the vector $(0, 1)$, and the vector $(0, 1)$ spans $T_{(1,0)}(Z)$. Hence they intersect transversely at $(1, 0)$. They also intersect transversely at $(-1, 0)$. Therefore f is transverse to Z .

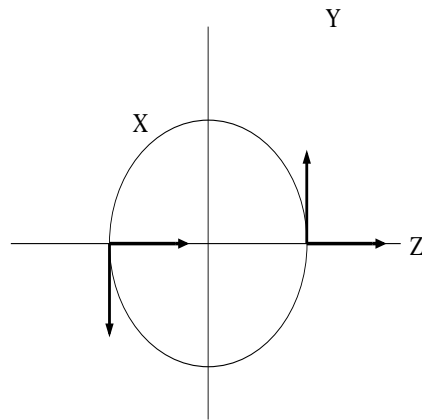

Example 3.0.3. Suppose Z is a single point. Then f is transverse to Z if, and only if, Z is a regular value.

Example 3.0.4. Let $f: S^1 \rightarrow S^2$ be given by $f(x_1, x_2) = (x_1, x_2, 0)$, and let $Z = \{(x_1, x_2, x_3) \in S^2 : x_1 = 0\}$.

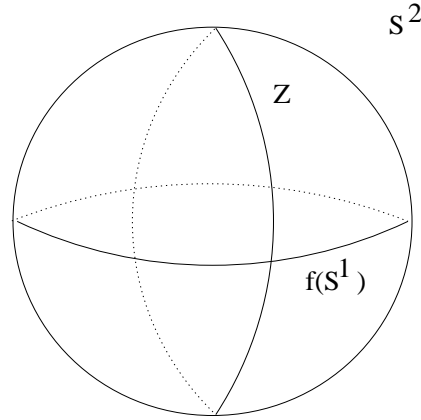

The image of f intersects Z at $(0, 1, 0)$ and $(0, -1, 0)$. Now $T_{(0,1,0)}Z$ is spanned by the vector $(0, 0, 1)$ and the image of $df_{(1,0)}$ is spanned by the vector $(1, 0, 0)$. These two vectors span $T_{(0,1,0)}(S^2)$. Therefore f intersects Z transversely at $(0, 1, 0)$. The same method can be used to show that f intersects Z transversely at $(0, -1, 0)$.

Example 3.0.5. A 3-plane and 4-plane are transverse in \mathbb{R}^6 if the intersection is one dimensional

Example 3.0.6. Let X and Z be submanifolds of Y . Then $i: X \rightarrow Y$ is transverse to Z if, and only if, for all $x \in X \cap Z$ we have $T_x(X) + T_x(Z) = T_x(Y)$. In which case we write $X \pitchfork Z$.

Example 3.0.7. Let V and W be linear subspaces of \mathbb{R}^n and $A: V \rightarrow \mathbb{R}^n$ be the identity map. Then A is transverse to W if $V + W = \mathbb{R}^n$.

Example 3.0.8. Let V be the set of symmetric matrices and W be the set of anti-symmetric matrices in $M_{n \times n}$. Let $C \in M_{n \times n}$. Then

$$C = \frac{1}{2}(C^T + C) + \frac{1}{2}(C - C^T).$$

Therefore $V + W = M_{n \times n}$. Hence, they intersect transversely.

Lemma 3.0.1. Suppose that $Z = g^{-1}(0)$, where $g: Y \rightarrow \mathbb{R}^k$ is smooth and 0 is a regular value of g . Then f is transverse to Z if, and only if, 0 is a regular value of $g \circ f$.

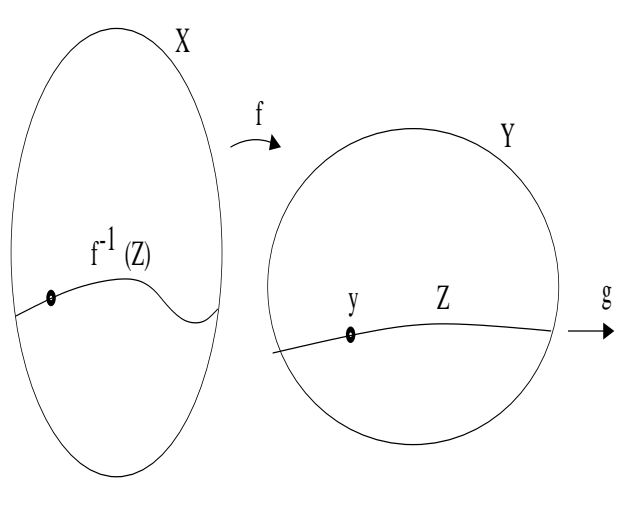

Proof. Zero is a regular value of $g \circ f$ if, and only if, $d_x(g \circ f)(T_x X) = \mathbb{R}^k$, for all $x \in (g \circ f)^{-1}$. We have

$$\begin{array}{ccccc}
 T_x(X) & \xrightarrow{df_x} & T_{f(x)}(Y) & \xrightarrow{dg_{f(x)}} & \mathbb{R}^k \\
 & \searrow & \swarrow & \nearrow & \\
 & & d(g \circ f)_x & &
 \end{array}$$

We know that $dg_{f(x)}(\text{Im } df_x) = \text{Im}(d_x(g \circ f))$ and $dg_x(T_{f(x)}(Z)) = 0$. Therefore we must have

$$df_x(T_x(X)) + T_{f(x)}(Z) = T_{f(x)}(Y).$$

Thus f is transverse to Z . □

Theorem 3.0.1. *Let $f: X \rightarrow Y$ be a smooth map which is transverse to $Z \subset Y$. Then $f^{-1}(Z)$ is a submanifold of X and*

$$\text{codim}_X(f^{-1}(Z)) = \text{codim}_Y(Z).$$

Proof. We have to show that for all $x \in f^{-1}(Z)$ there exists a neighbourhood $U_x \subset X$ of x and a submersion $\phi: U_x \cap X \rightarrow \mathbb{R}^k$ such that $U_x \cap X = \phi^{-1}(0)$. Let $x \in f^{-1}(Z)$, and let $z = f(x)$. Now Z is a submanifold so there exists a neighbourhood $U_z \subset Y$ and a submersion $g: U_z \cap Y \rightarrow \mathbb{R}^k$ such that $U_z \cap Y = g^{-1}(0)$. By the previous lemma we know that zero is a regular

value for $g \circ f$. Therefore $f^{-1}(U_z)$ is the neighbourhood of x we want and $g \circ f$ is the submersion we want. It is clear that

$$\text{codim}_X(f^{-1}(Z)) = \text{codim}_Y(Z).$$

□

Example 3.0.9. Let $X = S^2$, $Y = \mathbb{R}^3$ and $Z = \{(x, y, 0) \in \mathbb{R}^3 : x, y \in \mathbb{R}\}$. One can check that $f: S^2 \rightarrow Y$ given by $f(x, y, z) = (x, y, z)$ is transverse to Z . Now $f^{-1}(Z) = S^1$ and $\text{codim}_X(S^1) = \text{codim}_Y(Z) = 1$.

Y

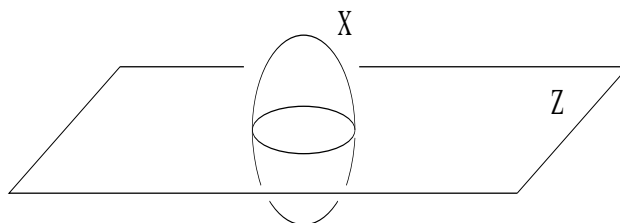

Example 3.0.10. Let P and Q be linear subspaces of \mathbb{R}^n , of dimensions k and l respectively. Then $\dim(P \cap Q) \geq k + l - n$. If P and Q have transverse intersection, then $\dim(P \cap Q) = k + l - n$.

Exercises

1. Let $f: X \rightarrow X$ be a smooth map with fixed point x . We say x is a *Lefschetz* fixed point of f if $df_x: T_x X \rightarrow T_x X$ has no fixed points. If all the fixed points of f are Lefschetz then f is called a Lefschetz map. Prove that if X is compact and if f is Lefschetz, then f has only finitely many fixed points.

4 Stability

Definition 4.0.2. We say S is a *stable class* if for every smooth manifold P and every smooth map $\Phi: X \times P \rightarrow Y$ the set $\Omega := \{p \in P : \Phi_p \in S\}$ is open in P . The map $\Phi_p: X \rightarrow Y$ is defined by $\Phi_p(x) = \Phi(x, p)$.

Example 4.0.11. Let $X = Y = P = \mathbb{R}$ and suppose $\Phi: X \times P \rightarrow Y$ is transverse to $\{0\}$ with $\Phi^{-1}(0) = S^1 \subset X \times P$. Let $\Omega = \{p \in P: \Phi_p: X \rightarrow Y \text{ is } \pitchfork \{0\}\}$. Let $S = \text{maps from } X \text{ to } Y \text{ which are transverse to } \{0\}$. Then $p \notin \Omega$ because the map $d\Phi_p$ is the zero map.

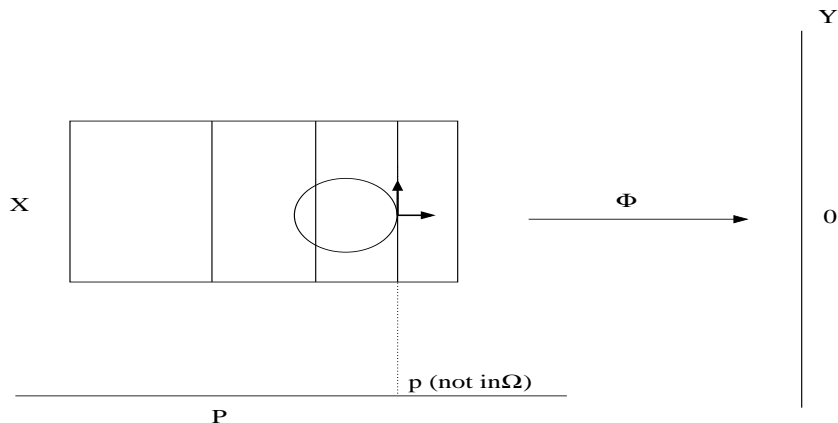

Theorem 4.0.2. *If X is compact, then the following classes of maps are stable:*

- (1) *Local diffeomorphisms,*
- (2) *Immersions,*
- (3) *Submersions,*
- (4) *Maps transversal to a closed (as a subset) submanifold $Z \subset Y$,*
- (5) *Embeddings,*
- (6) *Diffeomorphisms.*

Proof. We first prove the second case. Let $\Phi: X \times P \rightarrow Y$ be a smooth function, and let

$$\Omega = \{(x, p): \Phi_p \text{ is an immersion at } x\} \subseteq X \times P.$$

Claim: Ω is open in $X \times P$.

Proof of claim: The claim is a local statement, so without loss of generality we can assume $X \subset \mathbb{R}^k$, $Y \subset \mathbb{R}^l$ and $P \subset \mathbb{R}^m$ are all open subsets. Now let

$(x_0, p_0) \in \Omega$. Then

$$d\Phi_{(x_0, p_0)} = \begin{pmatrix} A & B \end{pmatrix},$$

where A is a $k \times l$ matrix and B is a $m \times l$ matrix. Hence

$$d((\Phi_{p_0})_{x_0}) = \begin{pmatrix} A \end{pmatrix}.$$

Now $(x_0, p_0) \in \Omega$ which implies the rank of A equals k . So there is a $k \times k$ minor $M_{(x_0, p_0)}$ in A such that $\det M \neq 0$. Since the determinant function is continuous we have $\{(x, p) : \det M_{(x, p)} \neq 0\} \subset X \times P$ is an open subset of Ω which contains (x_0, p_0) . Thus $\{p \in P : \Phi_p \text{ is an immersion}\} = \{p \in P : X \times \{p\} \subseteq \Omega\}$ is open because of the following lemma:

Lemma 4.0.2. *If X is compact and $\Omega \subseteq X \times P$ is open, then $\{p \in P : X \times \{p\} \subseteq \Omega\}$ is open.*

Proof.

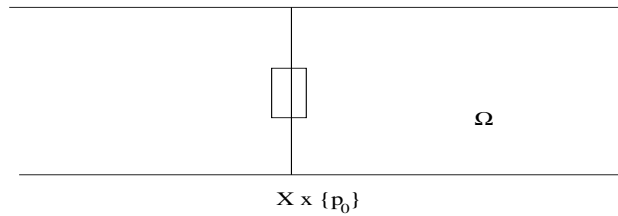

We want a neighbourhood $U \ni p_0$ such that $X \times U \subseteq \Omega$. For all $x \in X$ there exists a neighbourhood $U_x \ni p_0$ and a neighbourhood $V_x \ni x$ such that $V_x \times U_x \subseteq \Omega$. Since X is compact there exists a finite subcover $\{V_{x_1}, V_{x_2}, \dots, V_{x_k}\}$ of $\{V_x, x \in X\}$. Then let $U = U_{x_1} \cap \dots \cap U_{x_k}$. \square

We now prove case 4. Let S be the set of maps from X to Y which are transverse to $\{y\} \subset Y$. Let

$$\Omega = \{(x, p) : \Phi(x, p) \neq y\} \cup \{(x, p) : \Phi_p \text{ is a submersion at } x\}$$

It is clear that Ω is open. Hence $\{p \in P : X \times p \subseteq \Omega\}$ is also open. Now suppose $Z = g^{-1}(0)$, where $g : Y \rightarrow \mathbb{R}^l$ is a smooth map transverse to $\{0\}$ and S is the set of maps from X to Y which are transverse to Z . Let

$$\Omega' = \{(x, p) : \Phi(x, p) \in Z\} \cup \{(x, p) : g \circ \Phi : X \rightarrow \mathbb{R}^l \text{ is } \pitchfork \{0\}\}$$

which is equal to

$$\{(x, p) : g \circ \Phi_p \text{ is a submersion at } x\}$$

Showing Ω' is open requires showing that some minor has nonzero determinant. Let $Z \subset Y$ be an arbitrary closed submanifold, and let $S = \{f : X \rightarrow Y : f \pitchfork Z\}$. Now cover Y by charts V_i such that $V_i \cap Z$ is cut out in V_i by a function $g_i : V_i \rightarrow \mathbb{R}^l$, i.e., $g_i \pitchfork \{0\}$ and $V_i \cap Z = g_i^{-1}(0)$.

Example 4.0.12.

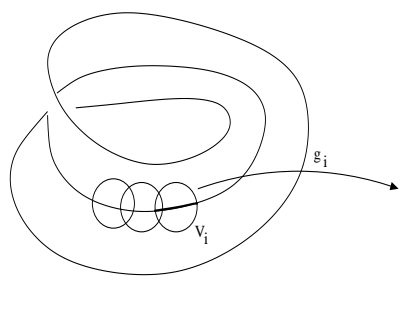

Define

$$\Omega_i = \{(x, p) : \Phi(x, p) \in V_i \text{ and either } \Phi(x, p) \notin Z \text{ or } g_i \circ \Phi_p \text{ is a submersion at } x\}.$$

Now Ω_i is open, hence $\Omega' = \cup \Omega_i$ is open. This concludes the proof of 4.

Now to prove case 5. Suppose $\Phi : X \times P \rightarrow Y$ is given and $\Phi_{p_0} : X \rightarrow Y$ is an embedding (If X is compact then an injective immersion is the same as an embedding). The idea is to show that if p is sufficiently close to p_0 , then Φ_p is also an embedding. From (2) we know Φ_p is an immersion when p is sufficiently close to p_0 . Assume that there exists a sequence $\{p_n\}$ in P such that $p_n \rightarrow p_0$ but Φ_{p_n} is not injective. Thus, there exists x_n and x'_n in X such that $x_n \neq x'_n$ but $\Phi(x_n, p_n) = \Phi(x'_n, p_n)$. By passing to a subsequence, we may assume $x_n \rightarrow x_0$ and $x'_n \rightarrow x'_0$. Therefore $\Phi(x_0, p_0) = \Phi(x'_0, p_0)$, which implies $x_0 = x'_0$. Now define $\tilde{\Phi} : X \times P \rightarrow Y \times P$ by $\tilde{\Phi}(x, p) = (\Phi(x, p), p)$. The map $\tilde{\Phi}$ is not injective in any neighbourhood of (x_0, p_0) . Hence, the local immersion theorem implies that $d\tilde{\Phi}_{(x_0, p_0)}$ is not injective. But

$$d\tilde{\Phi}_{(x_0, p_0)} = \begin{pmatrix} d(\Phi_{p_0})_{x_0} & ? \\ 0 & I \end{pmatrix},$$

which has maximal rank: All columns are linearly independent. Hence $d((\Phi_{p_0})_{x_0})$ is injective, a contradiction. This concludes the proof of (5). The remainder of the cases are left to the reader. \square

5 Imbeddings

5.1 Sard's Theorem

A subset $A \subseteq \mathbb{R}^n$ has measure zero if for all $\epsilon > 0$ there is a covering of A by countably many rectangular boxes of total volume less than ϵ .

Example 5.1.1. The set of rational numbers has measure zero.

Lemma 5.1.1. *The set $\mathbb{R}^m \subset \mathbb{R}^n$ has measure zero if $m < n$.*

Proof. Let $x_i, i = 1, 2, \dots$ be the integral points of \mathbb{R}^n , and let $C_i, i = 1, 2, \dots$ be unit volume (closed) cubes with centre x_i . Let $\epsilon > 0$ and we may as well assume that ϵ is small. The set

$$V := \bigcup_{i=1}^{\infty} C_i \times \epsilon[-(\frac{1}{2})^i, (\frac{1}{2})^1] \times \cdots \times \epsilon[-(\frac{1}{2})^i, (\frac{1}{2})^i]$$

has volume

$$\sum_{i=1}^{\infty} \epsilon^{n-m} (\frac{1}{2})^{(i-1)(n-m)} \leq 2\epsilon$$

Hence \mathbb{R}^m has measure zero in \mathbb{R}^n . □

Theorem 5.1.1. *The following statements hold:*

- (1) *A countable union of sets of measure zero has measure zero.*
- (2) *A subset of a set of measure zero has measure zero.*
- (3) *A box does not have measure zero.*

Definition 5.1.1. A map $f: \mathbb{R}^n \rightarrow \mathbb{R}^n$ is *Lipshitz* if there exists a $K > 0$ such that $\|f(x) - f(y)\| \leq K\|x - y\|$ for all x, y .

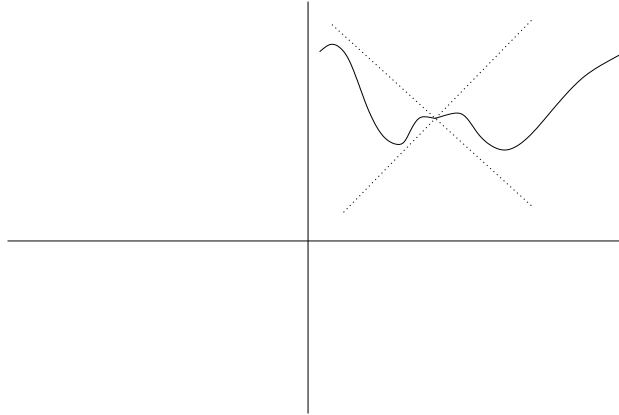

Definition 5.1.2. A map $f: \mathbb{R}^n \rightarrow \mathbb{R}^n$ is locally Lipschitz, if for every $x \in \mathbb{R}^n$ there exists a neighbourhood on which f is Lipschitz (when a locally Lipschitz function is restricted to a compact set it is Lipschitz.).

Proposition 5.1.1. If f is Lipschitz (or locally Lipschitz) and $A \subset \mathbb{R}^n$ has measure zero, then $f(A)$ has measure zero.

Proposition 5.1.2. Every smooth function $f: \mathbb{R}^n \rightarrow \mathbb{R}^n$ is locally Lipschitz.

Definition 5.1.3. Let X be a manifold. A subset $A \subset X$ has measure zero if for all parametrisations $\phi: U \rightarrow X$ the set $\phi^{-1}(A)$ has measure zero in $U \subset \mathbb{R}^k$.

Theorem 5.1.2 (Sard's Theorem). If $f: X \rightarrow Y$ is smooth, then the set of critical values has measure zero in Y .

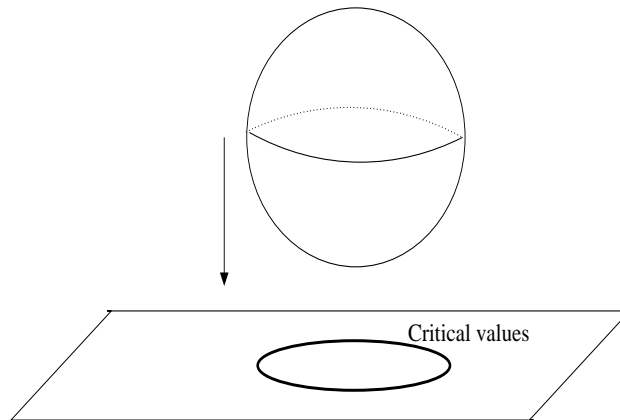

Sard's theorem can be used to prove the following theorem:

Theorem 5.1.3. *The following maps are generic:*

- (1) *Maps $X \rightarrow Y$ transverse to a submanifold $Z \subset Y$,*
- (2) *Embeddings $X^k \rightarrow \mathbb{R}^{2k+1}$, with X^k compact,*
- (3) *Immersions $X^k \rightarrow \mathbb{R}^{2k}$,*
- (4) *Morse functions $X \rightarrow \mathbb{R}$.*

Proposition 5.1.3. *Every $f: X \rightarrow \mathbb{R}^k$ can be perturbed so it is transverse to $0 \in \mathbb{R}^k$.*

Proof. Given $\epsilon > 0$, choose a regular value $y \in \mathbb{R}^k$ with $\|y\| < \epsilon$. Now replace f by $g: X \rightarrow \mathbb{R}^k$, given by

$$g(x) = f(x) - y.$$

Now zero is a regular value of g . □

Exercises

1. Give an example of a map which is not Lipschitz.
2. Give an example of a map where the critical values are dense.

6 Transversality Part II

Theorem 6.0.4 (Transversality Theorem). *Suppose that $F: X \times S \rightarrow Y$ is smooth and transverse to a submanifold $Z \subset Y$. Then for almost all $s \in S$ the map $F_s: X \rightarrow Y$, given by $F_s(x) = F(x, s)$ is transverse to Z .*

Example 6.0.2. Let $f: X \rightarrow \mathbb{R}^n$ be smooth, and let $Z \subset \mathbb{R}^n$ be a submanifold. Take $S = \mathbb{R}^n$ and define $F: X \times \mathbb{R}^n \rightarrow \mathbb{R}^n$ by $F(x, s) = f(x) + s$. Now F is a submersion and satisfies the assumptions of the theorem. So for almost all $a \in \mathbb{R}^n$, $f(x) + a$ is transverse to Z .

Proof.

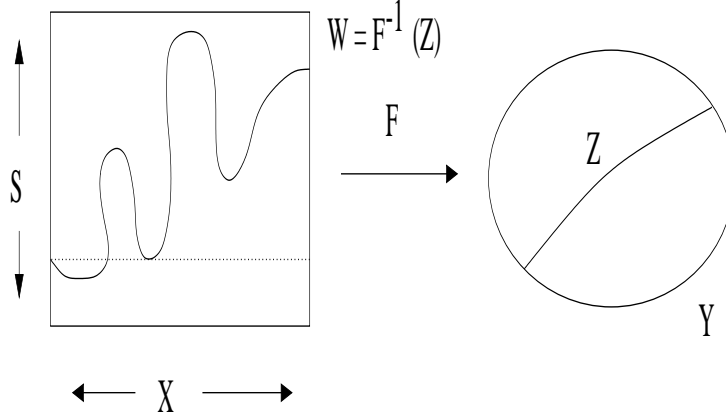

Let $W = F^{-1}(Z)$. This is a submanifold of $X \times S$, since $F \pitchfork Z$. Let $\pi: W \rightarrow S$ be the restriction of the projection of $X \times S \rightarrow S$.

Claim: If $s \in S$ is a regular value of π , then $F_s \pitchfork Z$ and Sard's theorem gives us the result.

Proof of Claim: Pick a regular value $s \in S$, we want to show that $F_s \pitchfork Z$. Choose some $x \in X$ such that $F_s(x) = z \in Z$. We know that $F(x, s) = z \in Z$ and $F \pitchfork Z$, hence

$$dF_{(x,s)}(T_{(x,s)}(X \times S)) + T_z(Z) = T_z(Y).$$

Now $d\pi_{(x,s)}: T_x(X) \times T_s(S) \rightarrow T_s(S)$ maps $T_{(x,s)}(W)$ onto $T_s(S)$ since s is a regular value. Therefore

$$T_{(x,s)}(X \times S) = T_{(x,s)}(X \times \{s\}) + T_{(x,s)}(W).$$

This last result is due to the following result from linear algebra:

Lemma 6.0.2. *Let V and W be vector spaces. Then $V \times 0$ and L span $V \times W$ if, and only if, $pr: V \times W \rightarrow W$ takes L onto W .*

Hence

$$dF_{(x,s)}(T_{(x,s)}(X \times S)) = dF_{(x,s)}(T_{(x,s)}(X \times \{s\}) + T_{(x,s)}(W)).$$

Since $dF_{(x,s)}(T_{(x,s)}(W)) \subseteq T_z(Z)$ we deduce that

$$dF_{(x,s)}(T_{(x,s)}(X \times \{s\})) + T_z(Z) = T_z(Y),$$

which implies that $d(F_s)_x(T_x(X)) + T_z(Z) = T_z(Y)$. □

7 Partitions of Unity

Lemma 7.0.3. *The function*

$$\varphi(x) = \begin{cases} 0 & \text{if } x \leq 0, \\ e^{-1/x} & \text{if } x > 0, \end{cases}$$

is smooth, but not analytic.

There are functions whose graphs look like

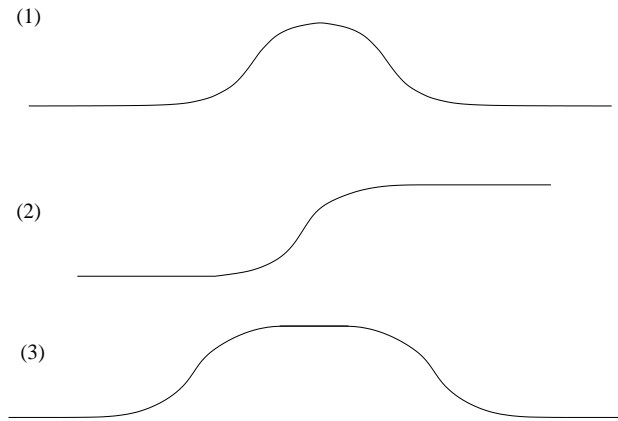

For example, the function $\psi(x) = \varphi(x+1)\varphi(1-x)$, where φ is the function in the previous lemma, gives the first graph. The second one is the graph of the function $\phi(x) = \int_{-\infty}^x \psi(t)dt$. Finally the third graph is obtained by $\chi(x) = \phi(1+x)\phi(1-x)$.

Proposition 7.0.4. *There exists a function $\mathbb{R}^n \rightarrow \mathbb{R}$ which is greater than or equal to zero on a ball of radius one and zero outside the ball of radius two.*

Definition 7.0.4. Let $\{U_\alpha\}$ be an open cover of a manifold M . A sequence $\theta_1, \theta_2, \dots$ of smooth functions $\theta_i: M \rightarrow \mathbb{R}$ is a *partition of unity* subordinate to $\{U_\alpha\}$ if:

- (1) $0 \leq \theta_i(x) \leq 1$ for all $i, x \in M$.
- (2) Each $x \in M$ has a neighbourhood on which all but finitely many θ_i are zero.
- (3) For all i there exists an α such that $\text{supp}(\theta_i) \subseteq U_\alpha$.
- (4) $\sum_{i=1}^{\infty} \theta_i(x) = 1$ for all $x \in M$.

Theorem 7.0.5. *Every open cover $\{U_\alpha\}$ admits a partition of unity subordinate to the open cover.*

Proof. First we construct an exhaustion of M , that is, show there exists compact subsets $K_1 \subset K_2 \subset \dots$ such that $\cup_{i=1}^\infty K_i = M$ and $K_i \subset \text{int } K_{i+1}$. To do this we use the fact that M is locally compact and second countable. Hence there exists basis V_1, V_2, \dots such that $\overline{V_i}$ is compact. We define K_i to be

$$\overline{V_1 \cup V_2 \cup \dots \cup V_i}.$$

There exists a $j > i$ such that $K_i \subset V_1 \cup V_2 \dots \cup V_j$. Thus a subsequence of K_1, K_2, \dots is an exhaustion. Let $A_i = K_i - \text{int } K_{i-1}$ ($K_0 = \emptyset$).

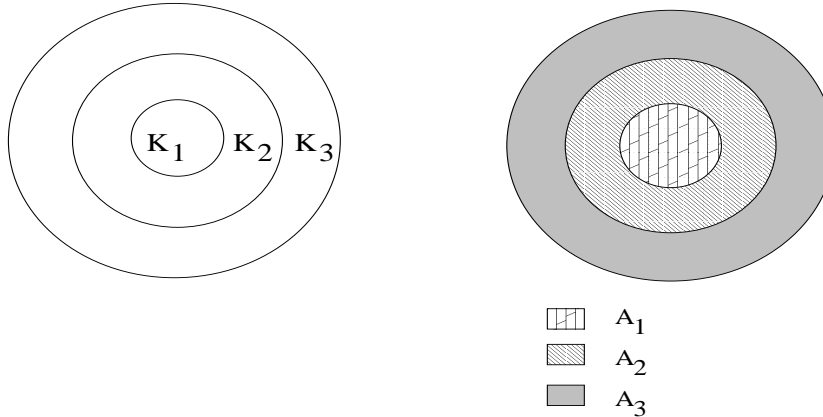

Now fix A_i . For every $x \in A_i$ choose a chart $V_x \ni x$ such that $V_x \subset U_\alpha$ for some α and $V_x \cap A_j = \emptyset$ unless $|i - j| \leq 1$. Also choose a smooth function $\theta_x: V_x \rightarrow [0, 1]$ such that $\theta_x \equiv 1$ on a neighbourhood of x and $\theta_x \equiv 0$ outside a compact set in V_x .

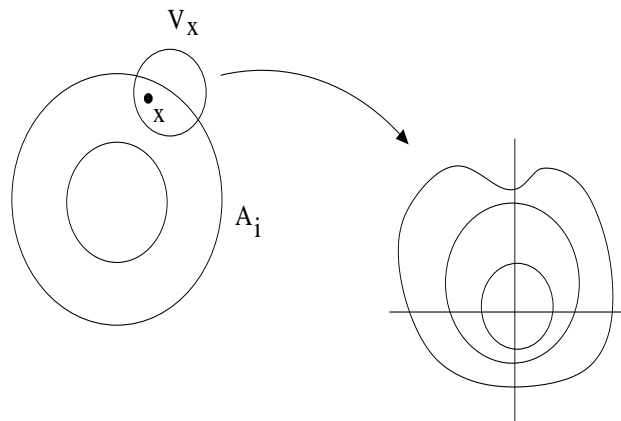

Let $x_1^i, x_2^i, \dots, x_{k(i)}^i$ be a finite collection of points such that $\{\theta_{x_i}\}$ cover A_i . The collection of functions $\{\theta_{x_j^i}\}_{i=1}^\infty$ satisfies one through three by construction. To get the fourth condition replace θ_{x_i} by $\theta_{x_j^i}/\psi$, where $\psi(x) = \sum_{m,p} \theta_{x_p^m}(x) > 0$. \square

Here are some applications of previous theorem.

Proposition 7.0.5. *Let $X \subseteq \mathbb{R}^n$ be an arbitrary subset and $f: X \rightarrow \mathbb{R}^k$ smooth. Then there exists a open set U , containing X , and a smooth extension $\tilde{f}: U \rightarrow \mathbb{R}^k$.*

Proof. For each $x \in X$ let U_x be a neighbourhood and $f_x: U_x \rightarrow \mathbb{R}^k$ be a smooth extension of $f|_{U_x \cap X}$.

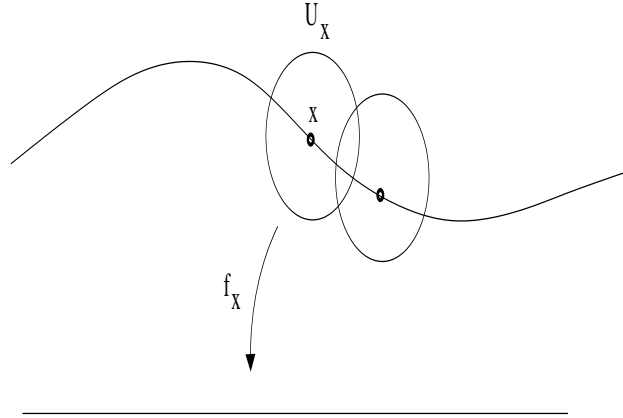

Let $U = \cup_{x \in X} U_x$, and let $\{\theta_i\}$ be a partition of unity subordinate to this open cover of U . For each i choose x_i so that $\text{supp}(\theta_i) \subseteq U_{x_i}$. Then define $\tilde{f}: U \rightarrow \mathbb{R}^k$ by $\tilde{f}(x) = \sum_{i=1}^\infty \theta_i(x) f_{x_i}(x)$. \square

Proposition 7.0.6. *Let $\epsilon > 0$, and let $f: M \rightarrow \mathbb{R}^k$ be a continuous function. Then there exists a smooth function $g: M \rightarrow \mathbb{R}^k$ such that $\|g(x) - f(x)\| < \epsilon$ for all $x \in M$.*

Proof. For each $x \in M$ choose a neighbourhood U_x , containing x , such that $\text{diam } f(U_x) < \epsilon$. Now choose a partition of unity subordinate to this open cover. For each θ_i choose x_i so that $\text{supp}(\theta_i) \subseteq U_{x_i}$. Now define $g(x) = \sum_{i=1}^\infty \theta_i(x) f(x_i)$. Then

$$\begin{aligned} \|g(x) - f(x)\| &\leq \|g(x) - f(x_j)\| + \|f(x_j) - f(x)\| \\ &< \|\sum \theta_i(x)(f(x_i) - f(x_j))\| + \epsilon \\ &< 3\epsilon. \end{aligned}$$

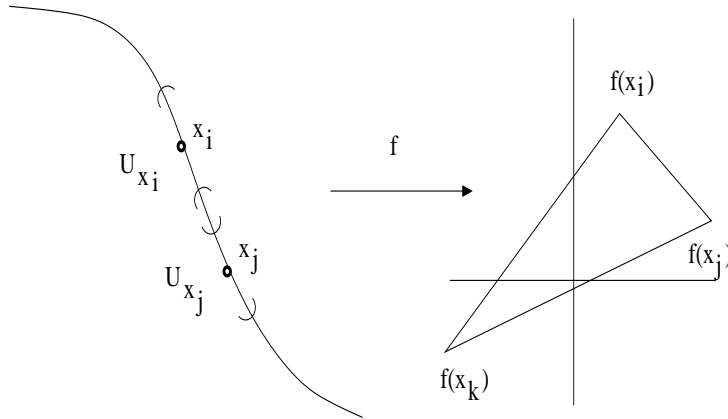

□

Theorem 7.0.6. *Every manifold M embeds in some \mathbb{R}^n .*

Proof. We shall only prove this in the case when M is compact. Let $\{U_\alpha\}$ be a covering of M by charts, and let $\{\theta_i\}$ be the partition of unity subordinate to $\{U_\alpha\}$ constructed as in theorem 15. Since M is compact only finitely many θ_i are non-zero. Say $\theta_1, \theta_2, \dots, \theta_k$ are non-zero functions. Let U_i be a chart with $\text{supp}(\theta_i) \subset U_i$, and let $\varphi_i: U_i \rightarrow \mathbb{R}^n$ be the chart map. Now define $F: M \rightarrow \mathbb{R}^n \times \dots \times \mathbb{R}^n \times \mathbb{R}^k$ by

$$F(x) = (\theta_1(x)\varphi_1(x), \dots, \theta_k(x)\varphi_k(x), \theta_1(x), \dots, \theta_k(x)).$$

This map is injective, for if $F(x) = F(y)$, then $\theta_i(x) = \theta_i(y)$ for all i . Now choose an i so that $\theta_i(x) \neq 0$. Then $\theta_i(x)\varphi_i(x) = \theta_i(x)\varphi_i(y)$, which implies $\varphi_i(x) = \varphi_i(y)$, hence $x = y$. Now dF_x is given by the following matrix:

$$\begin{pmatrix} d_x(\theta_1\varphi_1) \\ \vdots \\ d_x(\theta_k\varphi_k) \\ d_x(\theta_1) \\ \vdots \\ d_x(\theta_k) \end{pmatrix}.$$

For each $x \in M$ there exists a neighbourhood V and an i such that $\theta_i(p) = 1$ for all $p \in V$. Hence $d_x(\theta_i\varphi_i)$ is an isomorphism on V . Therefore dF_x is injective. Thus, F is an embedding. □

8 Vector Bundles

8.1 Tangent Bundle

Let X be a manifold in \mathbb{R}^n .

Definition 8.1.1. We define the *tangent bundle* of X to be

$$T(X) := \{(x, v) : x \in X, v \in T_x(X)\} \subseteq X \times \mathbb{R}^n \subseteq \mathbb{R}^n \times \mathbb{R}^n.$$

Example 8.1.1. If $U \subseteq \mathbb{R}^n$ is open, then $T(U) = U \times \mathbb{R}^n$.

Example 8.1.2. Consider the point $(a, b) \in S^1$, then we know that the tangent space at (a, b) is spanned by the vector $(-b, a)$. Therefore $T(S^1) = \{(a, b), \lambda(-b, a) : a^2 + b^2 = 1, \lambda \in \mathbb{R}\}$. This is diffeomorphic to $S^1 \times \mathbb{R}$ and the diffeomorphism is given by $((a, b), \lambda(-b, a)) \rightarrow ((a, b), \lambda)$.

The zero section of the tangent bundle is $X_0 := \{(x, 0) : x \in X\} \subset T(X)$. We have two natural maps $\pi: T(X) \rightarrow X$, given by $\pi(x, v) = x$, and $\sigma: X \rightarrow T(X)$, given by $\sigma(x) = (x, 0)$.

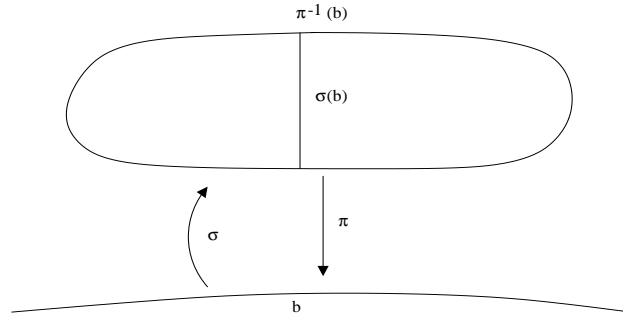

If $f: X \rightarrow Y \subset \mathbb{R}^m$ is smooth, define $df: T(X) \rightarrow T(Y)$ by

$$df(x, v) := (f(x), df_x(v)).$$

Lemma 8.1.1. *The map $df: T(X) \rightarrow T(Y) \subset \mathbb{R}^m \times \mathbb{R}^m$ is smooth.*

Proof. Since $f: X \rightarrow Y$ is smooth we can locally extend to a smooth map $\tilde{f}: U \rightarrow \mathbb{R}^m$. Now $d\tilde{f}: T(U) \rightarrow T(\mathbb{R}^m)$ is smooth and provides a local extension of df . Therefore df is smooth. \square

Corollary 8.1.1. *If $f: X \rightarrow Y$ is a diffeomorphism, then $df: T(X) \rightarrow T(Y)$ is a diffeomorphism.*

Proof. Let g be the inverse of f . Then $dg \circ df = d(g \circ f) = d(id) = id: T(X) \rightarrow T(X)$. \square

Proposition 8.1.1. *Let X be a manifold of dimension k . Then $T(X)$ is a manifold of dimension $2k$*

Proof. Let $\phi: U \rightarrow W$ be a local parametrisation for X . Then $d\phi: T(U) \rightarrow T(W)$ is a local parametrisation for $T(X)$. This is because $d\phi: T(U) \rightarrow T(W)$ is a diffeomorphism and $T(W)$ is open in $T(X)$. \square

Lemma 8.1.2. *Let X and Y be manifolds. Then $T(X \times Y) = T(X) \times T(Y)$.*

8.2 Cotangent Bundle

Recall: If V is a real vector space, then $V^* = \text{Hom}(V, \mathbb{R})$ is the dual space. If $\langle \cdot, \cdot \rangle$ is an inner product on V , then $v \rightarrow \langle \cdot, v \rangle$ is a map from V to V^* .

Definition 8.2.1. Let M be a manifold. We define the *Cotangent bundle* to be

$$T^*M := \{(x, \lambda) : x \in M, \lambda \in (T_x M)^*\}.$$

We then have a natural map $\pi: T^*M \rightarrow M$ given by $(x, \lambda) \rightarrow x$.

8.3 Normal Bundle

Let $M \subseteq \mathbb{R}^m$ be a submanifold. Then we define the total space of the *normal bundle* to be

$$N(M) := \{(x, v) : x \in M, v \perp T_x M\} \subseteq M \times \mathbb{R}^m.$$

We then have a natural map $\pi: N(M) \rightarrow M$ given by $(x, v) \rightarrow x$.

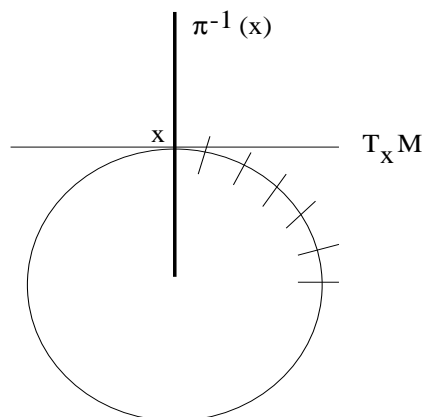

Example 8.3.1. Let $x = (x_1, x_2, \dots, x_{n+1}) \in S^n \subset \mathbb{R}^{n+1}$, then $T_x M^\perp$ is spanned by the vector $(x_1, x_2, \dots, x_{n+1})$.

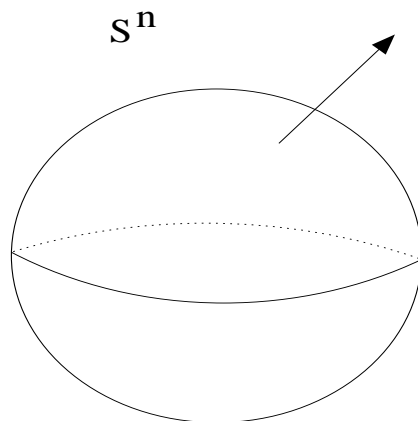

Therefore $N(S^n) = \{(x, \lambda x) : x \in S^n, \lambda \in \mathbb{R}\}$. Hence the normal bundle of the $S^n \subset \mathbb{R}^{n+1}$ is diffeomorphic to $S^n \times \mathbb{R}$.

Example 8.3.2. Let $X = \{(t, t^2) : t \in \mathbb{R}\} \subset \mathbb{R}^2$. Then X is just the graph of the function $y = x^2$. Now X is the zero set of the function $f: \mathbb{R}^2 \rightarrow \mathbb{R}$ given by $(x, y) \rightarrow x^2 - y$ and df_x is the 1×2 matrix $[2x \ 1]$. Therefore the tangent space at (x, y) is spanned by $(1, -2x)$, which implies the normal space at (x, y) is spanned by the vector $(2x, 1)$. Hence $N(X) = \{(x, x^2), \lambda(2x, 1) : x, \lambda \in \mathbb{R}\}$, which is diffeomorphic to $X \times \mathbb{R}$.

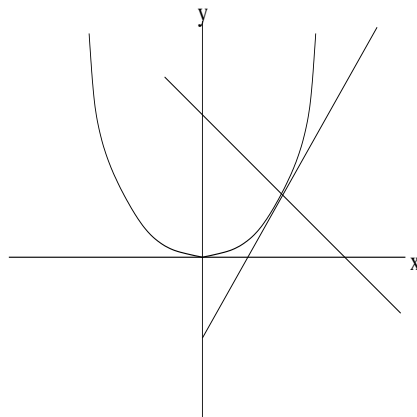

Definition 8.3.1. Let M be a submanifold of $Y \subset \mathbb{R}^m$. We define the normal bundle of M with respect to Y to be

$$N(M, Y) := \{(y, v) : y \in M, v \in T_y(Y), v \perp T_y(M)\}.$$

The figure below is an example of a nontrivial normal bundle

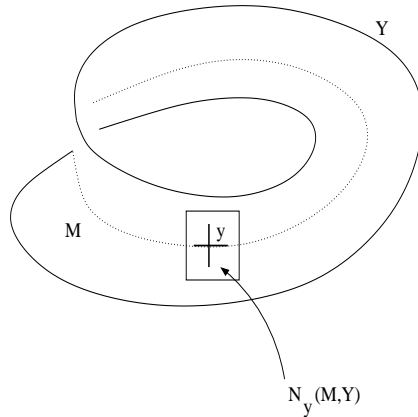

Example 8.3.3. Consider S^{k-1} as a submanifold of S^k via the usual embedding mapping $(x_1, \dots, x_k) \rightarrow (x_1, \dots, x_k, 0)$. Let x be the point $(x_1, \dots, x_k, 0)$ in S^{k-1} . Then $T_x(S^{k-1}) = \{(a_1, \dots, a_k, 0) \in \mathbb{R}^{k+1} : a_1x_1 + \dots + a_kx_k = 0\}$ and $T_x(S^k) = \{(a_1, \dots, a_{k+1}) \in \mathbb{R}^{k+1} : a_1x_1 + \dots + a_kx_k = 0\}$. Hence if $v \in T_x(S^k)$ and $v \perp T_x(S^{k-1})$, then v is of the form $(0, \dots, 0, a_{k+1})$. Therefore $N(S^{k-1}, S^k)$ is diffeomorphic to $S^{k-1} \times \mathbb{R}$.

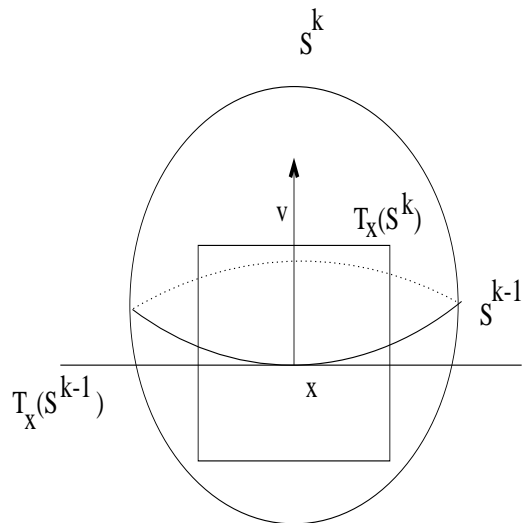

Let $M \subset \mathbb{R}^m$ be a compact manifold without boundary, and let $\epsilon > 0$. We define the ϵ -neighbourhood of M to be

$$M^\epsilon := \{x \in \mathbb{R}^m : d(x, M) < \epsilon\}.$$

Theorem 8.3.1 (Tubular Neighbourhood Theorem). *Let $M \subset \mathbb{R}^n$ be a compact manifold without boundary. Then:*

- (1) *When ϵ is sufficiently small, every point $y \in M^\epsilon$ has a unique closest point $\rho(y) \in M$.*

(2) The map $\rho: M^\epsilon \rightarrow M$ is a smooth retraction.

(3) There is a diffeomorphism $\varphi: M^\epsilon \rightarrow N(M)$ such that the following diagram commutes:

$$\begin{array}{ccc}
 M^\epsilon & \xrightarrow{\varphi} & N(M) \\
 \searrow \rho & & \swarrow \pi \\
 & M &
 \end{array}$$

Proof. Let $h: N(M) \rightarrow \mathbb{R}^n$ be given by $h(x, v) = x + v$.

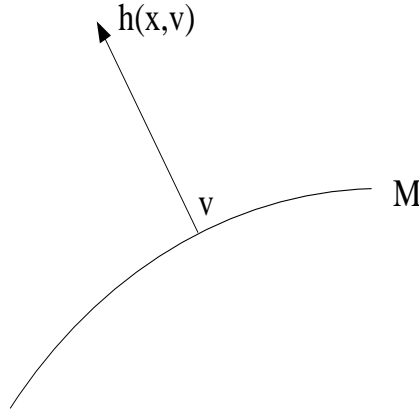

Claim: h is a local diffeomorphism at all points $(x, 0)$ of the zero section M of $N(M)$.

We need to show that $dh_{(x,0)}$ is surjective. Now $d(h|_M)_{(x,0)}: T_x M \rightarrow T_x M$ is just the identity map, hence $\text{Im}(dh_{(x,0)})$ contains $T_x M$. Now if we restrict h to the fiber above x , i.e., to $N_x(M) = T_x(M)^\perp$, we get constant + inclusion. So the derivative is inclusion, and its image is $N_x(M)$. Therefore $\text{Im}(dh_{(x,0)}) \supseteq T_x(M) + N_x(M) = \mathbb{R}^n$. This shows that $dh_{(x,0)}$ is surjective.

Now h is injective on M and it is a local diffeomorphism at all points of M . Thus, there exists a neighbourhood of M in $N(M)$, say U , such that $h|_U: U \rightarrow h(U)$ is a diffeomorphism. By compactness we can find an $\epsilon > 0$ such that

$$N^\epsilon(M) = \{(x, v) \in N(M): \|v\| < \epsilon\} \subset U.$$

Recall: If K is compact and U is an open neighbourhood of $\{x\} \times K$ in $X \times K$ then there exists a neighbourhood V of x such that $V \times K \subset U$.

We have $h: N^\epsilon(M) \rightarrow \mathbb{R}^n$ which is a diffeomorphism onto a neighbourhood of M .

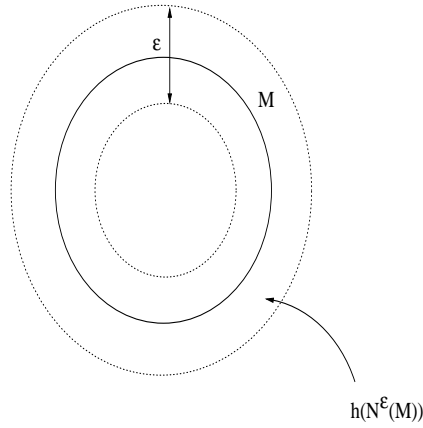

Claim: $N^\epsilon(M)$ is diffeomorphic to $N(M)$.

Proof of claim: Choose a diffeomorphism $\alpha: [0, \epsilon) \rightarrow [0, \infty)$ which is the identity in a neighbourhood of zero.

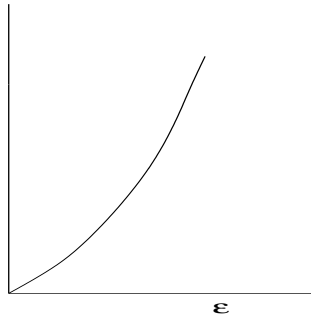

Now define $\phi: N^\epsilon(M) \rightarrow N(M)$ by

$$\phi(x, v) = \begin{cases} (x, \alpha(\|v\|)v/\|v\|) & , v \neq 0 \\ (x, 0) & v = 0. \end{cases}$$

□

Lemma 8.3.1. We have $h(N^\epsilon(M)) = \{y \in \mathbb{R}^n : d(y, M) < \epsilon\}$.

Proof The fact that $h(N^\epsilon(M)) \subset \{y \in \mathbb{R}^n : d(y, M) < \epsilon\}$ is clear ($h(x, v) - x = v$ has $\|v\| < \epsilon$).

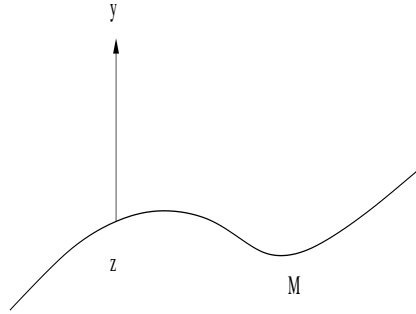

Pick y in $\{y \in \mathbb{R}^n : d(y, M) < \epsilon\}$, and let $z \in M$ be the closest point to y . Let γ be the curve in M with $\gamma(0) = z$. The function $t \rightarrow \|y - \gamma(t)\|^2$ has a minimum at $t = 0$. Differentiating and setting $t = 0$ we obtain:

$$-2y \cdot \gamma'(t)|_{t=0} + 2\gamma(t) \cdot \gamma'(t)|_{t=0} = 0.$$

This implies that $(z - y) \cdot \gamma'(0) = 0$. Hence $z - y \in T_z M^\perp$. Therefore $h(z, z - y) = y$. \square

Lemma 8.3.2. *For every point $y \in h(N^\epsilon(M))$ there is a unique closet point to y in M .*

We have to chose ϵ small enough so that the picture below does not occur.

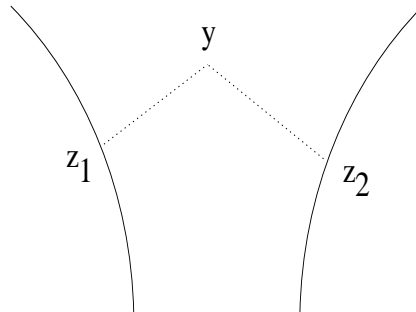

Generalisations:

(1) If M is compact, $M \subset Y \subset \mathbb{R}^n$, then there is a neighbourhood of M in Y diffeomorphic to $N(M, Y) = \{(x, v) : x \in M, v \in \mathbb{R}^n, v \in T_x Y, v \perp T_x M\}$ = normal bundle of M in Y .

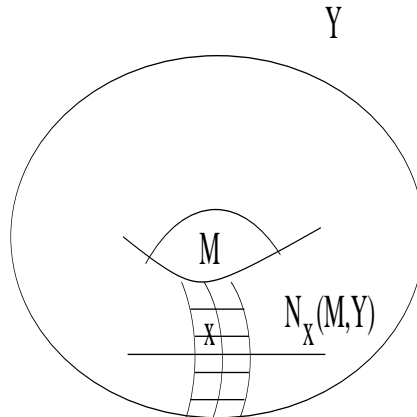

Use $(x, v) \rightarrow R(x + v)$ in place of h , where R is the nearest point retraction onto Y .

(2) We do not actually need M to be compact. Then instead of ϵ constant, work with a smooth function $\epsilon: M \rightarrow (0, \infty)$.

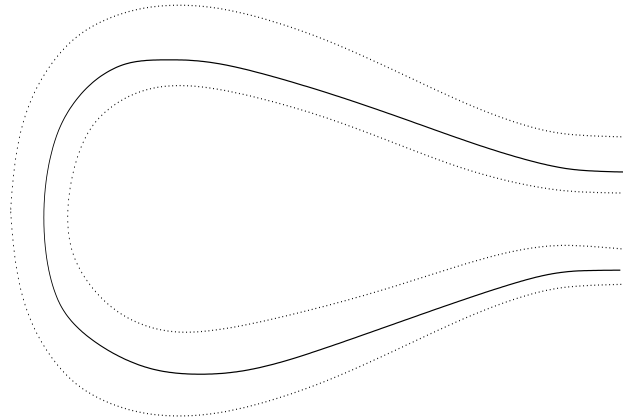

Exercises

1. Consider S^1 as a submanifold of $T^2 \subseteq \mathbb{R}^4$ via the usual embedding mapping $x \rightarrow (x, x_0)$, where $x_0 \in S^1$. Show that $N(S^1, T^2)$ is trivial.
2. Prove that there exists a diffeomorphism from an open neighbourhood Z in $N(Z, Y)$ onto an open neighbourhood of Z in Y .

8.4 Vector Bundles

Definition 8.4.1. A smooth *vector bundle* of rank k is a smooth map $\pi: E \rightarrow B$ between smooth manifolds together with a structure of a k -dimensional vector space on each $\pi^{-1}(b)$ such that the following local triviality condition holds: For all $b \in B$ there exists a neighbourhood W , containing

b , and a diffeomorphism $h: W \times \mathbb{R}^k \longrightarrow \pi^{-1}(W)$ such that the following diagram commutes:

$$\begin{array}{ccc}
 W \times \mathbb{R}^k & \xrightarrow{h} & \pi^{-1}(W) \\
 \searrow \text{Proj}_W & & \swarrow \pi \\
 & W &
 \end{array}$$

and for all $w \in W$, $h: \{w\} \times \mathbb{R}^k \longrightarrow \pi^{-1}(w)$ is a linear isomorphism. E is referred to as the total space and B is referred to as the base space. For brevity one often writes E for the vector bundle, letting the rest of the data be implicit.

This is the picture one should have in mind when thinking about what a vector bundle looks like locally.

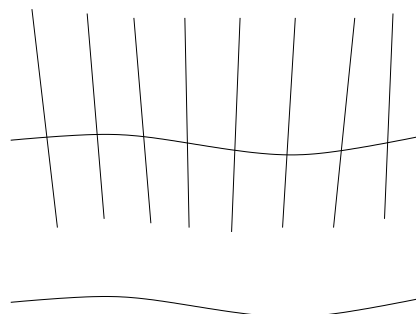

Definition 8.4.2. A *section* of a vector bundle $\pi: E \longrightarrow B$ is a map $s: B \longrightarrow E$ assigning to each $b \in B$ a vector $s(b)$ in the fiber $\pi^{-1}(b)$, equivalently $\pi \circ s = 1$.

Notice that every vector bundle has a canonical section, the *zero section*, whose value is the zero vector in each fiber. However, not all vector bundles have a non-zero section. We shall see later that the tangent bundle of S^n has a non-zero section if, and only if, n is odd.

Example 8.4.1. Let $E =$ Möbius band, $B = S^1$, and let $\pi: E \longrightarrow B$ be the projection map. This is called the Möbius bundle.

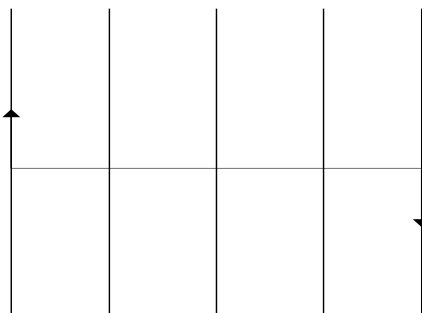

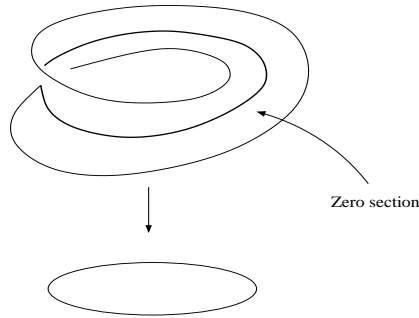

Example 8.4.2. Let $B = \mathbb{R}P^n$, $E = \{(l, x) : l \in B, x \in l\} \subseteq \mathbb{R}P^n \times \mathbb{R}^{n+1}$, and let $\pi: E \rightarrow B$ be the projection map $\pi(l, x) = l$. This is called the canonical line bundle over $\mathbb{R}P^n$. If $n = 1$, then we have the Möbius bundle.

Example 8.4.3. The canonical line bundle over $\mathbb{R}P^n$ has an orthogonal complement, the space

$$E^\perp := \{(l, v) \in \mathbb{R}P^n \times \mathbb{R}^{n+1} : v \perp l\}.$$

The projection $\pi: E^\perp \rightarrow \mathbb{R}P^n$ given by $\pi(l, v) = l$ is a vector bundle with fibers the orthogonal subspaces l^\perp , of dimension n .

Proposition 8.4.1. *The map $\pi: T^*M \rightarrow M$ is a smooth vector bundle.*

Example 8.4.4. The map $\pi: T(X) \rightarrow X$ is a smooth vector bundle.

Let \langle, \rangle denote the inner product in \mathbb{R}^n . Then $\langle v, w \rangle = v^T \cdot w$.

Lemma 8.4.1. *Suppose that $A: \mathbb{R}^m \rightarrow \mathbb{R}^k$ is a linear map. Then*

$$\langle Av, w \rangle = \langle v, A^T w \rangle$$

for all $v \in \mathbb{R}^m$ and $w \in \mathbb{R}^k$.

Corollary 8.4.1. *If A is surjective, then A^T is injective and $\text{Im}(A^T) = (\ker A)^\perp$.*

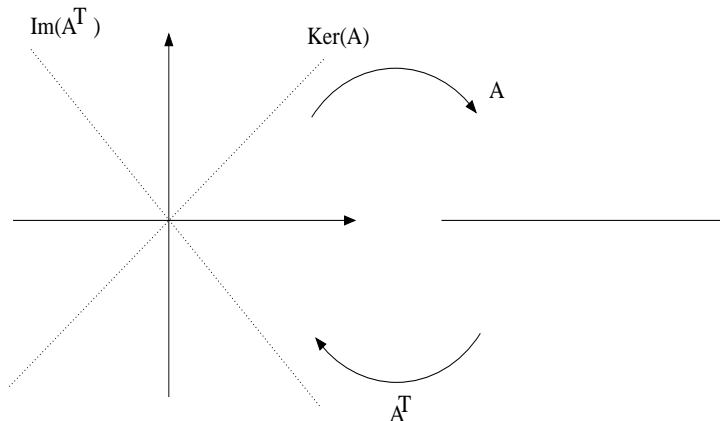

Proof. Suppose $w \in \mathbb{R}^k$ and $A^T w = 0$. Then $\langle v, A^T w \rangle = 0$ for all $v \in \mathbb{R}^m$. Therefore $\langle Av, w \rangle = 0$ for all $v \in \mathbb{R}^m$, which implies that $w = 0$. Let $v_2 = A^T w$ for some w . Then $\langle v_1, v_2 \rangle = \langle v_1, A^T w \rangle = \langle Av_1, w \rangle = 0$. We have $\dim \ker(A) = m - k$ and $\dim \text{Im}(A^T) = k$. Therefore $\text{Im}(A^T) = (\ker A)^\perp$. \square

Proposition 8.4.2. *The map $\pi: N(M) \longrightarrow M$ is a smooth vector bundle.*

Proof. We have to find local trivialisations of π . Given a point $\bar{y} \in M$, we work via a standard neighbourhood $\bar{U} \ni \bar{y}$ in \mathbb{R}^m that intersects M in a standard way. Thus, there exists a submersion $\phi: \bar{U} \longrightarrow \mathbb{R}^k$ such that $\bar{U} \cap M = \phi^{-1}(0)$. Therefore $T_y(M) = \ker(d\phi_y)$ and $N_y(M) = T_y(M)^\perp = \text{Im}(d\phi_y^T)$. Setting $U = \bar{U} \cap M$ we get trivialisations.

$$\begin{array}{ccccc} U \times \mathbb{R}^k & \xrightarrow{\varphi} & N(U) & \longrightarrow & N(M) \\ & \searrow \text{Proj}_U & \downarrow \pi & & \downarrow \pi \\ & & U & \longrightarrow & M \end{array}$$

Define $\varphi(y, v) = (y, d\phi_y^T(v))$, this is clearly a smooth function (both coordinates are smooth) and is bijective. The inverse $N(U) \rightarrow U \times \mathbb{R}^k$ is given by $(y, w) = (y, (d\phi_y \circ d\phi_y^T)^{-1} \circ d\phi_y(w))$, this is also smooth. \square

Example 8.4.5. Given a vector bundle $\pi: E \longrightarrow B$ and a subspace $A \subset B$, then $p: p^{-1}(A) \longrightarrow A$ is a vector bundle. We call this the restriction of E over A .

Definition 8.4.3 (Whitney Sum). The direct sum $E_1 \oplus E_2$ of two vector bundles over the same base space B is the vector bundle over B with total space

$$E := \{(v, w) \in E_1 \times E_2 : \pi_1(v) = \pi_2(w)\}$$

and the projection $\pi(v, w) = \pi_1(v) = \pi_2(w)$. The fiber $p^{-1}(b) = p_1^{-1}(b) \oplus p_2^{-1}(b)$.

Example 8.4.6. The direct sum $E \oplus E^\perp$ of the canonical line bundle $E \longrightarrow \mathbb{R}P^n$ with its orthogonal complement is isomorphic to the trivial bundle $\mathbb{R}P^n \times \mathbb{R}^{n+1}$ via the map $(l, v, w) \rightarrow (l, v + w)$. Hence in the case $n = 1$ we have that the direct sum of the Möbius bundle with itself is the trivial bundle $S^1 \times \mathbb{R}^2$.

Definition 8.4.4. A vector bundle E is *stably trivial* if $E \oplus E'$ is a trivial bundle for some trivial bundle E' .

Example 8.4.7. The tangent bundle of S^n is stably trivial, since the direct sum of the tangent bundle with the normal bundle is the trivial bundle $S^n \times \mathbb{R}^{n+1}$.

Theorem 8.4.1. *Every vector bundle E_1 over a compact base B has a complement, i.e., there exists E_2 such that the vector bundle $E_1 \oplus E_2$ is trivial.*

Proof. Choose an open cover U_1, \dots, U_m of B such that the vector bundle E_1 is trivial over U_i . Now let θ_i be a partition of unity with $\text{supp}(\theta_i) \subset U_i$. Define $f_i: U_i \times \mathbb{R}^n \rightarrow \mathbb{R}^n$ to be the projection map. Now define $g: E_1 \rightarrow B \times \mathbb{R}^{nm}$ by

$$g(v) = (\pi(v), \theta_1(\pi(v))f_1(v), \dots, \theta_m(\pi(v))f_m(v)).$$

Then g is a linear injection on each fiber. We now give \mathbb{R}^{nm} the usual inner product. Let

$$E_2 = \{(b, v) : v \in g(\pi^{-1}(b))^\perp\} \subseteq B \times \mathbb{R}^{nm}.$$

The space E_2 is a vector bundle over B and $E_1 \oplus E_2$ is a trivial bundle over B . □

Let $\text{Vect}_n(B)$ denote the isomorphism classes of vector bundles over B of rank n . Then the direct sum induces a map

$$\text{Vect}_n(B) \times \text{Vect}_m(B) \longrightarrow \text{Vect}_{n+m}(B)$$

such that

$$\text{Vect}(B) = \prod_{n=0}^{\infty} \text{Vect}_n(B)$$

becomes an abelian semigroup. The zero dimensional bundle $B \times \{0\}$ is the unit element.

To any abelian semigroup $(V, +)$ one can associate an abelian group $(K(V), +)$ defined as formal differences $a - b$ subject to the relation

$$(a + x) - (b + x) = a - b,$$

where $x \in V$ is arbitrary. When B is compact we define $KO(B) = K(\text{Vect}(B))$.

Definition 8.4.5. Let $f: X \rightarrow B$ be a smooth map and E_1 a vector bundle over B . The pull-back $f^*(E_1)$ is the vector bundle over X given by

$$E = \{(x, v) \in X \times E_1 : f(x) = \pi_1(v)\}$$

with $\pi: E \rightarrow X$ the projection onto X .

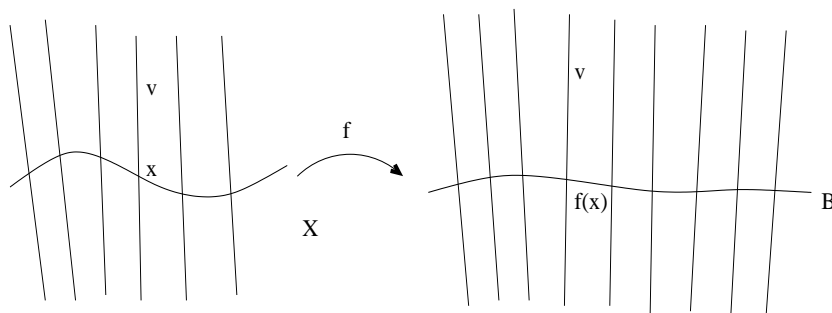

Example 8.4.8. The pull-back of the Möbius bundle under the map $f: S^1 \rightarrow S^1$ given by $z \rightarrow z^2$ is the trivial bundle.

Example 8.4.9. Let f be the map from S^1 to a genus two surface as indicated in the diagram below. Let E be the tangent bundle of the genus two surface. Then the pull-back bundle $f^*(E)$ is the vector bundle over S^1 with total space $S^1 \times \mathbb{R}^2$.

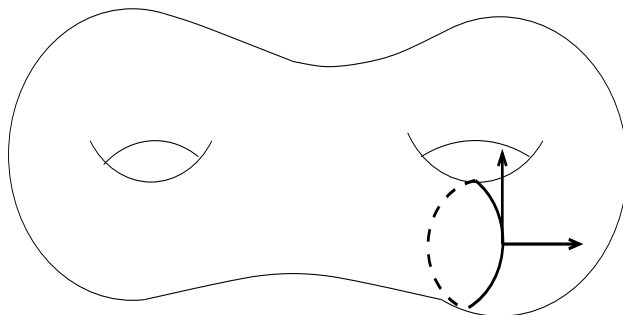

Definition 8.4.6. If $\pi: E \rightarrow B$ and $\pi': E' \rightarrow B'$ are two vector bundles, a *smooth bundle map* from E to E' is a pair of smooth maps $F: E \rightarrow E'$ and $f: B \rightarrow B'$ such that the following diagram commutes:

$$\begin{array}{ccc} E & \xrightarrow{F} & E' \\ \pi \downarrow & & \downarrow \pi' \\ B & \xrightarrow{f} & B' \end{array}$$

and with the added property that for each $b \in B$, the restricted map

$$F: \pi^{-1}(b) \longrightarrow \pi'^{-1}(f(b))$$

is a linear map. If F is a diffeomorphism, then it is called a *smooth bundle isomorphism*. Two vector bundles are *smoothly isomorphic* if there exists a smooth bundle isomorphism between them.

Example 8.4.10. If $f: M \longrightarrow N$ is smooth, then $df: T(M) \longrightarrow T(N)$ is a bundle map.

Lemma 8.4.2. *A smooth map between two vector bundles $f: E_1 \longrightarrow E_2$ over the same base space B is an isomorphism if it takes each fiber $p_1^{-1}(b)$ to the corresponding fiber $p_2^{-1}(b)$ by a linear isomorphism.*

Lemma 8.4.3. *If f_0 and f_1 are homotopic, then $f_0^*(E)$ and $f_1^*(E)$ are isomorphic.*

Corollary 8.4.2. *Every vector bundle over a contractible base space is trivial.*

Definition 8.4.7. A connected n -manifold M is said to be *parallelizable* if the tangent bundle of M is trivial, that is, $T(M)$ is smoothly isomorphic to the product bundle $\mathbb{R}^n \times M$.

We have shown that S^1 is parallelizable. The only other spheres of positive dimension that are parallelizable are S^3 and S^7 . Showing that S^1 , S^3 and S^7 are the only parallelizable spheres has a nice algebraic consequence: If \mathbb{R}^n has the structure of a division algebra over \mathbb{R} , then $n = 1, 2, 4$ or 8 , for if \mathbb{R}^n has the structure of a division algebra over \mathbb{R} , then we would be able to show that the sphere S^{n-1} is parallelizable. The idea of this method is shown in the exercises on page 77.

Theorem 8.4.2. *Let M be a compact n -manifold. Then M has an immersion into \mathbb{R}^{2n} and an embedding into \mathbb{R}^{2n+1} .*

Proof. We shall only prove that there exists an embedding into \mathbb{R}^{2n+1} . Let $f_a: \mathbb{R}^N \longrightarrow a^\perp \cong \mathbb{R}^{N-1}$ be the orthogonal projection.

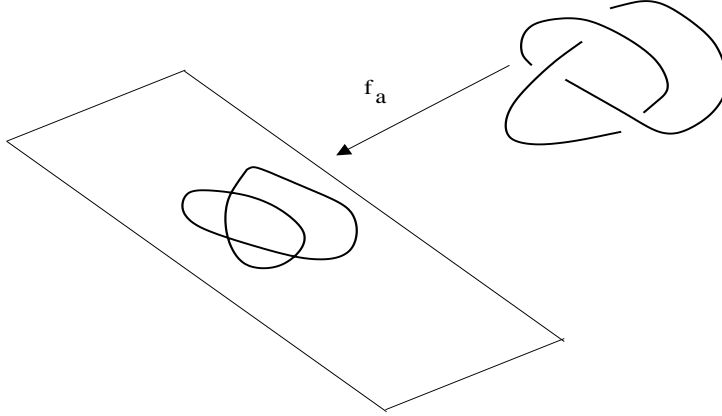

Define $g: T(M) \rightarrow \mathbb{R}^N$ by $g(x, v) = v$ and $h: M \times M \times \mathbb{R} \rightarrow \mathbb{R}^N$ by $h(x, y, t) = t(x - y)$. If $N > 2n + 1$, then by Sard's theorem we can choose an $a \in \mathbb{R}^n$ such that $a \neq 0$ is in neither image. The map $f_a: M \rightarrow \mathbb{R}^{N-1}$ is injective, since suppose $f_a(x) = f_a(y)$ with $x \neq y$, then $x - y = at$. But then $h(x, y, 1/t) = a$, which contradicts our choice of a . The map $f_a: M \rightarrow \mathbb{R}^{N-1}$ is also an immersion. For suppose $df_a(v) = f_a(v) = 0$ with $v \neq 0$, then $v = at$. Hence $g(x, v/t) = a$, which again contradicts our choice of a . If our manifold was not immersed in \mathbb{R}^{2n+1} , then this procedure allows us to keep on dropping down a dimension until we obtain a one-one immersion into \mathbb{R}^{2n+1} . For compact manifolds one-one immersions are the same as embeddings. \square

Lemma 8.4.4. *For any manifold M , there exists a smooth proper map $\rho: M \rightarrow \mathbb{R}$.*

Proof. Let $\{u_\alpha\}$ be an open cover with $\overline{U_\alpha}$ compact, and let θ_i be a partition of unity subordinate to this open cover. Define $\rho: M \rightarrow \mathbb{R}$ by

$$\rho = \sum_{i=1}^{\infty} i\theta_i$$

Then ρ is smooth by local finiteness of the partition of unity.

Suppose $\rho(x) \leq j$, then $\theta_i(x) > 0$ for some $i \leq j$. Hence

$$\begin{aligned} \rho^{-1}([0, j]) &\subset \cup_{i=1}^j \{x: \theta_i(x) \neq 0\} \\ &\subset \cup_{i=1}^j \overline{U_\alpha} \quad \text{where } \text{supp}(\theta_i) \subset U_\alpha \end{aligned}$$

Therefore $\rho^{-1}([0, j])$ is compact. Thus, $\rho^{-1}(K)$ is compact for any compact set $K \subset \mathbb{R}$. \square

We are now ready to prove a stronger version of the previous theorem

Theorem 8.4.3. *Any manifold M embeds into \mathbb{R}^{2n+1} .*

Proof. By the previous result, there exists a one-to-one immersion $M \rightarrow \mathbb{R}^{2n+1}$. Now compose this map with a diffeomorphism $\mathbb{R}^{2n+1} \rightarrow B_1(0)$. Thus, we have a diffeomorphism $f: M \rightarrow B_1(0)$. Let $\rho: M \rightarrow \mathbb{R}$ be a proper map. Define $F: M \rightarrow \mathbb{R}^{2n+2}$ by

$$F(p) = (f(p), \rho(p)).$$

Just as before each vector $a \in \mathbb{R}^{2n+2}$ defines a projection $\pi: \mathbb{R}^{2n+2} \rightarrow a^\perp \cong \mathbb{R}^{2n+1}$. As before $\pi \circ F: M \rightarrow \mathbb{R}^{2n+1}$ is a one-to-one immersion for almost all $a \in S^{2n+1}$. We choose such an $a \neq (0, \dots, \pm 1)$. Suppose that $\pi \circ F$ is not proper. Then there exists a sequence $\{x_n\}$ in M such that $|\pi \circ F(x_n)| \leq C$ and $\rho(x_n) \rightarrow \infty$ as $n \rightarrow \infty$. Now $F(x_n) - \pi \circ F(x_n)$ is a multiple of a for all n . Hence

$$w_n = \frac{1}{\rho(x_n)} [F(x_n) - \pi \circ F(x_n)]$$

is a multiple of a for all n . As $n \rightarrow \infty$

$$\frac{F(x_n)}{\rho(x_n)} = \left(\frac{f(x_n)}{\rho(x_n)}, 1 \right) \rightarrow (0, \dots, 0, 1)$$

because $|f(x_n)| < 1$ for all n . Also,

$$\left| \frac{\pi \circ F(x_n)}{\rho(x_n)} \right| \leq \frac{C}{\rho(x_n)} \rightarrow 0$$

This implies that w_n converges to $(0, 0, \dots, 0, 1)$. Each w_n is a multiple of a , therefore the limit is a multiple of a , a contradiction. \square

Whitney actually proved the two following theorems.

Theorem 8.4.4 (Whitney's Immersion Theorem). *Let M be a n -dimensional manifold. Then there exists an immersion into \mathbb{R}^{2n-1} .*

Theorem 8.4.5 (Whitney's Embedding Theorem). *Let M be a n -dimensional manifold. Then there exists an embedding into \mathbb{R}^{2n} .*

One way ask can we go further. The answer to this is no! For example, we shall see later that $\mathbb{R}P^2$ does not embed into \mathbb{R}^3 .

Exercises

1. Show that the map $\pi: TX \rightarrow X$ is a submersion, hence $\pi^{-1}(p) = T_pX$ is a submanifold of TX .
2. Let $f: M \rightarrow S^n$ be a smooth map between manifolds such that $\dim M < n$. Show that f is homotopic to a constant. In particular, show that S^n is simply connected if $n > 1$.
3. Show that the Möbius bundle and the product bundle $\pi: S^1 \times \mathbb{R} \rightarrow S^1$ are not smoothly isomorphic. Hint: Show that if they are smoothly isomorphic, then there is a diffeomorphism between the complements of the zero section. It is a fact that the only rank 1 vector bundles with base space S^1 are the product bundle and the Möbius bundle.
4. Show that the pull-pack bundle of a trivial bundle is trivial.
5. Let E be the canonical line bundle over $\mathbb{R}P^n$. Now each point in $\mathbb{R}P^n$ is represented by a line l in \mathbb{R}^{n+1} and the fibre over l is l itself. The line l meets the sphere S^n in two points x and $-x$. Therefore the tangent space $T_l\mathbb{R}P^n$ is obtained by identifying T_xS^n and $T_{-x}S^n$ via the correspondence $v \rightarrow -v$. Thus, any tangent vector $X \in T_l\mathbb{R}P^n$ is expressed as a pair $\{(x, v), (-x, -v)\}$. Show that such pairs induce a linear map $f_X: l \rightarrow l^\perp$ and vice versa. Hence deduce a bundle isomorphism $T\mathbb{R}P^n \cong \text{Hom}(E, E^\perp)$.
6. Show that the pull-back of the Möbius bundle by the map $f: S^1 \rightarrow S^1$ given by $z \rightarrow z^n$ is the trivial bundle if n is even and the Möbius bundle if n is odd.
7. Prove corollary 6.
8. (Unit tangent bundle) Let M be a manifold of dimension n and TM its tangent bundle. We define the unit tangent bundle by

$$UT(M) := \{(m, v) \in TM: \|v\| = 1\}.$$

Show that the unit tangent bundle is a manifold of dimension $2n - 1$.

9 Vector Fields

Definition 9.0.8. Let M be a manifold. A *smooth vector field* is a smooth function $X: M \rightarrow TM$ such that $\pi \circ X = id_M$, where $\pi: TM \rightarrow M$ is given by $(x, v) \rightarrow x$.

The set of smooth vector fields on M has a natural vector space structure. We shall denote this vector space by $\Gamma(M)$. Let $f \in C^\infty(M)$, and let $X \in \Gamma(M)$. Then we define $fX(p) = (p, f(p)X_p)$, where $X(p) = (p, X_p)$. Thus, $\Gamma(M)$ is a module over $C^\infty(M)$.

Example 9.0.11. Let $M = S^1$ and define $X: M \rightarrow TM$ by

$$X(a, b) = ((a, b), (-b, a)).$$

Then X defines a smooth vector field on M .

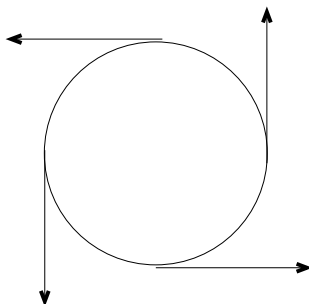

Example 9.0.12. Let $M = S^3$ and define $X: M \rightarrow TM$ by

$$X(a, b, c, d) = ((a, b, c, d), (-b, a, -d, c)).$$

Then X defines a smooth vector field on S^3 .

Example 9.0.13. Let $M = T^2 = S^1 \times S^1$. A point p in T^2 can be written in the form $((a, b), (x, y))$, where $a^2 + b^2 = x^2 + y^2 = 1$. Now define $X: M \rightarrow TM$ by

$$X(p) = (p, (0, (-y, x))).$$

Then X defines a smooth vector field on T^2 .

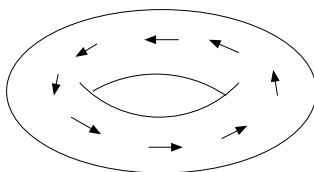

Definition 9.0.9. Let $F: M \rightarrow N$ be a smooth map between manifolds, and let X and Y be vector fields on M and N respectively. Then X and Y are F -related if for each $q \in N$ and $p \in F^{-1}(q)$ we have $dF_p(X_p) = Y_q$.

Theorem 9.0.6. Let $F: M \rightarrow N$ be a diffeomorphism. Then each vector field Y on N is F -related to a uniquely determined vector field X on M .

Proof. Since F is a diffeomorphism the map $dF_p: T_pM \rightarrow T_{F(p)}N$ is a linear isomorphism. Thus, each vector Y_q uniquely determines a vector X_p , where $p = F^{-1}(q)$. We leave it to the reader to check that this vector field is smooth. \square

Definition 9.0.10. Let $f: M \rightarrow \mathbb{R}$ be a smooth function. We define $X(f)$ to be the function $df \circ X: M \rightarrow \mathbb{R}$. In other words, $X(f)(p)$ is just the directional derivative of f at p in the direction X_p .

If X and Y are vector fields the composition of operators $Y \circ X$ is generally not given by a vector field. Let us calculate in local coordinates in \mathbb{R}^n .

Let

$$X = \sum_{i=1}^n a_i \frac{\partial}{\partial x_i},$$

and

$$Y = \sum_{j=1}^n b_j \frac{\partial}{\partial x_j}.$$

By definition

$$\left(\frac{\partial}{\partial x_i} \right) (f) = \frac{\partial f}{\partial x_i}.$$

Hence

$$\begin{aligned} YX(f) &= Y \left(\sum_{i=1}^n a_i \frac{\partial f}{\partial x_i} \right) \\ &= \sum_{i=1}^n Y \left(a_i \frac{\partial f}{\partial x_i} \right) \\ &= \sum_{j=1}^n \sum_{i=1}^n b_j \frac{\partial}{\partial x_j} \left(a_i \frac{\partial f}{\partial x_i} \right) \\ &= \sum_{j=1}^n \sum_{i=1}^n b_j \left(\frac{\partial a_i}{\partial x_j} \frac{\partial f}{\partial x_i} + a_i \frac{\partial^2 f}{\partial x_i \partial x_j} \right). \end{aligned}$$

Similarly,

$$XY(f) = \sum_{i=1}^n \sum_{j=1}^n a_i \left(\frac{\partial b_j}{\partial x_i} \frac{\partial f}{\partial x_j} + b_j \frac{\partial^2 f}{\partial x_i \partial x_j} \right).$$

Notice that the difference $XY - YX$, however, is a vector field:

$$(XY - YX)(f) = \sum_{k=1}^n \left(- \sum_{j=1}^n b_j \frac{\partial a_k}{\partial x_j} + \sum_{i=1}^n a_i \frac{\partial a_k}{\partial x_i} \right) \frac{\partial f}{\partial x_k}.$$

Thus, we have proven the following lemma for the case $M = \mathbb{R}^n$:

Lemma 9.0.5. *Let M be a manifold, and let X and Y be vectors fields on M . Then $XY - YX$ is a vector field on M .*

$[X, Y] := XY - YX$ is called the *Poisson bracket* or *Lie bracket*.

Example 9.0.14. The two vector fields X and Y on \mathbb{R}^n with coordinates (x_1, \dots, x_n) given by

$$X = \frac{\partial}{\partial x_i} \quad \text{and} \quad Y = \frac{\partial}{\partial x_j},$$

have Lie bracket

$$\begin{aligned} [X, Y](f) &= \frac{\partial}{\partial x_i} \left(\frac{\partial f}{\partial x_j} \right) - \frac{\partial}{\partial x_j} \left(\frac{\partial f}{\partial x_i} \right) \\ &= \frac{\partial^2 f}{\partial x_i \partial x_j} - \frac{\partial^2 f}{\partial x_j \partial x_i} \\ &= 0. \end{aligned}$$

Lemma 9.0.6. *Let X and Y be two smooth vector fields on a manifold M , and let $f, g \in C^\infty(M)$. Then*

$$[fX, gY] = fg[X, Y] + fX(g)Y - gY(f)X.$$

Proof. Let h be a smooth function. Then

$$\begin{aligned} [fX, gY](h) &= fX(gY(h)) - gY(fX(h)) \\ &= gfX(Y(h)) + Y(h)fX(g) - fgY(X(h)) - X(h)gY(f) \\ &= fg[X, Y](h) + fX(g)Y(h) - gY(f)X(h). \end{aligned}$$

Therefore

$$[fX, gY] = fg[X, Y] + fX(g)Y - gY(f)X.$$

□

9.1 Lie Algebras

Definition 9.1.1. A real *Lie algebra* \mathcal{L} is a vector space over \mathbb{R} if in addition to its vector space structure it possesses a product, that is, a map $\mathcal{L} \times \mathcal{L} \rightarrow \mathcal{L}$ taking the pair (X, Y) to $[X, Y]$, which has the following properties:

$$(1) \quad [\alpha_1 X_1 + \alpha_2 X_2, Y] = \alpha_1 [X_1, Y] + \alpha_2 [X_2, Y].$$

$$(2) [X, \alpha_1 Y_1 + \alpha_2 Y_2] = \alpha_1 [X, Y_1] + \alpha_2 [X, Y_2].$$

$$(3) \text{ It is skew commutative: } [X, Y] = -[Y, X].$$

(4) It satisfies the *Jacobi identity*:

$$[X, [Y, Z]] + [Y, [Z, X]] + [Z, [X, Y]] = 0.$$

Example 9.1.1. The vector space \mathbb{R}^3 with the usual vector product from vector calculus is a Lie algebra.

Example 9.1.2. Let M be a manifold. Then $\Gamma(M)$ with the Lie bracket is a Lie algebra.

Definition 9.1.2. A Lie algebra \mathcal{L} is *abelian* if $[X, Y] = 0$ for all $X, Y \in \mathcal{L}$.

Example 9.1.3. The Lie algebra $\Gamma(\mathbb{R}^n)$ is abelian.

9.2 Integral Curves

Let M be a manifold, and let X be a vector field on M .

Definition 9.2.1. An *integral curve* of X is a curve $\rho : (a, b) \rightarrow M$ such that $\rho'(t) = X_{\rho(t)}$.

Example 9.2.1. Let $M = \mathbb{R}$, and let $X(t) = t \frac{d}{dt}$. Then an integral curve is $y = Ce^x$.

Example 9.2.2. Let $M = S^1$. Then the curve $\rho(t) = (\cos t, \sin t)$ is an integral curve to the vector field $X(x, y) = (-y, x)$.

Example 9.2.3. Let $M = \mathbb{R}$, and let $X(t) = -t^2 \frac{d}{dt}$. Then the curves $\rho(t) = 0$ and $\phi(t) = \frac{1}{1-t}$ are both integral curves for this vector field.

Example 9.2.4. Consider the differential equation $\frac{dy}{dx} = x^{2/3}$. Then $\rho(t) = 0$ and $\rho(t) = \frac{1}{27}t^3$ are both integral curves to this vector field.

The natural questions that arise are: When do integral curves exist, and when are they unique? We shall show that for Lipschitz vector fields integral curves exist locally and are unique.

Theorem 9.2.1 (Contraction Mapping Theorem). *Let M be a complete non-empty metric space and $F: M \rightarrow M$ a contraction. Then F has a unique fixed point.*

Theorem 9.2.2. *Let $f: U \rightarrow \mathbb{R}^n$ be any function, where $U \subset \mathbb{R}^n$ is open. Let $x_0 \in U$, and let $a > 0$ be a number such that the closed ball $\overline{B_{2a}(x_0)}$ is contained in U . Suppose that*

(1) *f is bounded by L on $\overline{B_{2a}(x_0)}$.*

(2) *f is Lipschitz on $\overline{B_{2a}(x_0)}$.*

Now choose $b > 0$ so that

(1) $b \leq \frac{a}{L}$.

(2) $b < \frac{1}{k}$.

Then for each $x \in \overline{B_a(x_0)}$ there exists a unique $\alpha_x: (-b, b) \rightarrow U$ such that

$$\begin{aligned}\alpha'_x(t) &= f(\alpha_x(t)) \\ \alpha_x(0) &= x.\end{aligned}$$

Proof. Let $M = \{\alpha: (a, b) \rightarrow \overline{B_{2a}(x_0)}: \alpha \text{ is continuous}\}$. We can make M into a metric space by defining

$$d(\alpha_1, \alpha_2) = \|\alpha_1 - \alpha_2\| = \sup_t \|\alpha_1(t) - \alpha_2(t)\|.$$

Now M becomes a complete non-empty metric space. Now fix $x \in \overline{B_a(x_0)}$. Define $S: M \rightarrow M$ by

$$(S\alpha)(t) = x + \int_0^t f(\alpha(u))du.$$

We can do this since f is continuous on $\overline{B_{2a}(x_0)}$, which means that is integrable. For any $t \in (-b, b)$ we have

$$\begin{aligned}|S\alpha(t) - x| &= \left| \int_0^t f(\alpha(u))du \right| \\ &< bL \\ &\leq a.\end{aligned}$$

Since $|x - x_0| \leq a$, it follows that $|S\alpha(t) - x_0| < 2a$, for all $t \in (-b, b)$, so $S\alpha(t) \in B_{2a}(x_0) \subset \overline{B_{2a}(x_0)}$ for $t \in (-b, b)$. Thus S is a mapping from M to

M . Now suppose $\alpha, \beta, \in M$. Then

$$\begin{aligned} \|S\alpha - S\beta\| &= \sup_t \left| \int_0^t f(\alpha(u)) - f(\beta(u)) du \right| \\ &< bK \sup_{-b < u < b} |\alpha(u) - \beta(u)| \\ &< \|\alpha - \beta\|. \end{aligned}$$

Therefore S is a contraction. So by the contraction mapping theorem S has a unique fixed point:

$$\alpha(t) = x + \int_0^t f(\alpha(u)) du.$$

We shall show that α is the unique map $\beta : (-b, b) \rightarrow U$ satisfying

$$\beta(t) = x + \int_0^t f(\beta(u)) du.$$

We claim that the image of β actually lies in $B_{2a}(x_0)$. We already know that for each $0 \leq t < b$,

$$\beta(t) = x + \int_0^t f(\beta(u)) du$$

is in $B_{2a}(x_0)$ provided $\beta(u) \in \overline{B_{2a}(x_0)}$ for all u with $0 \leq u < t$, so certainly if $\beta(u) \in B_{2a}(x_0)$ for all u with $0 \leq u < t$. Now let

$$A = \{t : 0 \leq t < b \text{ and } \beta(u) \in B_{2a}(x_0) \text{ for } 0 \leq u < t\}.$$

Let $\alpha = \sup A$. Suppose that $\alpha < b$. $\beta(u) \in B_{2a}(x_0)$ for $0 \leq u < t$, therefore $\beta(\alpha) \in B_{2a}(x_0)$. This implies $\beta(\alpha + \epsilon) \in B_{2a}(x_0)$ for $\epsilon > 0$ sufficiently small, which contradicts the fact that α is the supremum. Hence $\sup A = b$. A similar argument works for $-b < u \leq 0$. \square

The local flow generated by the vector field f is

$$\alpha : (-b, b) \times \overline{B_a(x_0)} \rightarrow U,$$

where $\alpha|_{(-b,b) \times \{x\}}$ is the integral curve. The fact that α is continuous follows from the main theorem. If f is smooth, then α is smooth, although this is not so easy to show.

Global solutions? When are integral curves defined on $(-\infty, \infty)$.

(1) If the manifold is \mathbb{R}^n and if f is both bounded and Lipschitz, then integral curves are defined on $(-\infty, \infty)$. On an arbitrary manifold we require f to be both compactly supported and smooth.

Theorem 9.2.3. *Let X be a smooth vector field on M , and let $p \in M$. Then there is an open set V containing p and an $\epsilon > 0$, such that there is a unique collection of diffeomorphisms $\phi_t: V \rightarrow \phi_t(V) \subset M$ defined for $|t| < \epsilon$ with the following properties:*

- (1) $\phi: (-\epsilon, \epsilon) \times V \rightarrow M$, defined by $\phi(t, q) = \phi_t(q)$, is smooth.
- (2) If $|s|, |t|, |s + t| < \epsilon$, and $q, \phi_t(q) \in V$, then $\phi_{s+t}(q) = \phi_s \circ \phi_t(q)$.
- (3) If $q \in V$, then X_q is the tangent vector at $t = 0$ of the curve $t \rightarrow \phi_t(q)$.

The unique collection of local diffeomorphisms is called a local one parameter group of local diffeomorphisms.

Definition 9.2.2 (One Parameter Group of Diffeomorphisms). A one parameter family of maps $\{\phi_t\}_{t \in \mathbb{R}}$ is said to be a one parameter group of diffeomorphisms if:

- (1) Each $\phi_t: M \rightarrow M$ is a diffeomorphism.
- (2) $\phi_0 = id$.
- (3) $\phi_{s+t} = \phi_s \circ \phi_t$ for all $s, t \in \mathbb{R}$.

In other words we have a group action of \mathbb{R} on M . This is also called a *global flow* on M . If we have a global flow on M then we have a map $\mathbb{R} \rightarrow \text{Diff}(M)$ given by $t \rightarrow \phi_t$.

Example 9.2.5. Let $M = \mathbb{R}^3$. Then $\{\phi_t(x_1, x_2, x_3) = (x_1 + t, x_2, x_3)\}$ is a one parameter group of diffeomorphisms.

Given a one parameter family of diffeomorphisms $\{\phi_t\}$ we define a vector field as follows: For every smooth function f let

$$X_p(f) = \lim_{h \rightarrow 0} \frac{f(\phi_h(p)) - f(p)}{h}.$$

This vector field is said to generate the group $\{\phi_t\}$, and it is called the infinitesimal generator of $\{\phi_t\}$.

Example 9.2.6. Let $\{\phi_t\}$ be the one parameter family of diffeomorphisms

as in the previous example. Then

$$\begin{aligned} X_{(x_1, x_2, x_3)}(f) &= \lim_{h \rightarrow 0} \frac{f(\phi_h(x_1, x_2, x_3)) - f(x_1, x_2, x_3)}{h} \\ &= \lim_{h \rightarrow 0} \frac{f(x_1 + h, x_2, x_3) - f(x_1, x_2, x_3)}{h} \\ &= \frac{\partial f}{\partial x_1}. \end{aligned}$$

Therefore the infinitesimal generator for $\{\phi_t\}$ is the vector field $\frac{\partial}{\partial x_1}$.

The *support* of a vector field is defined to be

$$\overline{\{p \in M : X_p \neq 0\}}.$$

Theorem 9.2.4. *Let X be a compactly supported vector field on M . Then X generates a unique one parameter group of diffeomorphisms.*

Proof. For each p in the support of X we have an open set and a collection of diffeomorphisms defined for $|t| < \epsilon$. Since X has compact support it can be covered by finitely many open sets V_1, \dots, V_n , with the property that for each V_i there is collection of diffeomorphisms ϕ_t^i defined for ϵ_i . Now let $\epsilon = \min(\epsilon_1, \dots, \epsilon_n)$. By uniqueness we have $\phi_t^i(q) = \phi_t^j(q)$ for $q \in V_i \cap V_j$, hence the function

$$\phi_t(q) = \begin{cases} \phi_t^i(q) & \text{if } q \in V_i, \\ q & \text{if } q \notin \text{support of } X \end{cases}$$

is well-defined for $|t| < \epsilon$. Now we have to define ϕ_t for $|t| \geq \epsilon$. If $|t| \geq \epsilon$, then we can write t in the form

$$t = k \left(\frac{\epsilon}{2} \right) + r \quad \text{with } k \text{ an integer, and } r < \frac{\epsilon}{2}.$$

Let

$$\phi_t = \begin{cases} \phi_{\epsilon/2} \circ \dots \circ \phi_{\epsilon/2} \circ \phi_r & [\phi_{\epsilon/2} \text{ iterated } k \text{ times}] \quad \text{for } k \geq 0, \\ \phi_{-\epsilon/2} \circ \dots \circ \phi_{-\epsilon/2} \circ \phi_r & [\phi_{-\epsilon/2} \text{ iterated } -k \text{ times}] \quad \text{for } k < 0. \end{cases}$$

One can check that the the family of diffeomorphisms $\{\phi_t\}$ is indeed a one parameter group of diffeomorphisms. \square

Definition 9.2.3. A vector field on M is said to be *complete* if it generates a one parameter group of diffeomorphisms on M .

Corollary 9.2.1. Any vector field on a compact manifold is complete.

Example 9.2.7. Let $M = (0,1)$. Then the vector field $v = \frac{\partial}{\partial x}$ is not complete.

Lemma 9.2.1 (Isotopy Lemma). Any connected manifold M is homogeneous, i.e., for any $x, y \in M$ there exists a diffeomorphism $\phi: M \rightarrow M$ taking x to y . Moreover, the diffeomorphism ϕ is isotopic to the identity and is the identity outside a compact set.

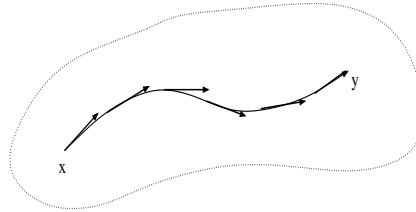

Proof. Let $x, y \in M$, and let $\gamma(t)$ be a smooth path from x to y . We can find a vector field X such that X vanishes outside of some compact set K , which contains x, y and the image of γ , and such that X restricted to γ is γ' . We then obtain a unique one parameter family of diffeomorphisms $\{\phi_t\}$. Let t denote the time it takes to flow from x to y . Then ϕ_t is a diffeomorphism taking x to y . \square

Corollary 9.2.2. Let M be a connected manifold of dimension strictly greater than one. Let $\{y_1, \dots, y_n\}$ and $\{z_1, \dots, z_n\}$ be two sets of distinct points on M . Then there exists a diffeomorphism $\phi: M \rightarrow M$ such that $\phi(y_i) = z_i$. Moreover, ϕ is isotopic to the identity and is the identity outside some compact set.

Theorem 9.2.5. If X is a smooth vector field on M and $X_p \neq 0$, then $X = \frac{\partial}{\partial x_1}$ in appropriate local coordinates around p .

Proof. We may assume $p = 0$ and that $X_0 = \frac{\partial}{\partial x_1} \Big|_0$.

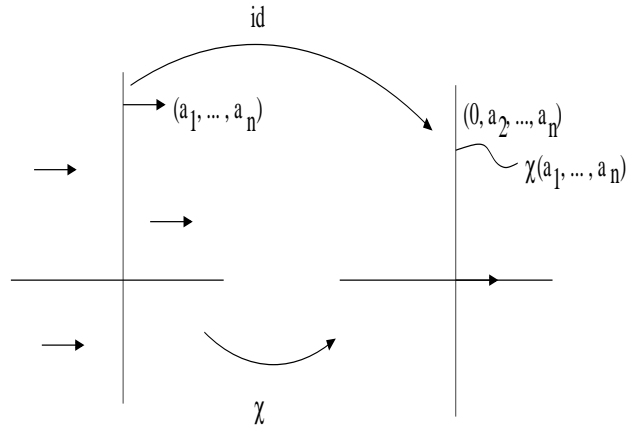

Define the function χ by $\chi(a_1, a_2, \dots, a_n) = \phi_{a_1}(0, a_2, \dots, a_n)$, where $\{\phi_t\}$ is the local flow generated by X . One can easily verify that $d\chi_0 = I$, which implies χ is a local diffeomorphism. Thus, χ^{-1} takes X to $\frac{\partial}{\partial x_1}$. \square

9.3 Lie Derivatives

Definition 9.3.1. Let X be a vector field on M , and Y another vector field on M . We want to define an operator which tells us how much Y is changing with respect to X . To do this we define another vector field on M called the Lie derivative. Let $\{\phi_t\}$ be the local flow generated by X . One might guess that we should define the Lie derivative to be

$$(L_X Y)(p) = \lim_{h \rightarrow 0} \frac{Y_p - (Y_{\phi_{-h}(p)})}{h},$$

but this does not make sense since the two vectors Y_p and $Y_{\phi_{-h}(p)}$ live in different tangent spaces. We get around this by pushing the vector $Y_{\phi_{-h}(p)}$ forward so that it lives in the same tangent space as Y_p .

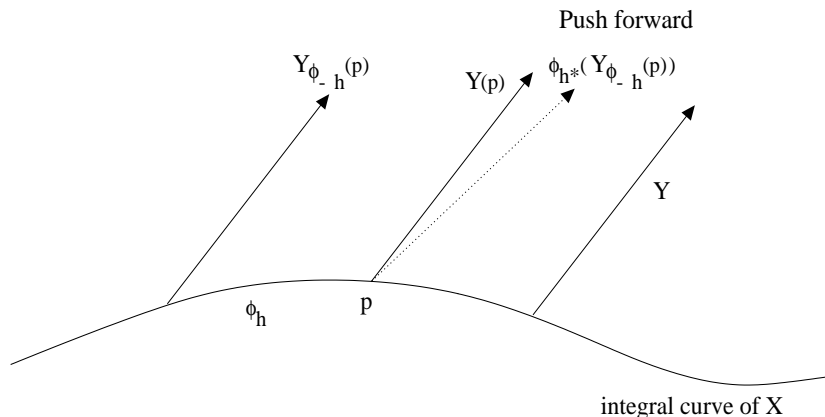

The vector $(\phi_h)_*(Y_{\phi_{-h}(p)}) = d\phi_h(Y_{\phi_{-h}(p)})$ does live in $T_p(M)$, therefore we define the *Lie derivative* to be

$$(L_X Y)(p) := \lim_{h \rightarrow 0} \frac{Y_p - (\phi_h)_*(Y_{\phi_{-h}(p)})}{h}.$$

Let $\alpha: M \rightarrow N$ be a diffeomorphism and X a vector field on M . We would like to push this vector field forward to get a vector field $\alpha_*(X)$ on N . To do this we define $\alpha_*(X)$ to be

$$(\alpha_* X)_q(f) := X_{\alpha^{-1}(q)}(f \circ \alpha).$$

Proposition 9.3.1. *Let $f: (-\epsilon, \epsilon) \times M \rightarrow \mathbb{R}$ be a smooth function so that $f(0, p) = 0$ for all $p \in M$. Then there exists a smooth function $g: (-\epsilon, \epsilon) \times M \rightarrow \mathbb{R}$ such that*

$$\begin{aligned} f(t, p) &= tg(t, p), \\ \frac{\partial f}{\partial t}(0, p) &= g(0, p). \end{aligned}$$

Theorem 9.3.1. *The Lie derivative is equal to the Lie bracket.*

Proof. Let $\{\phi_t\}$ be a local flow generated by X , and let $f: M \rightarrow \mathbb{R}$ be a smooth function. Let $\{g_t\}$ be the family of smooth functions such that

$$\begin{aligned} f \circ \phi_t - f &= tg_t \\ g_0 &= L_X f = X(f). \end{aligned}$$

Then

$$\begin{aligned} (\phi_h)_*(Y)(f) &= Y_{\phi_{-h}(p)}(f \circ \phi_h) \\ &= Y_{\phi_{-h}(p)}(f + hg_h). \end{aligned}$$

So by definition we have

$$\begin{aligned} (L_X Y)(f) &= \lim_{h \rightarrow 0} \frac{1}{h} (Y_p - ((\phi_h)_* Y)_p)(f) \\ &= \lim_{h \rightarrow 0} \frac{1}{h} ((Yf)(p) - (Yf)(\phi_h(p)) - \lim_{h \rightarrow 0} (Y_{g_h})(\phi_{-h}(p))) \\ &= L_X(Yf) - Y_{g_0}(p) \\ &= X_p(Yf) - Y_p(Xf) \\ &= [X, Y]_p(f). \end{aligned}$$

□

Lemma 9.3.1. *Let $\alpha: M \rightarrow N$ be a diffeomorphism, and let X a vector field on M , which generates $\{\phi_t\}$. Then the flow generated by α_*X is $\{\alpha \circ \phi_t \circ \alpha^{-1}\}$.*

Proof. We have

$$\begin{aligned} (\alpha_*X)_q(f) &= X_{\alpha^{-1}(q)}(f \circ \alpha) \\ &= \lim_{h \rightarrow 0} \frac{1}{h} [(f \circ \alpha)(\phi_h(\alpha^{-1}(q))) - (f \circ \alpha)(\alpha^{-1}(q))] \\ &= \lim_{h \rightarrow 0} \frac{1}{h} [f(\alpha \circ \phi_h \circ \alpha^{-1}(q)) - f(q)]. \end{aligned}$$

□

Corollary 9.3.1. *Let $\alpha: M \rightarrow M$ be a diffeomorphism. Then α commutes with all ϕ_t if, and only if, $\alpha_*X = X$.*

Lemma 9.3.2. *Let X and Y be vector fields on M , and let $\{\phi_t\}, \{\psi_s\}$ be the flows generated by X and Y respectively. Then $[X, Y] = 0$ if, and only if, $\phi_t \circ \psi_s = \psi_s \circ \phi_t$ for all s, t*

Proof. Let $\alpha = \psi_s$. Then by the previous corollary we have $(\psi_s)_*(X) = X$, which implies $L_Y X = 0$. Hence $[Y, X] = -[X, Y] = 0$. Conversely, suppose that $[X, Y] = 0$, so that the Lie derivative is zero. Let $p \in M$. Then the curve $c(t) := ((\phi_t)_*Y)_p$ has derivative zero. Hence $c(t)$ is a constant. The constant is Y , which implies $((\phi_t)_*Y) = Y$. Now by the previous corollary we have $\phi_t \psi_s = \psi_s \phi_t$. □

Theorem 9.3.2. *Let X and Y be vector fields with X_p and Y_p linearly independent. If $[X, Y] = 0$, then in appropriate local coordinates $X = \frac{\partial}{\partial x_1}$ and $Y = \frac{\partial}{\partial x_2}$.*

Proof. We can assume $X_p = \frac{\partial}{\partial x_1}$ and $Y_p = \frac{\partial}{\partial x_2}$ from linear independence. We now define the function χ by $\chi(a_1, a_2, \dots, a_n) = \phi_{a_1} \psi_{a_2}(0, 0, a_3, \dots, a_n)$, where ϕ is the flow generated by X and ψ is the flow generated by Y . We have $\chi(a_1, a_2, \dots, a_n) = \phi_{a_1} \psi_{a_2}(0, 0, a_3, \dots, a_n) = \psi_{a_2} \phi_{a_1}(0, 0, a_3, \dots, a_n)$. Thus χ^{-1} takes X to $\frac{\partial}{\partial x_1}$ and Y to $\frac{\partial}{\partial x_2}$. □

Theorem 9.3.3. *Let X_1, X_2, \dots, X_k be vector fields. If $X_1(p), X_2(p), \dots, X_k(p)$ are linearly independent and $[X_i, X_j] = 0$ for all i and j , then $X_i = \frac{\partial}{\partial x_i}$*

Exercises

1. Show that a connected n -manifold is parallelizable if, and only if, there exists n linearly independent vector fields on M .
2. Let M be a manifold. Show that $\Gamma(M)$ is a Lie algebra.
3. The *quaternion algebra* \mathbb{H} is the real vector space with basis $\{1, i, j, k\}$ with multiplication defined by the following rules:

$$i^2 = j^2 = k^2 = -1, \quad ij = k, \quad jk = i, \quad ki = j.$$

This algebra is non-commutative since $ji = -k$. It is associative, however. One can check that the quaternions form a division algebra. Thus the elements of norm 1 form a multiplicative subgroup whose elements comprise of the unit sphere S^3 . We say $p \in \mathbb{H}$ is imaginary if $p = xi + yj + zk$ for some $x, y, z \in \mathbb{R}$.

- (a) Show that if $p \in \mathbb{H}$ is imaginary, then qp is tangent to S^3 at each $q \in S^3$. (Here we identify each tangent space to \mathbb{H} with \mathbb{H} itself in the usual way).
- (b) Define vector fields X_1, X_2, X_3 on \mathbb{H} by

$$\begin{aligned} X_1(q) &= (q, qi) \\ X_2(q) &= (q, qj) \\ X_3(q) &= (q, qk) \end{aligned}$$

Show that these vector fields are linearly independent, and hence S^3 is parallelizable.

4. The algebra of *octonions* (also called *Cayley numbers*) is the 8-dimensional real vector space $\mathbb{O} = \mathbb{H} \times \mathbb{H}$ (where \mathbb{H} is the space of quaternions) with the following bilinear product:

$$(p, r)(r, s) = (pr - \bar{s}q, sp + q\bar{r}),$$

where $\bar{q} = q_1 - q_2i - q_3j - q_4k$ if $q = q_1 + q_2i + q_3j + q_4k$. Show that \mathbb{O} is a noncommutative, nonassociative algebra over \mathbb{R} , and prove that S^7 is parallelizable by imating as much as the previous problem as possible. Hint: It might be helpful to prove that $(P\bar{Q})Q = P(\bar{Q}Q)$ for all $P, Q \in \mathbb{O}$, where $\bar{Q} = (\bar{q}_1, -q_2)$ if $Q = (q_1, q_2)$.

5. Show that the flow of the vector field defined on \mathbb{R}^n by

$$\sum_{i=1}^n x_i \frac{\partial}{\partial x_i}$$

is the group of dilations: $\theta_t(x) = e^t x$. Deduce from this result the Euler identity for homogeneous functions.

6. Show that the infinitesimal generator is indeed a vector field.

7. Compute the image under the map $x \rightarrow e^x$ of the vector field $\frac{\partial}{\partial x}$ on \mathbb{R} .

8. Let \mathbb{R} act on \mathbb{R}^2 in the following way:

$$x \rightarrow x \cos t + y \sin t, \quad y \rightarrow -x \sin t + y \cos t,$$

which give $\phi_t(x, y)$. Show that this is a globally defined group action of \mathbb{R} on \mathbb{R}^2 and find the infinitesimal generator. What are the orbits?

10 Morse Theory

Recall: If $f: \mathbb{R}^n \rightarrow \mathbb{R}$ is smooth, then the *Hessian* at a critical point p is the matrix

$$\left(\frac{\partial^2 f}{\partial x_i \partial x_j}(p) \right).$$

This matrix is symmetric since partials commute. We say p is a non-degenerate critical point if the determinant of the Hessian is nonzero.

Example 10.0.1. Define $f: \mathbb{R}^2 \rightarrow \mathbb{R}$ by $f(x, y) = x^2 y^2$. Then the set of critical points, all of which are degenerate, consists of the union of the x -axis and the y -axis.

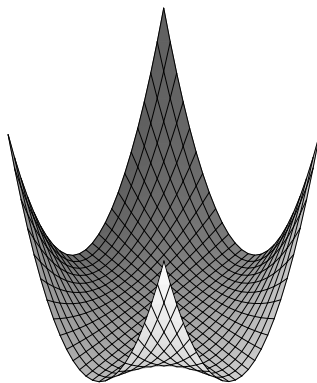

Example 10.0.2. Define $f: \mathbb{R}^2 \rightarrow \mathbb{R}$ by $f(x, y) = x^2 - y^2$. Then the origin is a non-degenerate critical point.

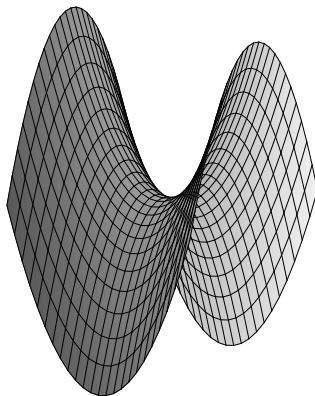

Example 10.0.3. Define $f: \mathbb{R}^2 \rightarrow \mathbb{R}$ by $f(x, y) = x^3 - 3xy^2$. Then the origin is a degenerate critical point.

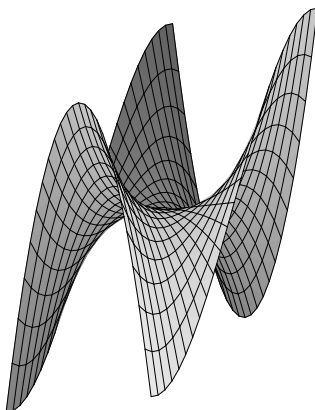

Definition 10.0.2. A function $f: \mathbb{R}^n \rightarrow \mathbb{R}$ is *Morse* if the Hessian at every critical point is non-degenerate.

Definition 10.0.3. Let $f: M \rightarrow \mathbb{R}$ be a smooth function and $p \in M$ a critical point. The Hessian of f at p is the symmetric bilinear form f_{**} on $T_p M$ defined by $f_{**}(v, w) = \bar{v}_p \bar{w}_p(f)$, where \bar{v} and \bar{w} are vector fields defined in a neighbourhood of p with $\bar{v}(p) = v$, $\bar{w}(p) = w$.

Lemma 10.0.3. *The definition above is well-defined.*

Proof. The definition is clearly independent of \bar{v} . Also, $\bar{v}_p \bar{w}(f) - \bar{w}_p \bar{v}(f) = [\bar{v}, \bar{w}]_p(f) = 0$, since p is a critical point. Therefore it is also independent of \bar{w} . \square

So the change of basis matrix is

$$\begin{pmatrix} 1 & 0 \\ 1 & \sqrt{2} \end{pmatrix}.$$

Our matrix with respect to this change of basis is

$$\begin{pmatrix} 1 & 0 \\ 0 & -1 \end{pmatrix}.$$

Hence the nullity is zero and the index is one.

If A is the matrix of the form and M is the change of basis matrix, then the matrix of the bilinear form with respect to this change of basis is $M^T A M$.

Definition 10.0.4. A function $f: M \rightarrow \mathbb{R}$ is a Morse function if the Hessian at every critical point is non-degenerate.

Example 10.0.6. We shall show that the function $f: S^n \rightarrow \mathbb{R}$ given by $f(x_1, \dots, x_{n+1}) = x_{n+1}$ is a Morse function. The only critical points of f are the north and south poles. Now around $x = (0, \dots, 0, 1)$ we have the local parametrisation $\phi: B(1) \rightarrow \mathbb{R}^{n+1}$ given by

$$\phi(x_1, x_2, \dots, x_n) = \left(x_1, x_2, \dots, \sqrt{1 - \sum_{i=1}^n x_i^2} \right).$$

Thus, $f \circ \phi: B(1) \rightarrow \mathbb{R}$ is given by $(x_1, \dots, x_n) \rightarrow (1 - x_1^2 - x_2^2 - \dots - x_n^2)^{1/2}$. We leave the reader to verify that the Hessian at the north pole is:

$$\begin{pmatrix} -1 & & \\ & \ddots & \\ & & -1 \end{pmatrix},$$

where the number of -1's is n . The Hessian matrix at the north pole is clearly nonsingular. The index at the north pole is n . Now consider the south pole $y = (0, \dots, 0, -1)$. Around y we have the local parametrisation $\phi: B(1) \rightarrow \mathbb{R}^{n+1}$ given by

$$\phi(x_1, x_2, \dots, x_n) = \left(x_1, x_2, \dots, -\sqrt{1 - \sum_{i=1}^n x_i^2} \right).$$

Thus, $f \circ \phi: B(1) \rightarrow \mathbb{R}$ is given by $(x_1, \dots, x_n) \rightarrow -(1 - x_1^2 - x_2^2 - \dots - x_n^2)^{1/2}$. Again, we leave the reader to verify that the Hessian at the south pole is:

$$\begin{pmatrix} 1 & & \\ & \ddots & \\ & & 1 \end{pmatrix},$$

where the number of 1's is n . The Hessian matrix at the south pole is clearly nonsingular, and the index at the south pole is 0.

Lemma 10.0.4 (Morse lemma). *Suppose that $p \in M$ is a non-degenerate critical point of a function $f: M \rightarrow \mathbb{R}$ of index λ . Then in suitable local coordinates around p , f has the form $f = f(p) - x_1^2 - x_2^2 - \dots - x_\lambda^2 + x_{\lambda+1}^2 + \dots + x_n^2$.*

Example 10.0.7. Let $f: \mathbb{R}^2 \rightarrow \mathbb{R}$ be given by $f(x, y) = xy$. The Hessian of this function is

$$\begin{pmatrix} 0 & 1 \\ 1 & 0 \end{pmatrix}.$$

Therefore this function is a Morse function. Now let $x = X - Y$ and $y = X + Y$. Then in these new coordinates f takes the form $f(X, Y) = X^2 - Y^2$.

Lemma 10.0.5. *A function $f: \mathbb{R}^n \rightarrow \mathbb{R}$ is Morse if, and only if, $df: \mathbb{R}^n \rightarrow \mathbb{R}^n$ given by $df = (\frac{\partial f}{\partial x_1}, \dots, \frac{\partial f}{\partial x_n})$ is transverse to $\{0\}$.*

Proof. The derivative of df is the Hessian and $df(x) = 0$ if, and only if, x is a critical point for f . Hence df is a submersion if, and only if, $(\frac{\partial^2 f}{\partial x_i \partial x_j})$ is non-singular. \square

Theorem 10.0.4. *Let $f: \mathbb{R}^n \rightarrow \mathbb{R}$ be a smooth function. Then for almost all $a \in \mathbb{R}^n$, the function $f_a: \mathbb{R}^n \rightarrow \mathbb{R}$ given by $f_a(x) = f(x) - a \cdot x$ is a Morse function.*

Proof. The function f_a is Morse if, and only if, $df_a = df - a \lrcorner \{0\}$. Hence f_a is Morse if, and only if, $df \lrcorner \{a\}$ and by Sard's theorem this holds for almost all a . \square

If $f: M \rightarrow \mathbb{R}$ is smooth, then the total derivative $df: M \rightarrow T^*M$, given by $df(x)(v) = df_x(v)$, is a smooth section of $\pi: T^*M \rightarrow M$.

Theorem 10.0.5. *A smooth function $f: M \rightarrow \mathbb{R}$ is Morse if, and only if, $df: M \rightarrow T^*M$ is transverse to the zero section.*

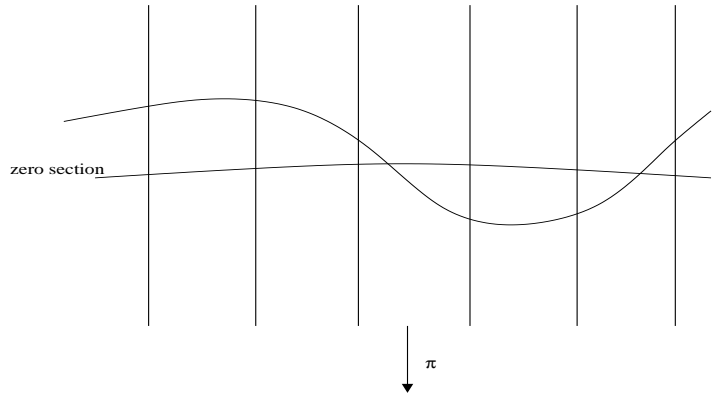

Theorem 10.0.6. *Let $f: M \rightarrow \mathbb{R}$ be a smooth function. Then for almost all $a \in \mathbb{R}^n$ the function $f_a: M \rightarrow \mathbb{R}$ given by $f_a(x) = f(x) - a \cdot x$ is a Morse function.*

Proof. Define $H: M \times \mathbb{R}^n \rightarrow T^*M$ by $H(x, a) = df_a(x)$. Then H is transverse to the zero section. Therefore df_a is transverse to the zero section for almost all $a \in \mathbb{R}^n$, hence f_a is Morse. \square

Corollary 10.0.2. *Let M be a manifold. Then there exists a Morse function $f: M \rightarrow \mathbb{R}$.*

Lemma 10.0.6. *Let X be a compact manifold, and let $f: X \rightarrow \mathbb{R}$ be a Morse function. Then there exists a Morse function $g: X \rightarrow \mathbb{R}$ with distinct critical values. Moreover, the function g can be made arbitrarily close to f .*

Proof. From the one of the exercises it follows that f has finitely many critical points. Let x_1, \dots, x_n be the critical points. Now let ρ_i be a function that is one on a small neighbourhood of x_i and zero outside a slightly larger neighbourhood (we require that x_i is the only critical point in the neighbourhood). Now choose a_1, \dots, a_n such that

$$f(x_i) + a_i \neq f(x_j) + a_j \quad \text{if } i \neq j.$$

The function

$$g(x) = f(x) + \sum_{i=1}^n a_i \rho_i.$$

is the desired function. By choosing the a_i 's arbitrarily small we can make g arbitrarily close to f . \square

Exercises

1. Let $f: M \rightarrow \mathbb{R}$ be a smooth function. Show that the non-degenerate critical points of f are isolated.
2. Let $f: M \rightarrow \mathbb{R}$ be a Morse function on a compact manifold. Show that the number of critical points of f is finite.
3. Let $f_m: S^m \rightarrow \mathbb{R}$ and $f_n: S^n \rightarrow \mathbb{R}$ be the height functions in example 85. Let A and B be real numbers such that $1 < A < B$. Show that the function

$$f = (A + f_m)(B + f_n): S^m \times S^n \rightarrow \mathbb{R}$$

is a Morse function.

4. Let $M(2)$ denote the set of 2×2 matrices over \mathbb{R} . Show that the determinant function is a Morse function.
5. We saw earlier that $T^2 = \{(x, y, z) \in \mathbb{R}^3 : z^2 = 1 - (\sqrt{x^2 + y^2} - a)^2\}$. Show that the function $f: T^2 \rightarrow \mathbb{R}$ given by $f(x, y, z) = y$ is a Morse function.
6. Define $f: \mathbb{R}P^2 \rightarrow \mathbb{R}$ by

$$f([x : y : z]) = \frac{x^2 + 2y^2}{x^2 + y^2 + z^2}$$

Compute the critical points of f . Show that f is a Morse function and compute the Morse index of each critical point. (Hint: Work in local coordinates, in the standard charts U_0, U_1, U_2 , where $U_0 = \{x \neq 0\}$, etc.)

11 Manifolds with Boundary

Let $H^k = \{(x_1, \dots, x_k) \in \mathbb{R}^k : x_k \geq 0\}$ denote upper half-space.

Definition 11.0.5. A subset X of \mathbb{R}^n is a n -dimensional manifold with boundary if it is locally diffeomorphic to H^n , that is, at each point $x \in X$, there exists a neighbourhood which is diffeomorphic to H^n . We denote the boundary of X by ∂X and it consists of those points which are in the image of the boundary of H^n under some local parametrisation.

Example 11.0.8. $S^1 \times I$ is a manifold with boundary.

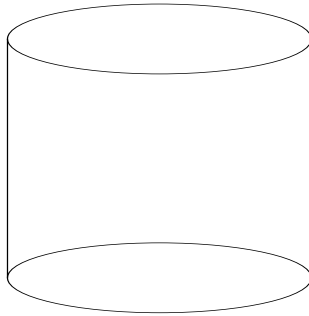

Example 11.0.9. The Möbius band is an example of a manifold with boundary.

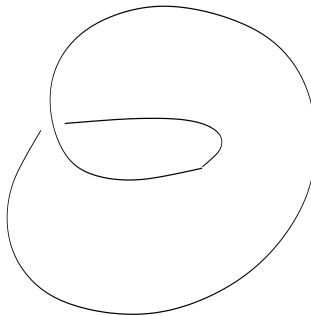

Example 11.0.10. Let M_g denote a surface of genus g . M_g bounds a compact region in \mathbb{R}^3 and this compact region is called a *handle body*, it is a three manifold with boundary M_g .

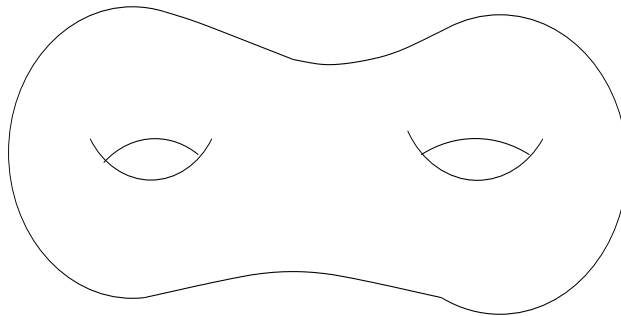

Example 11.0.11. Let K be a knot in S^3 . Take a closed tubular neighbourhood of K in S^3 . Now remove the interior of the tubular neighbourhood. What you are left with is a 3-manifold with a torus as a boundary.

Proposition 11.0.2. Let M be a n -dimensional manifold with boundary. Then ∂M is a $(n - 1)$ -dimensional manifold without boundary.

Proof. Let $x \in \partial M$. Then there is a local parametrisation $\phi: U \rightarrow V$, where U is an open set of H^n and V is an open set of V .

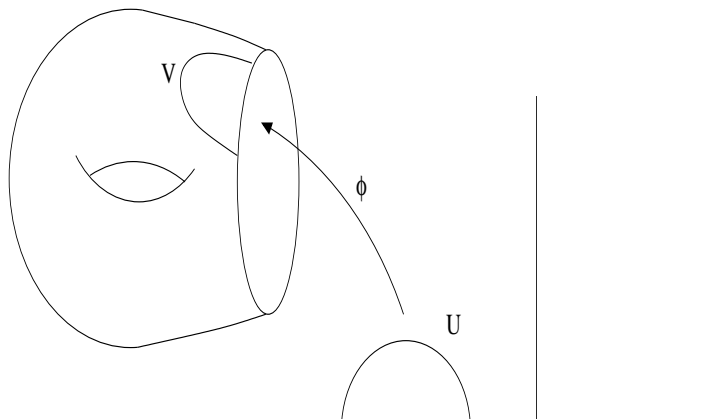

If we can show that $\phi(\partial U) = \partial V$, then we are done. For $\phi|_{\partial U}: \partial U \rightarrow V \cap \partial M$ is a local parametrisation for $x \in \partial M$. Now by definition $\phi(\partial U) \subset \partial V$. To show $\phi(\partial U) \supset \partial V$ we need to show that if ψ is any local parametrisation mapping an open set W of H^n into V , then $\phi(\partial U) \supset \psi(\partial W)$. Let $f = \phi^{-1} \circ \psi: W \rightarrow U$ and suppose that some $w \in W$ maps to an interior point $u = f(w)$ of U . Now f is a diffeomorphism of W onto some open set $f(W) \subset U$. Now as usual, the chain rule implies $(d(f^{-1}))_u$ is bijective. The inverse function theorem tells us that there exists an open neighbourhood of u that maps onto an open neighbourhood of w . This contradicts the assumption that w maps to an interior point. \square

If $x \in \partial X$, then $T_x(\partial X)$ is a codimension 1 subspace of $T_x(X)$. For any smooth map $f: X \rightarrow Y$ we use the notation ∂f to mean f restricted to ∂X . The derivative of ∂f at x is just the restriction of df_x to $T_x(\partial X)$.

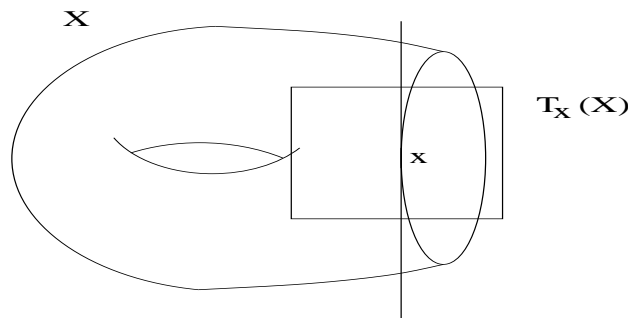

Lemma 11.0.7. Let X be a manifold without boundary, and let $f: X \rightarrow \mathbb{R}$ be a smooth function with t as a regular value. Then $f^{-1}((-\infty, t])$ is a manifold with boundary.

Example 11.0.12.

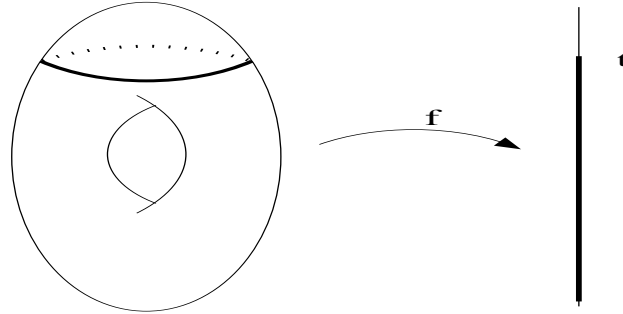

Example 11.0.13. Let $X = \mathbb{R}^n$. Define $f: X \rightarrow \mathbb{R}$ to be $f(x) = \|x\|^2 - 1$. Then $f^{-1}((-\infty, 0])$ is a manifold with boundary, and the boundary is the sphere S^{n-1} .

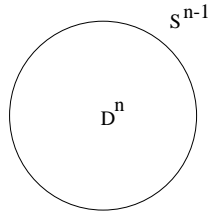

Theorem 11.0.7 (Sard's Theorem). Let X be a manifold with boundary, and let Y be a manifold without boundary. If $f: X \rightarrow Y$ is a smooth map, then almost every point $y \in Y$ is a regular value of both f and ∂f .

Proof. Now ∂f is just f restricted to ∂X . So the critical values for $\partial f: \partial X \rightarrow Y$ has measure zero. Let $X' = X - \partial X$, and let $f_{X'}$ be f restricted to X' . The critical values for $f_{X'}$ have measure zero. The union of the critical values for ∂f and $f_{X'}$ have measure zero. Therefore almost every point $y \in Y$ is a regular value of both f and ∂f . \square

Proposition 11.0.3. Let X be a manifold without boundary and Y a manifold with boundary. Then $X \times Y$ is a manifold with boundary, and $\partial(X \times Y) = X \times \partial Y$.

Let X be a manifold with boundary, and let $x \in \partial X$. Let $\phi: U \rightarrow X$ be a local parametrisation with $\phi(0) = x$. Then $d\phi_0: \mathbb{R}^k \rightarrow T_x(X)$ is an isomorphism by definition. The *upper half-space* $H_x(X)$ in $T_x(X)$ is defined to be the image of H^k . You can check that this definition is well-defined. There are precisely two unit vectors that are perpendicular to $T_x(\partial X)$. The one

that lies inside $H_x(X)$ is called the *inward unit normal* to the boundary, and the other is called the *outward unit normal*. Denote the outward unit normal by $\vec{n}(x)$.

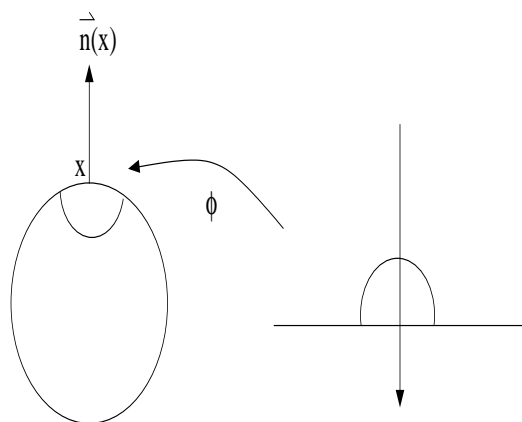

Transversality for a manifold with boundary. A map $f: X \rightarrow Y$ is transverse to $Z \subset Y$, if for all $x \in X$ such that $f(x) \in Z$ we have:

$$df_x(T_x(X)) + T_{f(x)}Z = T_{f(x)}(Y)$$

and $f|_{\partial X}$ is transverse to Z , that is, for all $x \in \partial X$ such that $f(x) \in Z$ we have:

$$d(f|_{\partial X})(T_x(\partial X)) + T_{f(x)}Z = T_{f(x)}Y.$$

If f is transverse to Z , then we say $f^{-1}(Z)$ is a neat submanifold.

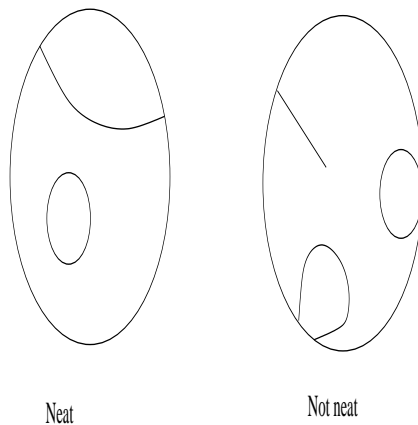

Theorem 11.0.8. Let $f: X \rightarrow Y$ be a smooth map between manifolds, we require Y to have no boundary. Suppose that both f and ∂f are transverse

to some boundaryless submanifold Z in Y . Then $f^{-1}(Z)$ is a manifold with boundary and

$$\partial\{f^{-1}(Z)\} = f^{-1}(Z) \cap \partial X.$$

Moreover, the codimension of $f^{-1}(Z)$ in X equals the codimension of Z in Y .

For the proof use: If M is a manifold without boundary and $f: M \rightarrow \mathbb{R}$ smooth with 0 as a regular value, then $f^{-1}[0, \infty)$ is a manifold with boundary and $\partial f^{-1}[0, \infty) = f^{-1}(0)$.

Theorem 11.0.9. *Let M be a compact, connected, non-empty one manifold. Then M is diffeomorphic to S^1 or $[0, 1]$.*

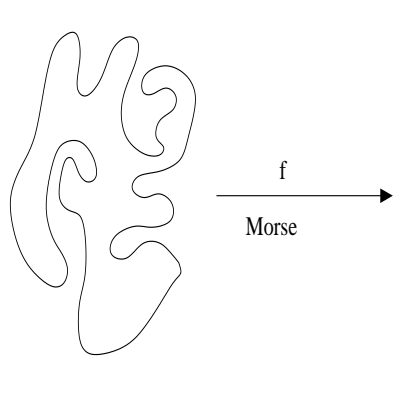

Proof. We shall only sketch the proof. The idea is to study $f^{-1}(-\infty, a] = M_a$. Since M is compact there are only finitely many critical points. The topology of M_a only changes when a passes through a critical value. If a is a critical value with $f(x_0) = a$, x_0 a critical point. Then $f^{-1}(-\infty, a + \epsilon]$ is obtained (up to diffeomorphism) from $f^{-1}(-\infty, a - \epsilon]$ by adding a disjoint arc (ϵ small enough so that $\epsilon + a$ and $a - \epsilon$ do not have any other critical points) if $index(x_0) = 0$, or by adding an arc along two endpoints, if $index(x_0) = 1$. \square

Theorem 11.0.10 (No Smooth Retraction Theorem). *If M is any compact manifold with boundary, then there is no smooth retraction $r: M \rightarrow \partial M$ with $r|_{\partial M} = id$.*

Proof. Pick $x \in \partial M$ so that x is a regular value of $r: M \rightarrow \partial M$. Note that x is a regular value of $r|_{\partial M}: \partial M \rightarrow \partial M$. Now $r^{-1}(x)$ is a neat submanifold

of dimension one and $\partial(r^{-1}(x)) = \{x\}$. But every compact one manifold has an even number of boundary points. \square

We can actually prove the no smooth retraction theorem, in the case $M = D^n$, with smooth replaced with continuous.

Proof. Suppose F is a continuous retraction. Applying the smooth approximation theorem to $F: D^n \rightarrow \partial D^n \subset \mathbb{R}^n$, with $\epsilon = 1/10$, we obtain a smooth function $g: D^n \rightarrow \mathbb{R}^n$ which is close to F .

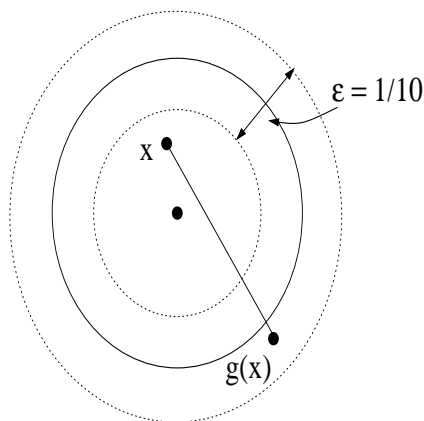

Let $x \in D^n$. Then x can be written in polar coordinates (r, θ) , where $r \in [0, 1]$ and $\theta \in [0, 2\pi)$. We now define a smooth map $h: D^n \rightarrow \partial D^n \subset \mathbb{R}^n$ by $h(r, \theta) = R(\alpha(r)x + (1 - \alpha(r))g(x))$, where $R: \mathbb{R}^n - \{0\} \rightarrow \partial D^n$ is the radial projection and $\alpha: [0, 1] \rightarrow [0, 1]$ is a smooth map which is zero for all $x < \delta$ (δ is to be chosen).

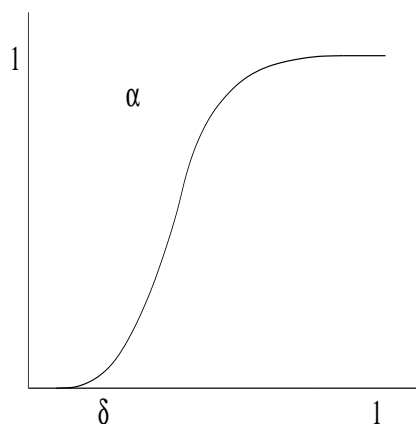

We need to make sure $(\alpha(r)x + (1 - \alpha(r))g(x)) \neq 0$ because it is not in the domain of R . So we choose δ so that if $r > \delta$, then the line segment joining

x to $g(x)$ does not contain the origin. Since $\alpha(1) = 1$, $h: D^n \rightarrow \partial D^n$ is a smooth retraction with $h|_{\partial D^n} = id$. \square

Remark: The same argument can be used to prove the following: Suppose M is a compact manifold with boundary which admits a neighbourhood U of ∂M and a smooth retraction $R: U \rightarrow \partial M$. Then there is no continuous retraction $r: M \rightarrow \partial M$.

Theorem 11.0.11 (Brouwer's Fixed Point Theorem). *Every continuous function $f: D^n \rightarrow D^n$ has a fixed point.*

Proof. Suppose that f has no fixed point. Then define $r: D^n \rightarrow \partial D^n$ via the following diagram.

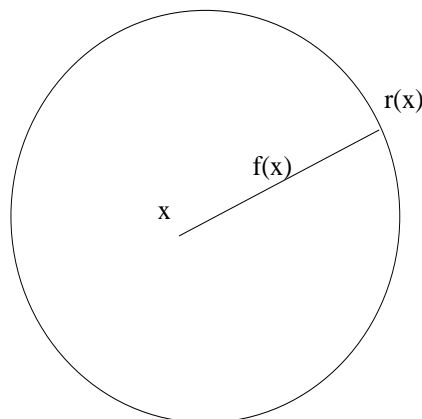

Then r is a continuous retraction from D^n to S^{n-1} , which is a contradiction. \square

Corollary 11.0.3. *Every continuous function $f: D \rightarrow D$, where D is homeomorphic to D^n , has a fixed point.*

Take two sheets of paper, one lying directly above the other. If you crumple the top sheet, and place it on top of the other sheet, then Brouwer's theorem says that there must be at least one point on the top sheet that is directly above the corresponding point on the bottom sheet! Do you believe that? In dimension three, Brouwer's theorem says that if you take a cup of coffee, and slosh it around, then after the sloshing there must be some point in the coffee which is in the exact spot that it was before you did the sloshing (though it might have moved around in between). Moreover, if you tried to

slosh that point out of its original position, you can't help but slosh another point back into its original position!

Exercises

1. Show that Brouwer's fixed point theorem does not hold for the torus.
2. Prove corollary 4.
3. Let A be an $n \times n$ matrix with nonnegative entries. Then A has a real nonnegative eigenvalue. Hint: You can assume that A is nonsingular; otherwise 0 is an eigenvalue. Now consider map $S^{n-1} \rightarrow S^{n-1}$ given by $x \rightarrow \frac{Ax}{|Ax|}$. Now what can you say about this map restricted to the first quadrant

$$\{(x_1, \dots, x_n) \in S^{n-1} : x_i \geq 0\}.$$

12 Riemannian Geometry

Definition 12.0.6 (Riemannian Manifold). A *Riemannian Manifold* is a smooth manifold M together with a choice of an inner product \langle, \rangle_p in each $T_p M$ satisfying: If X and Y are two smooth vector fields (smooth sections of TM) then the function $M \rightarrow \mathbb{R}$ given by $p \rightarrow \langle X(p), Y(p) \rangle_p = g(X, Y)_p$, is smooth. We shall denote this Riemannian manifold with the pair (M, g) . The function g is called the Riemannian metric.

Example 12.0.14. The smooth manifold \mathbb{R}^n with the standard inner product at each tangent space is a Riemannian manifold. For if X and Y are smooth vector fields on \mathbb{R}^n , then

$$X = \sum_{i=1}^n a_i \frac{\partial}{\partial x_i} \quad \text{and} \quad Y = \sum_{i=1}^n b_i \frac{\partial}{\partial x_i}.$$

Therefore the function $p \rightarrow \langle X(p), Y(p) \rangle_p$ is given by $p \rightarrow \sum_{i=1}^n a_i b_i(p)$, which is smooth.

Definition 12.0.7 (Induced metric). Let $f: M \rightarrow N$ be an immersion and (N, \tilde{g}) a Riemannian manifold. Then

$$g(X, Y) := \tilde{g}(df_p(X), df_p(Y))_{f(p)}$$

defines the *induced* (or *pullback*) Riemannian metric on M .

Definition 12.0.8. Let $\gamma: (a, b) \rightarrow M$ be a curve, then the length of γ is defined to be

$$l(\gamma) := \int_a^b \|\gamma'(t)\| dt,$$

where $\|\cdot\|$ is the induced norm of the inner product.

We can now make a Riemannian manifold into a metric space, provided the manifold is connected.

Theorem 12.0.12. Let (M, g) be a connected Riemannian manifold. Let $x, y \in M$. Then

$$d_M(x, y) := \inf\{l(\gamma) : \gamma \text{ is curve joining } x \text{ to } y\}$$

defines a metric on M .

Proof. The only non-trivial thing to check is that if $p \neq q$, then $d(p, q) > 0$. To prove this we may assume that p and q lie in some coordinate neighbourhood. Let $v \in T_p M$, then v can be written in the form

$$v = \sum_{i=1}^n a_i \frac{\partial}{\partial x_i}.$$

Now the $[g_{ij}]$ matrix is a symmetric matrix and so we may choose an orthonormal basis e_1, \dots, e_n such that each e_i is an eigenvector. Then

$$v = \sum_{i=1}^n c_i e_i.$$

We have

$$\begin{aligned} \langle v, v \rangle_g &= v^T [g_{ij}] v \\ &= \left\langle \sum_{i=1}^n n c_i e_i, \sum_{i=1}^n n \lambda_i c_i e_i \right\rangle \\ &= \sum_{i=1}^n c_i^2 \lambda_i \\ &\geq \lambda \sum_{i=1}^n c_i^2, \end{aligned}$$

where λ is the smallest eigenvalue. Now the Euclidean norm of v is $\sum_{i=1}^n c_i^2$. The smallest eigenvalue of the $[g_{ij}]$ varies continuously and hence will have a minimum on a compact region. Thus the Riemannian length of any curve from p to q is greater, than the Euclidean length of the curve. \square

Definition 12.0.9. Let M be a Riemannian manifold. A curve $\gamma: (a, b) \rightarrow M$ is a *geodesic* if:

(1) γ has constant speed.

(2) γ is locally distance minimizing, i.e., for all $t \in (a, b)$ there exists an $\epsilon > 0$ such that $d_M(\gamma(x), \gamma(y)) = l(\gamma|_{[x,y]})$ for all $x, y \in (t - \epsilon, t + \epsilon)$.

Theorem 12.0.13 (Fundamental Theorem of Riemannian Geometry). *Let M be a Riemannian manifold. Then for any $x \in M$ and any $v \in T_x M$ there is a geodesic $\gamma: (-\epsilon, \epsilon) \rightarrow M$ such that $\gamma(0) = x$ and $\gamma'(0) = v$. Moreover, if ψ is another such curve, then $\gamma = \psi$ wherever they are both defined.*

Example 12.0.15. \mathbb{R}^n with the standard inner product at each $T_x(\mathbb{R}^n)$ is a Riemannian manifold, and the geodesics are straight lines.

Example 12.0.16. Let M be a submanifold of \mathbb{R}^n . Then $T_x(M) \subseteq \mathbb{R}^n$, and if we give $T_x(M)$ the induced inner product, then M becomes a Riemannian manifold. For example, the sphere S^n with the induced metric from \mathbb{R}^{n+1} is a Riemannian manifold.

Example 12.0.17. Let $T^2 = \mathbb{R}^2/\mathbb{Z}^2$. Then we can identify $T_x(T^2)$ with \mathbb{R}^2 , then take the standard inner product. This gives us the Flat torus. You cannot isometrically embed the flat torus in three space. Try to make a flat torus with a piece of paper without crumbling the paper, you will find it impossible.

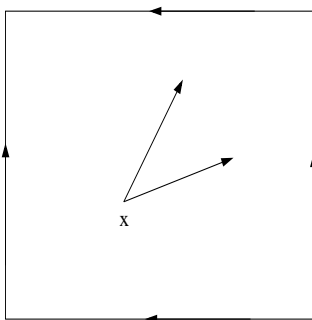

Can we view every Riemannian manifold as a submanifold of \mathbb{R}^n , where the inner product of the Riemannian manifold is just the induced inner product of \mathbb{R}^n ? The answer to this question is yes and it was proved by John Nash in 1956.

Theorem 12.0.14 (Nash Embedding Theorem). *Any Riemannian manifold M can be isometrically (and smoothly) embedded in some Euclidean space.*

Theorem 12.0.15. *Let M be a differentiable manifold. Then M has a Riemannian metric.*

Proof. The Whitney embedding theorem says that M embeds into \mathbb{R}^{2n+1} . Now give M the induced Riemannian metric. \square

Let M be a Riemannian manifold, and let $f: M \rightarrow \mathbb{R}$ be a smooth function. Then df_p is a linear functional on a Hilbert space. Therefore there exists a vector W such that $\langle X, W \rangle_p = df_p(X)$. Repeating this for each $p \in M$ we obtain a vector field, and we denote this by $\text{grad}(f)$, the gradient of f .

Definition 12.0.10. Two Riemannian manifolds (M, g) and (N, h) are *isometric* Riemannian manifolds if, and only if, there exists a diffeomorphism $f: M \rightarrow N$ such that $df_p: T_p M \rightarrow T_{f(p)} N$ is a vector space isometry for all $p \in M$.

Definition 12.0.11. If (M_1, g_1) and (M_2, g_2) are Riemannian manifolds then the product metric on $M_1 \times M_2$, $g = g_1 \oplus g_2$, is defined by

$$g(X_1 \oplus X_2, Y_1 \oplus Y_2)_{(p_1, p_2)} := g_1(X_1, Y_1)_{p_1} + g_2(X_2, Y_2)_{p_2}.$$

12.1 Connections

Definition 12.1.1. A *connection* on M is a map $\nabla: TM \times \Gamma(TM) \rightarrow TM$ (write $\nabla_\eta Y$ not $\nabla(\eta, Y)$.) such that $\nabla_\eta Y \in T_p M$ if $\eta \in T_p M$ and such that $X, Y \in \Gamma(TM)$ implies $\nabla_X Y \in \Gamma(TM)$.

(a) $\nabla_{\alpha\eta + \beta\zeta} Y = \alpha \nabla_\eta Y + \beta \nabla_\zeta Y$, where α and β are constants.

(b) $\nabla_\eta(Y_1 + Y_2) = \nabla_\eta Y_1 + \nabla_\eta Y_2$ (linearity in Y)

(c) $\nabla_\eta(fY) = \eta(f)Y + f \nabla_\eta Y$ (product rule)

Proposition 12.1.1. *Let M be a Riemannian manifold with a connection ∇ . Let $c: I \rightarrow M$ be a differentiable curve in M and let $V_0 \in T_{c(t_0)} M$. Then there exists a unique parallel vector field V along c , such that $V(t_0) = V_0$ ($V(t)$ is called the parallel transport of $V(t_0)$ along c).*

Definition 12.1.2. Let M be a Riemannian manifold. A connection ∇ on M is compatible with the metric if, and only if, for any vector fields V and W along the differentiable curve $c: I \rightarrow N$ we have

$$\frac{d}{dt} \langle V, W \rangle = \langle \frac{DV}{dt}, W \rangle + \langle V, \frac{DW}{dt} \rangle, \quad t \in I.$$

Thus we have a product rule for differentiating.

Example 12.1.1. \mathbb{R}^n with the standard connection is compatible with the Euclidean metric.

Proposition 12.1.2. A connection ∇ on M is compatible with the metric if, and only if,

$$X \langle Y, Z \rangle = \langle \nabla_X Y, Z \rangle + \langle Y, \nabla_X Z \rangle$$

for all vector fields X, Y and Z .

Just as a manifold has many Riemannian metrics it also has lots of connections. The ground level theorem of Riemannian geometry, however, is that given a Riemannian manifold (M, g) there is a unique connection (the Levi-Civita connection) which is compatible with the metric

$$(d) \quad X \langle Y, Z \rangle = \langle \nabla_X Y, Z \rangle + \langle Y, \nabla_X Z \rangle$$

$$(e) \quad \nabla_X Y - \nabla_Y X = [X, Y].$$

12.2 Collars

Theorem 12.2.1 (Collar Theorem). If M is a manifold with boundary, then ∂M has a neighbourhood in M diffeomorphic to $\partial M \times [0, 1)$

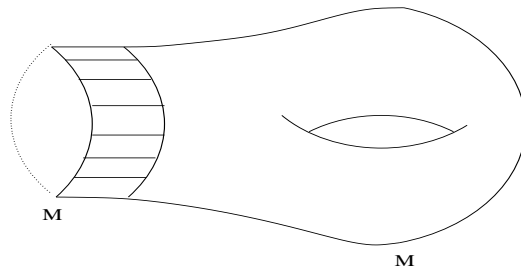

Corollary 12.2.1. Suppose that ∂M is compact and $\partial M = V_0 \cup V_1$, where V_0, V_1 are closed, disjoint subsets of M . Then there exists a smooth function $f: M \rightarrow [0, 1]$ such that $f^{-1}(0) = V_0$ and $f^{-1}(1) = V_1$.

Proof. Let $W = \partial M \times [0, 1)$ be a collar of M . Define $g: M \rightarrow [0, 1]$ by

$$g(p) = \begin{cases} t, & \text{if } p = (x, t) \in V_0 \times [0, 1/2] \\ 1 - t, & \text{if } p = (x, t) \in V_1 \times [0, 1/2] \\ 1/2, & \text{otherwise.} \end{cases}$$

It follows that g is continuous from the compactness of ∂M . Now, a smooth $1/4$ -approximation to g , agreeing with g on $\partial M \times [0, 1/2]$, is the desired function. \square

If M and N are two manifolds with boundary and $h: \partial M \rightarrow \partial N$ is a diffeomorphism, then we can construct a new manifold

$$W = M \sqcup N / \sim,$$

where $x \sim h(x)$. The charts in $M - \partial M$, $N - \partial N$ are the old charts.

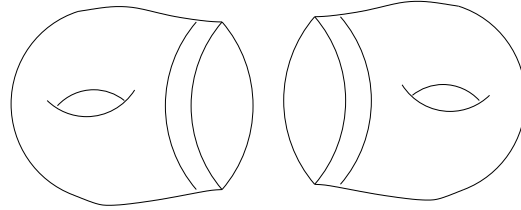

Using the collar theorem there is a neighbourhood of $\partial M \cong \partial N$ and a homeomorphism to $\partial M \times (-1, 1)$, which is a diffeomorphism to M and to N . We use these to generate charts.

A special case of this is when we take two copies of a manifold M and glue the boundary of M to itself via the identity map. The resulting manifold we shall denote $2M$, the double of M .

Remark: If we glue two discs D_1 and D_2 of dimension n together with a diffeomorphism of the boundary, then the resulting manifold may not be diffeomorphic to S^n . It will be diffeomorphic if $n \leq 6$. Milnor constructed manifolds which are homeomorphic to S^7 but are not diffeomorphic to S^7 , these manifolds are called *exotic spheres*.

Theorem 12.2.2 (Transversality Theorem). Suppose $F: X \times S \rightarrow Y$ is transverse to $Z \subset Y$. Then for almost all $s \in S$, $F_s: X \rightarrow Y$ is transverse to Z .

Theorem 12.2.3. *Let $f: X \rightarrow Y$ be a smooth function. Then there exists an open set $S \subset \mathbb{R}^N$, with $0 \in S$ and a submersion $F: X \times S \rightarrow Y$ such that $F_0 = f$ (Note that F is transverse to Z , for any Z). Moreover, the map $S \rightarrow Y$ given by $s \rightarrow F(x, s)$ is a submersion for all $x \in X$.*

Proof. If $Y = \mathbb{R}^N$ take $S = \mathbb{R}^N$ and $F(x, s) = f(x) + s$. We shall only prove the general case when X and Y are compact. Let $r: U \rightarrow Y$ be an ϵ -neighbourhood retraction (U and Y are both subsets of \mathbb{R}^N). Define $G: X \times \mathbb{R}^N \rightarrow \mathbb{R}^N$ by $G(x, s) = f(x) + s$. Let \tilde{S} be an open ϵ -ball around the origin in \mathbb{R}^N and note that $G(X \times \tilde{S}) \subseteq U$. Now define $\tilde{F}: X \times \tilde{S} \rightarrow Y$ by $\tilde{F}(x, s) = r(G(x, s))$.

Claim: \tilde{F} is a submersion at all points of $X \times \{0\}$.

Fix $(x, 0) \in X \times \{0\}$ and consider $\tilde{F}|_{\{x\} \times \tilde{S}}$:

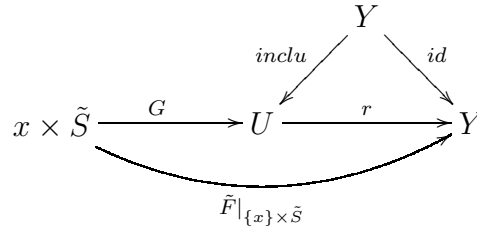

By taking derivatives we get the following diagram:

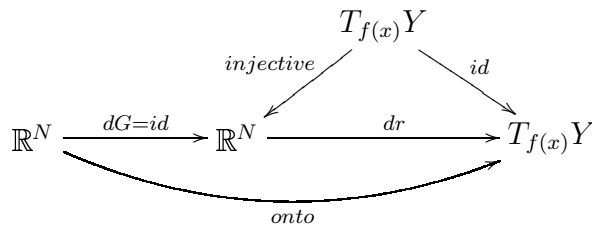

□

Theorem 12.2.4. *Let $Y \subset \mathbb{R}^n$ be a compact manifold and $f: X \rightarrow Y$ a continuous map. Then for every $\epsilon > 0$ there exists a smooth map $g: X \rightarrow Y$ such that $\|g(x) - f(x)\| < \epsilon$ for all $x \in X$.*

Proof. Let $r: U \rightarrow Y$ be an $\frac{\epsilon}{2}$ retraction and $g': X \rightarrow \mathbb{R}^n$ a smooth map with $\|f(x) - g'(x)\| < \frac{\epsilon}{2}$ for all $x \in X$. Note that $g'(x) \subset U$. So define

$g = r \circ g'$. Then

$$\begin{aligned} \|g(x) - f(x)\| &\leq \|g(x) - g'(x)\| + \|g'(x) - f(x)\| \\ &< \frac{\epsilon}{2} + \frac{\epsilon}{2} = \epsilon. \end{aligned}$$

□

Theorem 12.2.5. *Let $Y \subset \mathbb{R}^n$ be a compact manifold. Then there exists an $\epsilon > 0$ such that whenever two continuous maps $f, g: X \rightarrow Y$ satisfy $\|f(x) - g(x)\| < \epsilon$, then they are homotopic.*

Proof. Let $r: U \rightarrow Y$ be an ϵ -neighbourhood retraction. We shall show that this epsilon works. Define $G: X \times [0, 1] \rightarrow \mathbb{R}^n$ by $G(x, t) = (1-t)f(x) + tg(x)$ and note that $G(X \times [0, 1]) \subseteq U$. Now define $H: X \times [0, 1] \rightarrow Y$ by $H(x, t) = r(G(x, t))$. This gives us a homotopy from f to g . □

The previous four theorems are the basic tools for degree theory.

Lemma 12.2.1. *If $f, g: S^n \rightarrow S^n$ satisfy $f(x) \neq -g(x)$ for all $x \in S^n$, then $f \simeq g$.*

Proof.

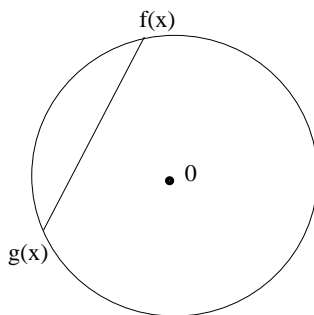

Since $f(x) \neq -g(x)$ the straight line segment joining $f(x)$ to $g(x)$ does not pass through the origin. Hence we can radially project the line segment onto the sphere. This gives us a homotopy from f to g . The homotopy is given by

$$H(x, t) = \frac{(1-t)f(x) + tg(x)}{\|(1-t)f(x) + tg(x)\|}.$$

□

Exercise

1. What manifold do you obtain if you glue to two Möbius bands along their boundary via the identity map.
2. Show that $S^2 \times S^2 - \Delta$ is homotopy equivalent to S^2 .
3. (Surgery) Let $e: S^{m-1} \times D^n \longrightarrow M^{m+n-1}$ be an embedding. Remove $e(S^{m-1} \times \text{Int}(B^n))$ by cutting along $e(S^{m-1} \times S^{n-1})$, and replace it by $\text{Int}B^m \times S^{n-1}$, the attachment being along $e(S^{m-1} \times S^{n-1})$. This process is called surgery and the manifold $\chi(M, e)$ is said to be obtained from M by surgery of type (m, n) . Consider the embedding of $S^0 \times D^2$ in S^2 as shown below.

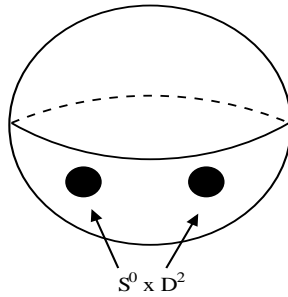

What is the manifold $\chi(S^2, e)$?

13 Intersection Theory

13.1 Intersection Theory mod 2

Question: Is f homotopic to g in the figure below.

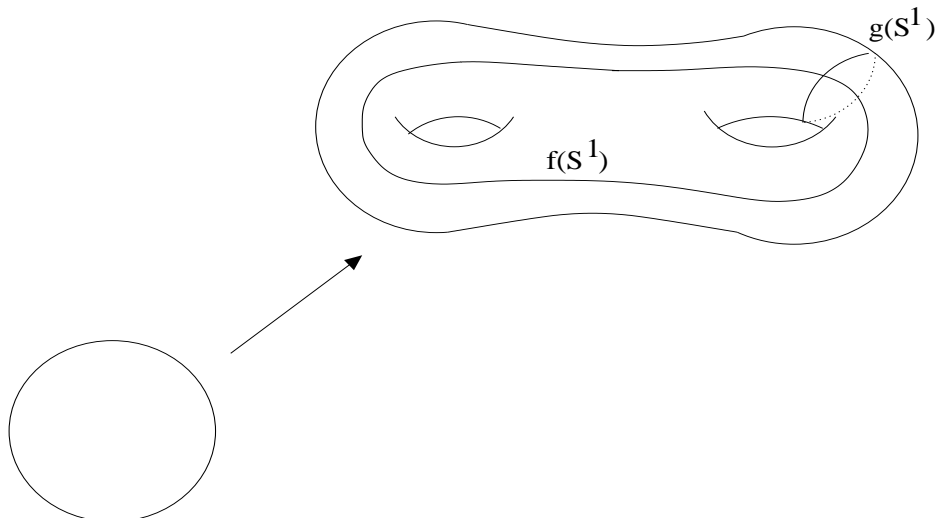

One of the key problems in topology is to determine homotopy classes of mappings, and intersection theory is an extremely useful tool in determining whether two maps are homotopic or not.

Proposition 13.1.1. *Suppose that $f, g: X \rightarrow Y$ are smooth maps which are continuously homotopic. Then they are smoothly homotopic.*

Proof. We shall do this for the case when Y is compact. Let $H: X \times I \rightarrow Y$ be a continuous homotopy, and let ϵ be as in close implies smoothly homotopic. Now let $G: X \times I \rightarrow Y$ be a smooth map that ϵ -approximates H . We now define f' to be G_0 and g' to be G_1 . Then

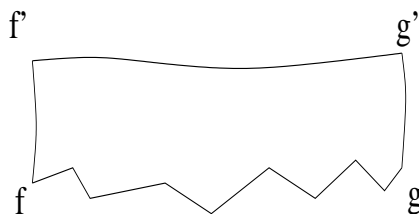

$$\begin{aligned} f &\simeq f' \quad (\text{smoothly homotopic since they are close}) \\ &\simeq g' \quad (\text{smoothly homotopic since } G \text{ is smooth}) \\ &\simeq g \quad (\text{smoothly homotopic since they are close}). \end{aligned}$$

Therefore f is smoothly homotopic to g . □

Throughout this section let X be a closed (compact and without boundary) manifold, and let $Z \subset Y$ be a neat submanifold satisfying the following conditions:

- (1) Z is a closed subset of Y ,
- (2) $Z \cap \partial Y = \partial Z$,
- (3) $Z \pitchfork \partial Y$,
- (4) $\dim X = \text{codim}_Y Z$.

Definition 13.1.1. Let $f: X \rightarrow Y$ be a smooth map with $f \pitchfork Z$. We define the intersection number mod 2 to be

$$I_2(f, Z) := \text{card} f^{-1}(Z) \pmod{2}.$$

Example 13.1.1. Let $f: S^1 \rightarrow T^2$ and Z be as indicated in the diagram below, then $I_2(f, Z) = 1$.

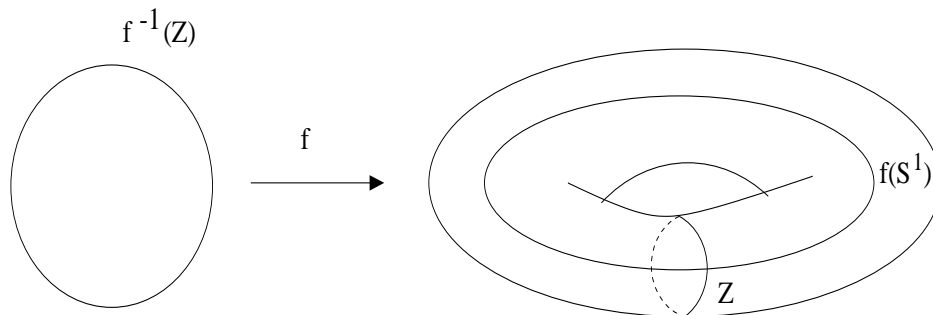

Example 13.1.2. Let $f: S^1 \rightarrow S^1 \times [0, \infty)$ and Z be as indicated in the diagram below, then $I_2(f, Z) = 1$.

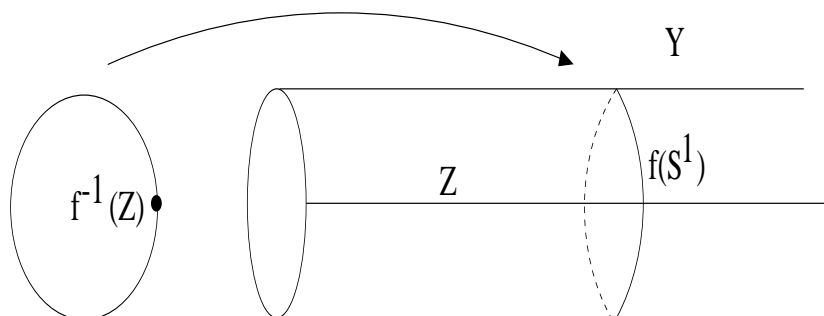

Proposition 13.1.2. Suppose $f, g: X \rightarrow Y$ are smooth maps which are transverse to $Z \subset Y$. Then $I_2(f, Z) = I_2(g, Z)$ if f and g are smoothly homotopic.

Proof. Let $H: X \times I \rightarrow Y$ be a smooth homotopy. We shall first do the easy case when $H \pitchfork Z$. Then $H^{-1}(Z)$ is a neat one dimensional submanifold of $X \times I$.

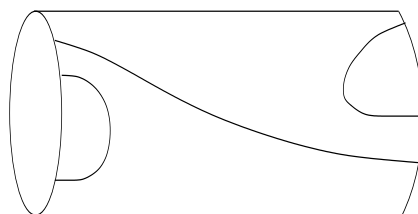

We have $\text{card}(\partial H^{-1}(Z)) \equiv 0 \pmod{2}$. Therefore

$$\text{card}(f^{-1}(Z)) + \text{card}(g^{-1}(Z)) \equiv 0 \pmod{2}.$$

Now consider the case when H may not be transverse to Z . Let $F: X \times I \times S \rightarrow Y$ be a submersion with S an open subset of \mathbb{R}^n which contains

the origin, we also require $F_0 = H$. In particular, $F \pitchfork Z$ because F is a submersion. By the stability theorem there exists a smaller neighbourhood $S_0 \subset S$ (which also contains the origin) such that for all $s \in S_0$, $F_s|_{X \times \{0,1\}} \pitchfork Z$. Now without loss of generality we may assume that S_0 is an open ball around the origin. The transversality theorem tells us there must exist an $s \in S_0$ such that $F_s \pitchfork Z$.

$$\begin{array}{ccc}
 & F_s & \\
 f & \text{-----} & g' \\
 & & \\
 & H & \\
 f & \text{-----} & g
 \end{array}$$

Say F' is a homotopy from f' to g' . Now we have $I_2(f, Z) = I_2(f', Z) = I_2(g', Z) = I_2(g, Z)$. The middle equality comes from the easy case. The maps f and f' are homotopic: $F_t|_{X \times \{0\}}$ is a homotopy from f to f' . Now define $G: X \times [0, s] \rightarrow Y$ by $G(x, t) = F_t(x, 0)$, then G is transverse to Z because F_t is transverse to Z . Hence all the equalities come from the easy case. \square

Definition 13.1.2. Let $f: X \rightarrow Y$ be a smooth map. We define the intersection number of f mod 2 to be

$$I_2(f, Z) := I_2(f', Z),$$

where $f': X \rightarrow Y$ is any smooth map homotopic to f and transverse to Z .

This is well-defined by the following proposition:

Proposition 13.1.3. *If $f, g: X \rightarrow Y$ are smooth and homotopic, then $I_2(f, Z) = I_2(g, Z)$.*

Proof. Let $f', g': X \rightarrow Y$ be smooth maps homotopic to f and g respectively and transverse to Z . Then we have the following:

$$\begin{aligned}
 I_2(f, Z) &= I_2(f', Z) \\
 &= I_2(g', Z) \\
 &= I_2(g, Z).
 \end{aligned}$$

\square

Definition 13.1.3. Let $f: X \rightarrow Y$ be a continuous map. We define the intersection number mod 2 to be

$$I_2(f, Z) := I_2(f', Z),$$

where f' is a smooth map homotopic to f and transverse to Z .

Theorem 13.1.1 (Boundary Theorem). *If X is the boundary of a compact manifold W and if $f: X \rightarrow Y$ extends to $F: W \rightarrow Y$, then $I_2(f, Z) = 0$ for all $Z \subset Y$ satisfying the conditions at the beginning of the section.*

Proof. If necessary, replace F by a map which is smooth, transverse to Z , ∂F is transverse to Z and also is homotopic to F . Then $I_2(f, Z) = \text{card}(f^{-1}(Z)) = \text{card}(\partial F^{-1}(Z)) = 0 \pmod{2}$. The last equality comes from the fact that $\partial F^{-1}(Z)$ is a neat submanifold of dimension one. \square

Example 13.1.3.

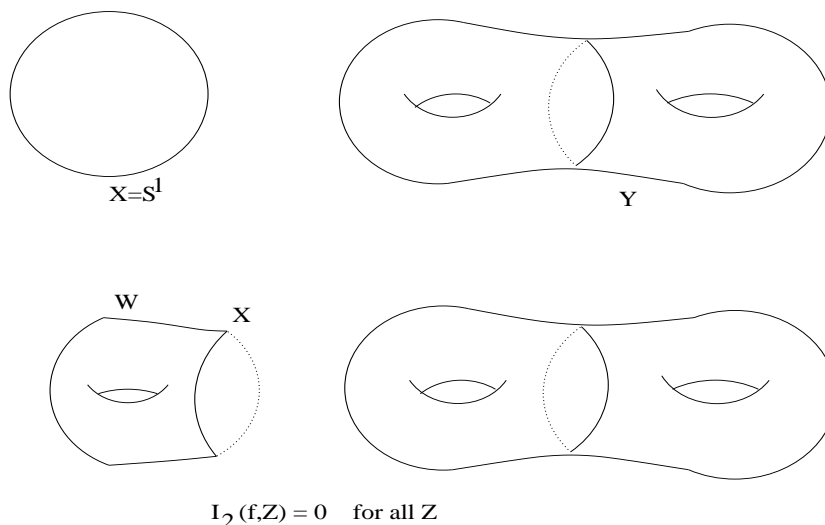

Proposition 13.1.4. *If $f \simeq g: X \rightarrow Y$, with f and g both continuous, then $I_2(f, Z) = I_2(g, Z)$*

Proof.

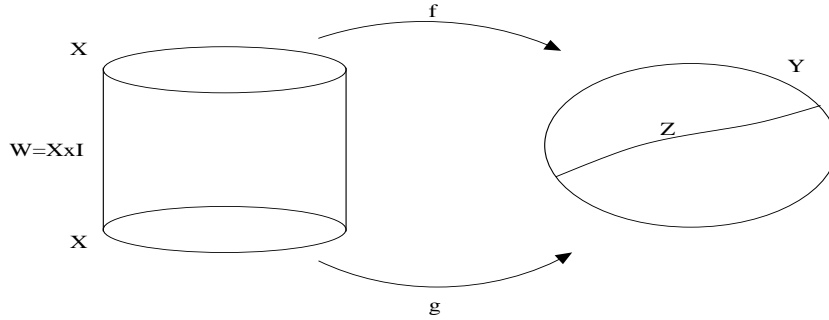

The boundary theorem implies $I_2(f \sqcup g, Z) = 0$, since $W = X \times I$ and $\partial W = X \sqcup X$. Now $I_2(f \sqcup g, Z) = I_2(f, Z) + I_2(g, Z) = 0$. Hence $I_2(f, Z) = I_2(g, Z)$. \square

Exercises

1. Answer the question at the beginning of the section.
2. Let Z be a compact submanifold of Y with $\dim Z = \frac{1}{2} \dim Y$. Show that if the normal bundle $N(Z, Y)$ is trivial, then $I_2(Z, Z) = 0$. In particular, the normal bundle of $N(S^1, M)$ is non-trivial, where S^1 is the central circle in the Möbius band.

13.2 Degree Theory mod 2

Throughout this section let X be a closed manifold, and Y a closed and connected manifold.

Lemma 13.2.1. *Let $f: X \rightarrow Y$ be a smooth map. Then for any $y, y' \in Y$ we have $I_2(f, \{y\}) = I_2(f, \{y'\})$.*

Proof. Fix $y' \in Y$, and let $U = \{y \in Y : I_2(f, \{y\}) = I_2(f, \{y'\})\}$. We have to show that $U = Y$, and to do this we shall show that U is both open and closed. Let $y_0 \in U$. Now replace f , if necessary, by a smooth map transverse to y_0 and homotopic to f . By the stacks of records theorem there exists a neighbourhood $V \ni y_0$ such that $f^{-1}(V)$ is a disjoint union of open sets W_1, \dots, W_k and $f|_{W_i}: W_i \rightarrow V$ is a diffeomorphism. Therefore $V \subseteq U$: since for all $y \in V$, $I_2(f, \{y\}) = I_2(f, \{y_0\})$. The same idea can be used to show that $Y - U$ is open. Now U is a non-empty, open and closed subset of Y , a connected manifold. Hence $U = Y$. \square

Definition 13.2.1. We define the mod 2 degree of f to be

$$\deg_2(f) := I_2(f, \{y\}), \quad \text{where } y \in Y.$$

Remark: This is well-defined by the previous lemma.

Example 13.2.1. Let $f: S^n \rightarrow \mathbb{R}P^n$ be given by $f(x) = [x]$, then $\deg_2(f) = 0$.

If $f: X \rightarrow Y$ is an embedding, then we write $I_2(X, Z) = I_2(f, Z)$.

Example 13.2.2. Let Y be the Möbius band and Z the middle circle. Then $I_2(Z, Z) = I_2(f, Z) = 1$.

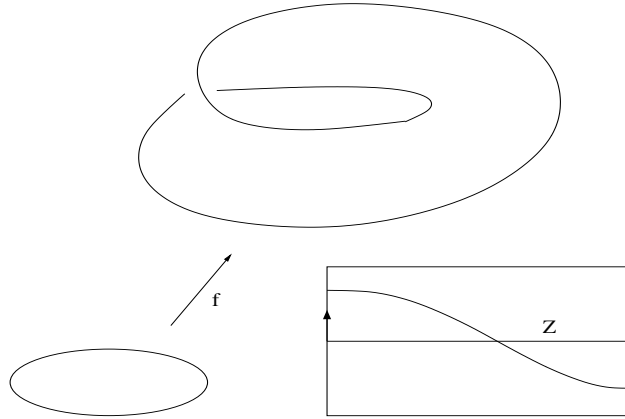

Example 13.2.3. Let $f: X \rightarrow Y$ be the constant map. Then $\deg_2(f) = 0$ unless Y is a point.

Proposition 13.2.1. Let M be a closed and contractible manifold. Then M is a point.

Proof. We have $\deg_2(id: M \rightarrow M) = 1$. Since M is contractible the mod 2 degree of the constant map must be one. Hence, M is a point. \square

Example 13.2.4. The torus is not diffeomorphic to the sphere for the following reason: Every map $f: S^1 \rightarrow S^2$ is homotopic to the constant map. However, for the torus there exists a map $f: S^1 \rightarrow T^2$ such that $I_2(f, Z) = 1$ for some Z , which implies f is not homotopic to the constant map.

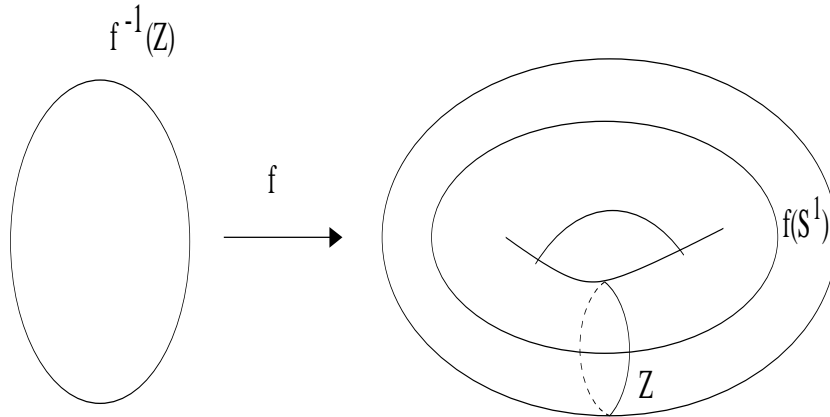

Example 13.2.5. Using the results in this section we can show that the polynomial $p(z) = z^7 + \cos(|z|^2)(1 + 93z^5)$ has a root. Let $Z = \{z \in \mathbb{R} : z > 0\}$ and define $f: S^1 \rightarrow \mathbb{C} - 0$ by $f(z) = p(z)$.

Note: If $I_2(f, Z) = 1$, then f must have a zero inside the unit circle: by the boundary theorem.

Define $g: S^1 \rightarrow \mathbb{C} - 0$ by $g(z) = \cos(|z|^2)(1 + 93z^5)$. Now $|g(z)| > 1$, but $|f(z) - g(z)| = 1$, which implies that f is homotopic to g .

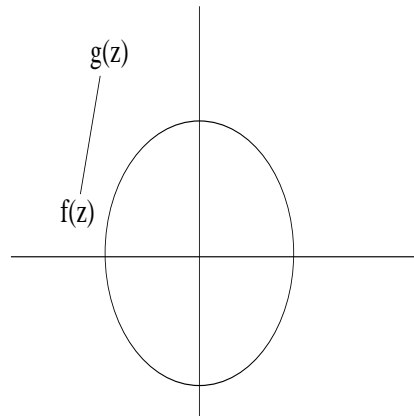

Now define $h: S^1 \rightarrow \mathbb{C} - 0$ by $h(z) = 1 + 93z^5$. Then h is homotopic to g . Finally, we define $k: S^1 \rightarrow \mathbb{C} - 0$, which is homotopic to h . Hence we have $I_2(f, Z) = I_2(g, Z) = I_2(h, Z) = I_2(k, Z) = 1$.

Example 13.2.6. Let $i: S^k \rightarrow S^n$ be the standard inclusion. This map induces a map $\mathbb{R}P^k \rightarrow \mathbb{R}P^n$. We want to show that this map is not homotopic to the constant map. To do this we have to find a Z such that $I_2(\mathbb{R}P^k, Z) = 1$. Let $Y = \{(0, 0, \dots, 0, z_k, \dots, z_n)\} \subseteq S^n$. Then

$S^k \cap Y = \{(0, 0, \dots, \pm 1, 0, \dots, 0)\}$. Hence $\pi(Y) \cap \mathbb{R}P^n$ is just a point, so let $Z = \pi(Y)$.

Lemma 13.2.2. *Any connected topological space M which is locally path-connected is path-connected. In particular, any connected manifold is path-connected.*

Proof. Fix $x_0 \in M$, and let

$$U = \{x \in M : \text{there exists a smooth path from } x \text{ to } x_0\}.$$

Obviously $x_0 \in U$ and U is open since M is locally path connected. If we define an equivalence relation on M by $x \sim y$ if there exists a smooth path from x to y . Then equivalence classes are open. Now equivalence classes partition M , so they must be closed as well. Since M is connected U must be M . \square

Theorem 13.2.1 (Jordan–Brouwer Theorem). *Let $X \subset \mathbb{R}^n$ be a closed, connected manifold of dimension $n - 1$. Then $\mathbb{R}^n - X$ has two components.*

Proof. Let $x \in X$ and choose a standard chart around x .

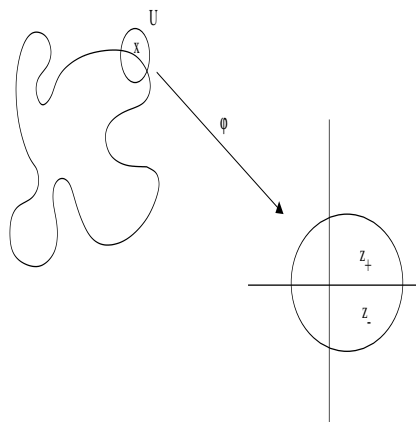

Choose $z_+ \in \phi(U)$ with the n -th coordinate strictly bigger than zero, also, choose $z_- \in \phi(U)$ with the n -th coordinate strictly less than zero. Now let $y_+ = \phi^{-1}(z_+)$ and $y_- = \phi^{-1}(z_-)$. We shall now show that y_+ and y_- are in distinct components of $\mathbb{R}^n - X$. If y_+ and y_- are in the same component, then there is a smooth path $\alpha: [0, 1] \rightarrow \mathbb{R}^n - X$ connecting y_+ and y_- . Now join y_+ and y_- by a path β in the chart that intersects X transversely in one point. Now after reparametrising α and β , if necessary, the union of

two paths defines a smooth map, $\gamma: S^1 \rightarrow \mathbb{R}^n$ with $I_2(\gamma, X) = 1$. But γ is homotopic to the identity so $I_2(\gamma, X) = 0$. This shows that $\mathbb{R}^n - X$ has at least two components. To show that there are at most two components we need the following lemma:

Lemma 13.2.3. *For all $x \in X$ and every neighbourhood U of x , and every $z \in \mathbb{R}^n - X$, there is a smooth path in $\mathbb{R}^n - X$ joining z to a point of U .*

Proof. There exists a $y \in X$ such that y is the closest point on X to z . We join z to y by a straight line, this line lies in $\mathbb{R}^n - X$, since y is the closest point. Now X is connected so there exists a path in X joining y to x . This path in X can be pushed off X to obtain a path in $\mathbb{R}^n - X$ joining a point in U to a point in the neighbourhood of y . Now it is easy to construct a smooth path joining z to a point in U . \square

Now apply the lemma to the chart $\phi: U \rightarrow \mathbb{R}^n$ around x . Assuming there are at least three components. Choose representative points z_1, z_2 and z_3 and join them by paths in $\mathbb{R}^n - X$, call the points in U that they join to y_1, y_2 and y_3 . But $U - X$ has two components by construction. So two of y_1, y_2, y_3 are in the same component.

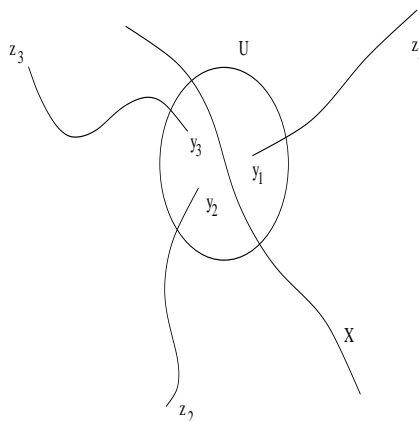

\square

13.3 Orientation

One way to think about $Gl_n(\mathbb{R})$, is to think of it as the space of bases for \mathbb{R}^n .

Theorem 13.3.1. *The manifold $Gl_n(\mathbb{R})$ has two components.*

Proof. The determinant map $\det: Gl_n(\mathbb{R}) \rightarrow \mathbb{R} - \{0\}$ tells us that $Gl_n(\mathbb{R})$ has at least two components.

We shall show that for any matrix $A \in Gl_n(\mathbb{R})$ with positive determinant there exists a path $\gamma: I \rightarrow Gl_n(\mathbb{R})$ such that $\gamma(0) = A$ and $\gamma(1) = I$.

Let (A_1, A_2, \dots, A_n) denote the columns of A . The Gram–Schmidt algorithm shows there exists an orthonormal basis (E_1, \dots, E_n) for \mathbb{R}^n such that

$$\begin{aligned} A_1 &= R_{11}E_1 \\ A_2 &= R_{21}E_1 + R_{22}E_2 \\ &\vdots \\ A_n &= R_{n1}E_1 + R_{n2}E_2 + \dots + R_{nn}E_n \end{aligned}$$

for some constants R_{ij} . Replacing E_i by $-E_i$, if necessary, we may assume that $R_{ii} > 0$ for each i . In matrix notation

$$A = ER,$$

where E is an orthogonal matrix and R is an upper triangular matrix with positive entries on the diagonal. Since the determinant of A and R are both positive, then the determinant of E has to be positive. Therefore $E \in SO(n)$. Let $R_t = tI_n + (1-t)R$. Then it is clear that R_t is a upper triangular matrix with positive entries on the diagonal. The path $\alpha: I \rightarrow Gl_n(\mathbb{R})$ given by $\alpha(t) = ER_t$ is a path from A to E . There exists a path from E to I since $SO(n)$ is connected (see the exercises in this section). Therefore if we concatenate these two paths we obtain a path from A to I . \square

The motivation for orientation comes from the fact that $Gl_n(\mathbb{R})$ has two components. Since $Gl_n(\mathbb{R})$ has two components we can define an equivalence relation on $Gl_n(\mathbb{R})$ in the following way: Two elements A, B are equivalent if they belong in the same component of $Gl_n(\mathbb{R})$.

Remark: In the case of complex manifolds all manifolds are orientable because $Gl_n(\mathbb{C})$ is connected.

We define an *orientation* for \mathbb{R}^n as an equivalence class of ordered bases. If \mathbb{R}^n is oriented then any ordered basis (e_1, \dots, e_n) that is in the given orientation is said to be *positively oriented*, if it is not in the given orientation then it is said to be *negatively oriented*. In the special case we define an orientation for a zero-dimensional vector space to be simply a choice of one of the numbers ± 1 .

Example 13.3.1. At each point $x \in \mathbb{R}^3$ we have $T_x(\mathbb{R}^3) \cong \mathbb{R}^3$. We now orient each tangent space with the ordered basis $\{e_1, e_2, e_3\}$. This orientation is the standard orientation of \mathbb{R}^3 .

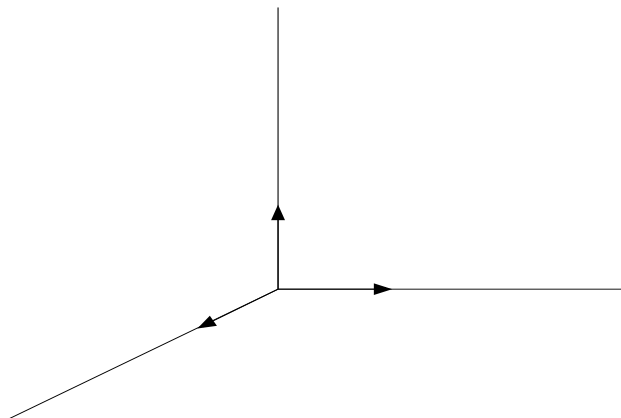

Example 13.3.2. At each $x \in \mathbb{R}^n$ we have $T_x(\mathbb{R}^n) \cong \mathbb{R}^n$. We can orient each tangent space with the ordered basis $\{e_1, e_2, \dots, e_n\}$. This orientation is the standard orientation for \mathbb{R}^n .

Definition 13.3.1. Suppose $\pi: E \rightarrow X$ is a smooth vector bundle. An orientation on the bundle is a choice of orientation on each vector space $\pi^{-1}(x)$ satisfying the local triviality condition: For all $x \in X$ there exists a neighbourhood U , containing x , and a diffeomorphism $h: U \times \mathbb{R}^n \rightarrow \pi^{-1}(U)$ such that the following diagram commutes:

$$\begin{array}{ccc}
 U \times \mathbb{R}^n & \xrightarrow{h} & \pi^{-1}(U) \\
 \searrow \text{Proj}_U & & \swarrow \pi \\
 & U &
 \end{array}$$

and $h: p \times \mathbb{R}^n \rightarrow \pi^{-1}(p)$ is an orientation preserving isomorphism (with the standard orientation on \mathbb{R}^n) for all $p \in U$.

Definition 13.3.2. An orientation of a manifold is an orientation of its tangent bundle.

Example 13.3.3. We saw earlier that $T(S^1) = \{(a, b), \lambda(-b, a) : a^2 + b^2 = 1, \lambda \in \mathbb{R}\}$. At each space $T_{(a,b)}(S^1)$ we assign the basis vector $(-b, a)$. This gives us an orientation of the tangent bundle.

If $M \subset Y$ is a submanifold the transverse orientation of M in Y is an orientation of the normal bundle $N(M, Y)$.

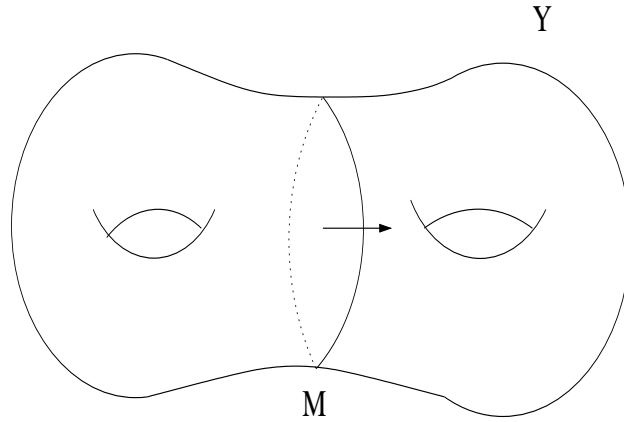

There are two principles that make degree theory work.

(1). Let $f: X \rightarrow Y$ be a smooth map transverse to $Z \subset Y$. Then a transverse orientation of Z in Y induces a transverse orientation of $f^{-1}(Z)$ in X : Let $x \in f^{-1}(Z)$. Then $df_x: T_x(X) \rightarrow T_{f(x)}Y$ induces a map $df_x: T_x(f^{-1}(Z)) \rightarrow T_{f(x)}(Z)$. By definition

$$N_x(f^{-1}(Z), X) = T_x(X)/T_x(f^{-1}(Z))$$

and

$$N_{f(x)}(Z, Y) = T_{f(x)}Y/T_{f(x)}Z,$$

hence df_x induces an isomorphism between $N_x(f^{-1}(Z), X)$ and $N_{f(x)}(Z, Y)$. Now orient $N_x(f^{-1}(Z), X)$ using the isomorphism and the given orientation on $N_{f(x)}(Z, Y)$.

Example 13.3.4. Let $S = \{(t, t^3) \in \mathbb{R}^2 : t \in \mathbb{R}\}$. Then S is the preimage of zero under the map $F: \mathbb{R}^2 \rightarrow \mathbb{R}$ given by $F(x, y) = x^3 - y$. Now $N_0(0, \mathbb{R})$ is isomorphic to $T_0(\mathbb{R})$ and we give this vector space the standard orientation. Now $dF_{(x,y)}: \mathbb{R}^2 \rightarrow \mathbb{R}$ is given by the matrix $[3x^2 \ 1]$ therefore the tangent space is spanned by the vector $(1, 3x^2)$ and the normal space is spanned by the vector $(-3x^2, 1)$. Now $dF_{(x,y)}$ induces an isomorphism between $N_{(x,y)}(S)$ and $T_0(\mathbb{R})$, hence the vector $(3x^2, -1)$ is the positive basis vector for $N_{(x,y)}(S, X)$

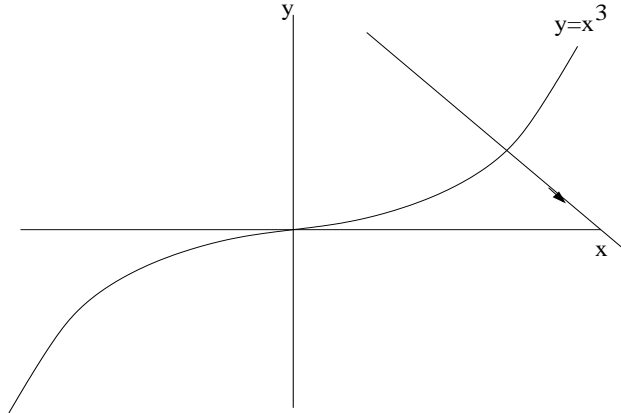

(2) If X is an oriented manifold and Y is a submanifold, then an orientation of Y determines a transverse orientation of Y and vice versa.

$$N_y(Y, X) \oplus T_y(Y) = T_y(X)$$

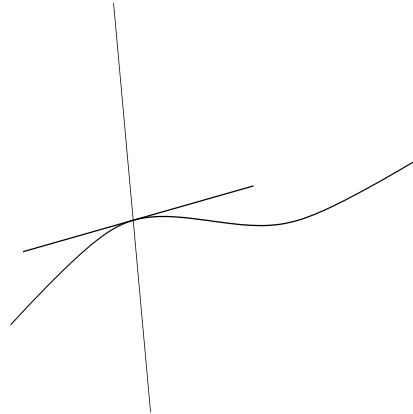

compatibly orientable: $\text{sign}(b, c) = \text{sign}(b) \text{sign}(c)$.

Example 13.3.5. In the previous example we obtained a transverse orientation for S . If we give \mathbb{R}^2 the standard orientation, then the vector $(1, 3x^2)$, which spans the tangent space $T_{(x,y)}(S)$ is a negatively oriented basis vector.

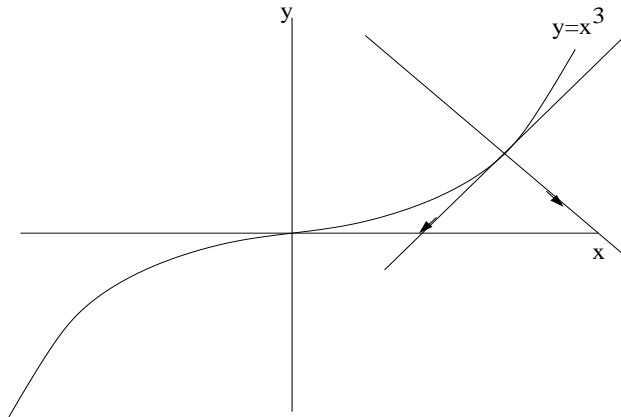

If X is an orientable manifold, we orient the boundary by the rule $\text{sign}_X(\vec{n}, \vec{b}) = \text{sign}_{\partial X}(\vec{b})$, where \vec{n} is the outward normal.

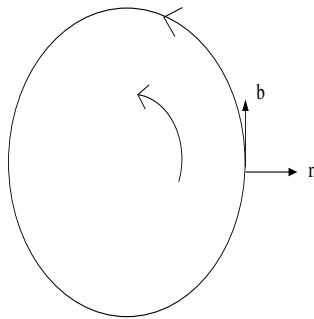

Example 13.3.6. Let $x = (a, b, c) \neq (\pm 1, 0, 0)$ be a point on the sphere S^2 which is the boundary of D^3 . We now give D^3 the standard orientation, i.e., the orientation induced from the standard orientation of \mathbb{R}^3 . The vector (a, b, c) is the outward normal for D^3 .

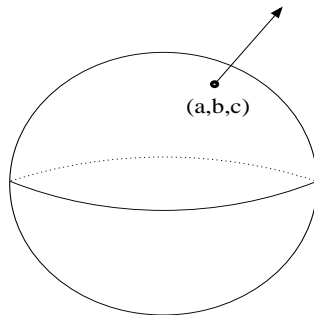

A basis for $T_x(\partial D^3)$ is given by $\{(0, -c, b), (b^2 + c^2, -ab, -ac)\}$. And thus a basis for D^3 is

$$\{(a, b, c), (0, -c, b), (b^2 + c^2, -ab, -ac)\}$$

The matrix that sends the standard basis of \mathbb{R}^3 to this basis is

$$\begin{pmatrix} a & 0 & b^2 + c^2 \\ b & -c & -ab \\ c & b & -ac \end{pmatrix},$$

which has determinant $b^2 + c^2 > 0$. Therefore the basis for $T_x(\partial D^3)$ is positively oriented.

Lemma 13.3.1. *The boundary of every oriented compact one manifold gives a total orientation count of zero.*

Proof

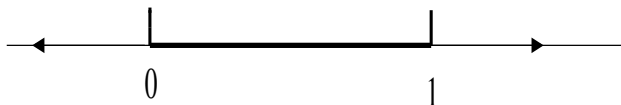

The outward pointing normal at the point 1 tell us that the orientation on the boundary must be a positive orientation. The outward pointing normal at the point 0 tells us that the boundary orientation must be a negative orientation. Therefore the total orientation count of zero. \square

Exercises

- (a) Let $p_0 \in S^{n-1}$ be the point $(0, \dots, 0, 1)$. For $n \geq 2$ define

$$f: SO(n) \longrightarrow S^{n-1}$$

by $f(A) = A(p_0)$. Show that f is smooth and open, hence onto. Show that $f^{-1}(p_0)$ is homeomorphic to $SO(n-1)$, and then show that $f^{-1}(p)$ is homeomorphic to $SO(n-1)$ for all $p \in S^{n-1}$.

- (b) $SO(1)$ is a point, so it is connected. Using part (a), and induction on n , prove that $SO(n)$ is connected for all $n \geq 1$.
- Show that $Gl_n(\mathbb{R})$ is diffeomorphic to $O(n) \times \mathbb{R}^k$, where $k = \frac{n(n+1)}{2}$.
- Show that $Gl_n(\mathbb{C})$ is connected.
- Show that any closed, connected hypersurface $X \subset \mathbb{R}^n$ is orientable.
- Let Z be a orientable hypersurface of a orientable manifold Y . Show that the normal bundle $N(Z, Y)$ is trivial. Use this to deduce that the Möbius band is not orientable.

6. Show that parallelizable manifolds are orientable.
7. Let X be the solid torus. Now glue two copies of X via the identity map on the boundary. What is the resulting closed, connected, orientable 3-manifold? This is an example of a *Heegaard splitting*. In general, a Heegaard splitting of a closed, connected, orientable 3-manifold M is a pair of handle bodies X and Y contained in M such that $X \cup Y = M$ and $X \cap Y = \partial X = \partial Y$. It is a theorem of 3-manifolds that says any closed, connected, orientable 3-manifold has a Heegaard splitting.
8. Show that the tangent bundle of a manifold, considered as a manifold, is always orientable.

13.4 Oriented Intersection Number

Let X, Y and Z be manifolds, with X closed, and Z a submanifold of Y with $\dim X = \text{codim}_Y Z$. Also, suppose that X is oriented and Z is transversely oriented. Now let $f: X \rightarrow Y$ be a smooth map which is transverse to Z . The goal of this section is to find the oriented intersection number. We know that $f^{-1}(Z)$ is a zero dimensional compact submanifold in X . There are two orientations of $T_x(X)$ for each $x \in f^{-1}(Z)$. If the orientation at $T_x(X)$ induced by the transverse orientation of Z agrees with the orientation of X , then assign $+1$ to that point, otherwise assign -1 to that point. Then the oriented intersection number of f with Z , denoted $I(f, Z)$, is the total count of all signs in $f^{-1}(Z) \in \mathbb{Z}$.

Example 13.4.1.

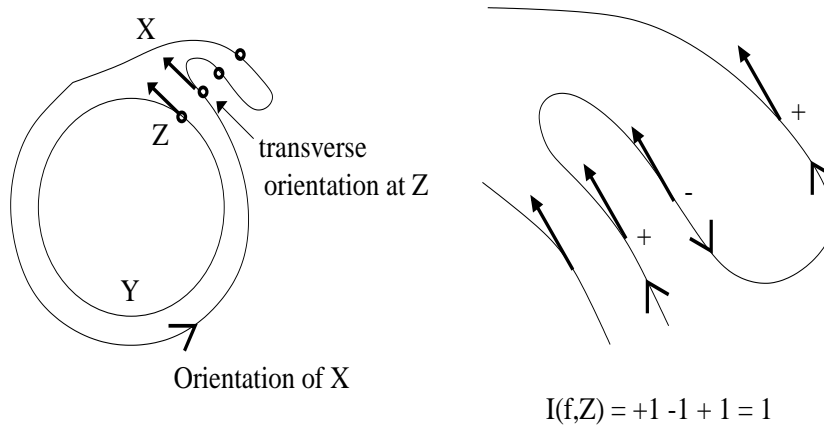

Proposition 13.4.1. *Suppose $f: X \rightarrow Y$ extends to a map $F: W \rightarrow Y$, where W is a compact manifold with $\partial W = X$ and F is transverse to Z , a submanifold of Y . Then $I(f, Z) = 0$.*

Proof. Consider the compact one manifold $F^{-1}(Z) \subset W$.

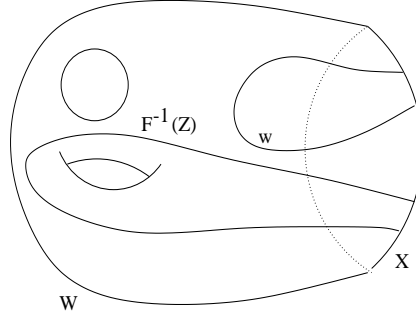

Now first put the transverse orientation on $F^{-1}(Z)$ by pulling back the transverse orientation of Z . Then, put the orientation on $F^{-1}(Z)$ using $N \oplus T = T_w$. We now consider an endpoint x of an arc in F^{-1} .

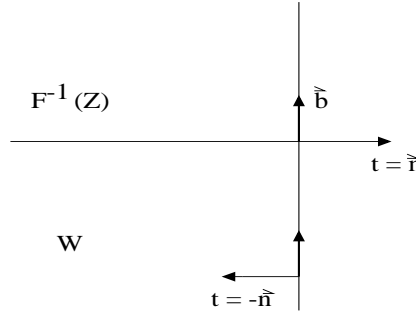

Let \vec{b} be a basis vector of $T_x(X)$ and t a vector in $T_x(F^{-1}(Z))$. Then

$$\begin{aligned} \text{sign}(\vec{b}, t) &= (-1)^{\text{codim } Z} \text{sign}(t, \vec{b}) \\ &= \begin{cases} (-1)^{\text{codim } Z}, & t = \vec{n} \\ -(-1)^{\text{codim } Z}, & t = -\vec{n} \end{cases} \end{aligned}$$

So the endpoints of the same arc have opposite signs. □

Now extend $I(f, Z)$ to continuous maps $f: X \rightarrow Y$ by the rule $I(f, Z) = I(f', Z)$, where $f \simeq f'$, f' is smooth and f' is transverse to Z . This definition is well-defined because of the following proposition:

Proposition 13.4.2. *If $f \simeq g$, then $I(f, Z) = I(g, Z)$.*

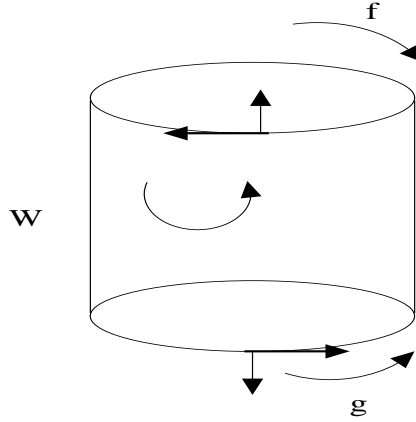

Proof. Let $W = X \times I$. Then $\partial W = X_1 - X_0$. Now $I_X(f, Z) = -I_X(f, Z)$, hence $I(f, Z) - I(g, Z) = I(\partial H, Z) = 0$ (by the previous proposition). \square

Proposition 13.4.3. *A manifold M is orientable if, and only if, it has an atlas with all transition maps orientation preserving.*

Proof. (\Leftarrow). Let $x \in M$, $\phi: U \rightarrow \mathbb{R}^n$ a chart with $x \in U$. We then declare $d\phi_x: T_x(M) \rightarrow \mathbb{R}^n$ to be orientation preserving. (\Rightarrow). If M is oriented, define an atlas to be those charts which are orientation preserving. \square

13.5 Mapping Class Groups

Let S be a compact, orientable surface. Let $\text{Mod}(S)$ denote the group of orientation preserving diffeomorphisms modulo isotopy. Given curves on S , α and β , the (geometric) *intersection number* between the two curves, denoted $i(\alpha, \beta)$, is defined to be the minimum number of intersection points between any curves a and b where a and b are homotopic to α and β respectively.

1. Let $\text{Mod}^\pm(T^2)$ be the group of diffeomorphisms of the torus modulo isotopy. Show that $\text{Mod}^\pm(T^2) = \text{Gl}_2(\mathbb{Z})$ and $\text{Mod}(T^2) = \text{Sl}_2(\mathbb{Z})$.
2. Show that two closed curves α, β generate $\pi_1(T^2)$ if, and only if, $i(\alpha, \beta) = 1$.
3. If α and β are the latitude and longitude curves on a torus, T^2 , then define $(p, q) \in \pi_1(T^2)$ to be $p\alpha + q\beta$ (the curve that winds around the latitude direction p times and the longitude direction q times). Show that $I((p, q), (p', q')) = pq' - p'q$.

4. Let C be a closed curve on an closed orientable surface, then C has a neighbourhood A homeomorphic to an annulus. The *Dehn twist* in C is defined to be the diffeomorphism T_c given by the identity off A and by the map $(r, \theta) \rightarrow (r, \theta + 2\pi r)$ on A .

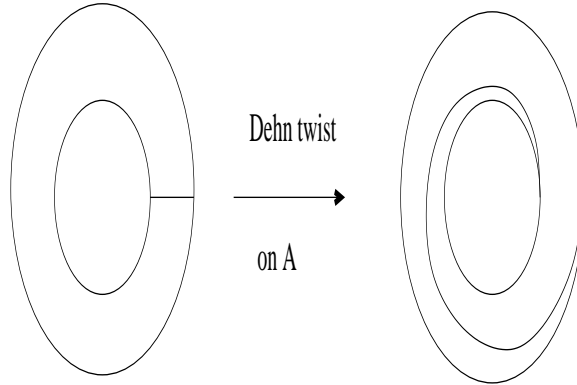

Let a and b be simple closed curves on S_g . Prove that if $T_a = T_b$, then a is isotopic to b .

5. Let a and b be any simple closed curves on S_g . Then:

$$i(T_a(b), b) = i(a, b)^2.$$

6. Use the previous result to prove the following: If $i(a, b) \neq 0$, then $T_a(b) \neq b$.
7. Let $f \in \text{Mod}(S_g)$. Show that $T_{f(\alpha)} = f \circ T_\alpha \circ f^{-1}$.
8. Show that $T_a T_b = T_b T_a$ if, and only if, $i(a, b) = 0$.
9. Prove the following: Let a and b be non-isotopic simple closed curves on S_g . If $T_a T_b T_a = T_b T_a T_b$, then $i(a, b) = 1$.
10. If α and β are both isotopy classes of nonseparating simple closed curves in S_g , then there is an element $f \in \text{Mod}(S_g)$ such that $f(\alpha) = \beta$.
11. Let α and β be simple closed curves on the surface S_g . Show that if $i(\alpha, \beta) = 1$, then $T_\alpha T_\beta(\alpha) = \beta$. Hint: A neighbourhood of α and β is a punctured torus, so one can check the result by hand.
12. (Curve Complex) The vertices of the *complex of curves* $C(S)$ are the isotopy classes of simple closed curves, we call them circles, which are

non-trivial, i.e., not contractible in S into a point or into the boundary of ∂S . We denote the isotopy class of a circle C by $\langle C \rangle$. A set of vertices $\{v_0, \dots, v_n\}$ is declared to be a simplex if, and only if, $v_0 = \langle C_0 \rangle, \dots, v_n = \langle C_n \rangle$ for some pairwise disjoint circles C_0, \dots, C_n . Now let S be a non-sporadic surface (a sporadic surface is one which is a sphere with less than five punctures or a torus with less than two punctures). Let α and β be two simple closed curves in S . Complete the following questions to show that there exists a sequence $\alpha = \gamma_1, \gamma_2, \dots, \gamma_n = \beta$ such that $i(\gamma_i, \gamma_{i+1}) = 0$.

- (a) We shall use induction on $i(\alpha, \beta)$. Of course, if $i(\alpha, \beta) = 0$ there is nothing to prove. If $i(\alpha, \beta) = 1$, show there exists a curve γ disjoint from both.
- (b) Now suppose that $i(\alpha, \beta) > 1$. It remains to show there exists a curve γ such that $i(\alpha, \gamma)$ and $i(\beta, \gamma)$ are less than $i(\alpha, \beta)$. We give a recipe for finding γ : Let a and b be two curves representing α and β . Pick any intersection point of a and b . Follow a to the next intersection point with b . If this second intersection point has the same index as the first, then γ can be chosen as in the Figure 1(a). Otherwise, Figure 1(b) applies (at least one of γ_1 or γ_2 will have the desired properties).

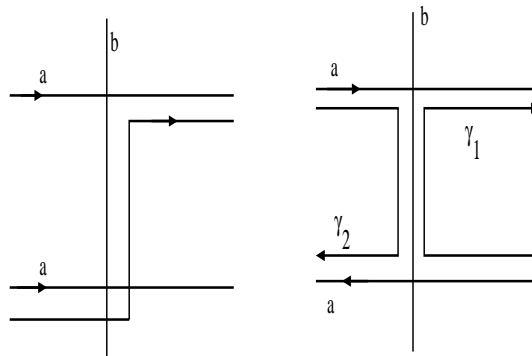

Show that γ has the desired properties. In particular, show that γ_1 or γ_2 is essential, and that $i(\alpha, \gamma)$ and $i(\beta, \gamma)$ are smaller than $i(\alpha, \beta)$.

- (c) Show that the curve complex for S is connected.
- (d) Show that the curve complex for the torus is homotopy equivalent to a wedge of spheres.

13.6 Degree theory

Let M and N be closed oriented manifolds, with $\dim M = \dim N$ and N connected. Let $f: M \rightarrow N$ be a map.

Lemma 13.6.1. *The number $I(f, \{y\})$ does not depend on the choice of $y \in N$.*

Remark: N has to be connected. For example, let $M = S^1$, N be the disjoint union of two circles and $f: M \rightarrow N$ be the map which sends S^1 onto one of the circles.

Definition 13.6.1. The *degree* of f is defined to be

$$\deg(f) := I(f, \{y\}).$$

This is well-defined by the previous lemma.

If f is smooth and y is a regular value, then $f^{-1}(y)$ is a finite set of points. So let $f^{-1}(y) = \{x_1, x_2, \dots, x_k\}$. Then the orientation number at x_i is

$$\begin{cases} +1, & \text{if } df_{x_i}: T_{x_i}(M) \rightarrow T_y(N) \text{ is orientation preserving,} \\ -1, & \text{if } df_{x_i}: T_{x_i}(M) \rightarrow T_y(N) \text{ is orientation reversing,} \end{cases}$$

and the degree of f is the sum of all the orientation numbers.

Example 13.6.1. The degree of the identity map is one.

Example 13.6.2. Let $\rho: S^1 \rightarrow S^1$ be the map $z \rightarrow \bar{z}$. Then ρ is just the reflection in the x -axis. The map $\tilde{\rho}: \mathbb{C} \rightarrow \mathbb{C}$ given by $z \rightarrow \bar{z}$ is orientation reversing, since the matrix of this map is

$$\begin{pmatrix} 1 & 0 \\ 0 & -1 \end{pmatrix},$$

which has determinant -1 . Hence ρ is orientation reversing. Thus $\deg(\rho) = -1$.

Example 13.6.3. Let $f: S^1 \rightarrow S^1$ be given by $z \rightarrow z^m$, with $m > 0$. Now declare the map $\alpha: \mathbb{R} \rightarrow \mathbb{R}$ given by $t \rightarrow (\cos t, \sin t)$ to be orientation preserving. Now f sends $(\cos t, \sin t)$ to $(\cos mt, \sin mt)$. Therefore, the lifted map \tilde{f} is just multiplication by m , which is orientation preserving.

$$\begin{array}{ccc} \mathbb{R} & \xrightarrow{\tilde{f}(t)=mt} & \mathbb{R} \\ \downarrow & & \downarrow \\ S^1 & \xrightarrow{f} & S^1 \end{array}$$

The map f must be orientation preserving because all the others are. Hence the degree of f is m .

Proposition 13.6.1. *Let $f: M \rightarrow N$ and $g: N \rightarrow O$ be smooth maps. Then $\deg(gf) = \deg(g)\deg(f)$.*

Example 13.6.4. Let $a: S^n \rightarrow S^n$ be the antipodal map, that is $x \rightarrow -x$. Define $\tilde{a}: \mathbb{R}^{n+1} \rightarrow \mathbb{R}^{n+1}$ by $x \rightarrow -x$. The matrix of this linear transformation is

$$\begin{pmatrix} -1 & & & \\ & -1 & & \\ & & \ddots & \\ & & & -1 \end{pmatrix}.$$

Then \tilde{a} is orientation preserving if, and only if, n is odd. Hence a is orientation preserving if, and only if, n is odd. Thus, the degree of $a: S^n \rightarrow S^n$ is $(-1)^{n+1}$. We can conclude from this that when n is even, a is not homotopic to the identity.

Theorem 13.6.1. *The manifold $\mathbb{R}P^n$ is orientable if, and only if, n is odd.*

We know this is true for $n = 1$, since $\mathbb{R}P^1 = S^1$. Now $\mathbb{R}P^2$ contains a Möbius band, hence is non-orientable. Suppose $\mathbb{R}P^n$ is orientable, then define an orientation on S^n by pulling back $\pi: S^n \rightarrow \mathbb{R}P^n$ (the quotient map), i.e., declare that $d\pi: T_x(S^n) \rightarrow T_{\pi(x)}(\mathbb{R}P^n)$ is orientation preserving. Now $a: S^n \rightarrow S^n$ is orientation preserving because:

$$\begin{array}{ccc} S^n & \xrightarrow{a} & S^n \\ & \searrow \pi & \swarrow \pi \\ & \mathbb{R}P^n & \end{array}$$

$$\begin{array}{ccc} T_x(S^n) & \xrightarrow{da} & T_{-x}(S^n) \\ & \searrow \begin{matrix} o.p \\ d\pi \end{matrix} & \swarrow \begin{matrix} o.p \\ d\pi \end{matrix} \\ & T_{\pi(x)}(\mathbb{R}P^n) & \end{array}$$

So by computation of degree, n must be odd. When n is odd, define an orientation on $\mathbb{R}P^n$ via the above diagram.

Exercises

1. Given a map $f: S^n \rightarrow S^n$ we define the suspension of f denoted Sf to be the map $Sf: S^{n+1} \rightarrow S^{n+1}$ given by

$$Sf(x_1, \dots, x_{n+2}) = \left((\sqrt{1 - x_{n+2}^2})f\left(\frac{x_1}{\sqrt{1 - x_{n+2}^2}}, \dots, \frac{x_{n+1}}{\sqrt{1 - x_{n+2}^2}}\right), x_{n+2} \right)$$

if $-1 < x_{n+2} < 1$ and

$$Sf(x_1, \dots, x_{n+2}) = \pm 1$$

if $x_{n+2} = \pm 1$. Show the suspension map $Sf: S^{n+1} \rightarrow S^{n+1}$ has the same degree as f . Conclude that there are maps $f: S^n \rightarrow S^n$ of any given degree.

2. Show that if a map $f: S^n \rightarrow S^n$ has no fixed points, then $\deg(f) = (-1)^{n+1}$.
3. Prove Brouwer's fixed point theorem using degree theory.
4. Let C_1 and C_2 be two disjoint oriented simple closed curves in \mathbb{R}^3 . Define $f: C_1 \times C_2 \rightarrow S^2$ by $f(x_1, x_2) = \frac{x_1 - x_2}{\|x_1 - x_2\|}$ (here $C_1 \times C_2$ is given the product orientation). Then the *linking number* $l(C_1, C_2)$ is defined to be the degree of f . Find the linking number for the two circles shown below.

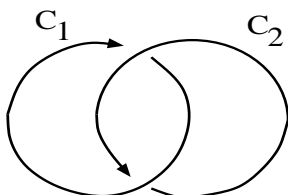

5. Let $\pi: S^n \rightarrow \mathbb{R}P^n$ and $q: \mathbb{R}P^n \rightarrow \mathbb{R}P^n / \mathbb{R}P^{n-1} = S^n$ both be the respective quotient maps. Calculate the degree of the map $f = q \circ \pi: S^n \rightarrow S^n$.
6. Let M be a closed, connected oriented n -manifold. Show that there exists a map $f: M \rightarrow S^n$ of degree k , where k is an integer.
7. Prove the no retraction theorem using degree theory.
8. Let M_g denote a closed surface of genus g . Show there exists a degree one map $f: M_g \rightarrow M_h$, where $g \geq h$.
9. Show that \mathbb{R}^{2n+1} is not a division algebra over \mathbb{R} if $n > 0$. (Hint: If it were, then for a nonzero element a of \mathbb{R}^{2n+1} the two mappings $S^{2n} \rightarrow S^{2n}$ given by $x \rightarrow \frac{ax}{|ax|}$ and $x \rightarrow \frac{-ax}{|ax|}$ are defined. Now what can you say about these two mappings).

10. Show that any map $f: S^n \rightarrow T^n$, where $n > 1$, has degree zero. You may use the result that says any map $f: S^n \rightarrow T^n$, where $n > 1$, lifts to a map $\tilde{f}: S^n \rightarrow \mathbb{R}^n$ such that $\pi \circ \tilde{f} = f$, where $\pi: \mathbb{R}^n \rightarrow T^n$ is the quotient map.
11. Show that you cannot embed $\mathbb{R}P^{2n}$ into \mathbb{R}^{2n+1} . Hence Whitney's result is the best you can do.
12. Show that S^n has a nowhere zero vector field if, and only if, n is odd. Hint: If S^n does have a nowhere zero vector field construct a homotopy from the identity to the antipodal map. In the case n is odd construct a vector field on S^n which is nowhere zero.
13. Show that even dimensional spheres of positive dimension are not parallelizable.

14 Vector Fields and the Poincaré–Hopf Theorem

Let $U \subset \mathbb{R}^n$ be an open set and $v: U \rightarrow \mathbb{R}^n$ a vector field (say continuous)

Example 14.0.5. Let $U = \mathbb{R}^2$, and let $V: U \rightarrow \mathbb{R}^2$ be the constant map.

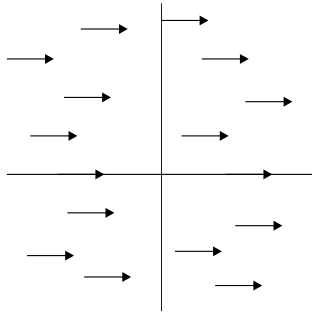

Example 14.0.6. The figure below is an example of a continuous vector field which is not smooth.

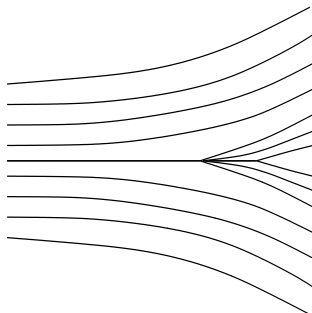

Suppose that v has an isolated zero $z \in U$. Define $\bar{V}: S_\epsilon \rightarrow S^{n-1}$ by

$$\bar{V}(x) = \frac{v(x)}{\|v(x)\|},$$

where $\epsilon > 0$ is such that z is the only zero in $\{x: |x - z| < \epsilon\}$.

Definition 14.0.2. The *index* of the vector field v at z is defined to be

$$\text{Ind}_z(v) := \deg \bar{V}.$$

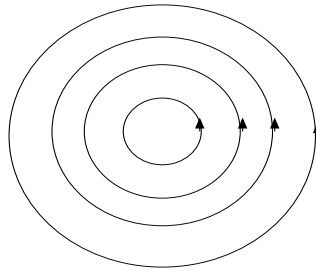

Index = +1

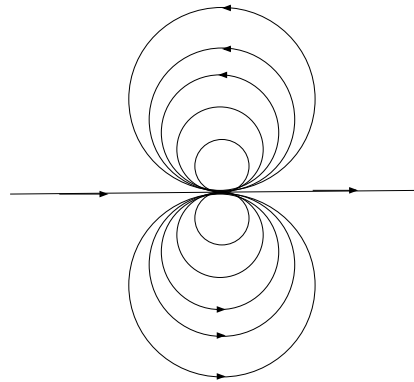

Index = +2

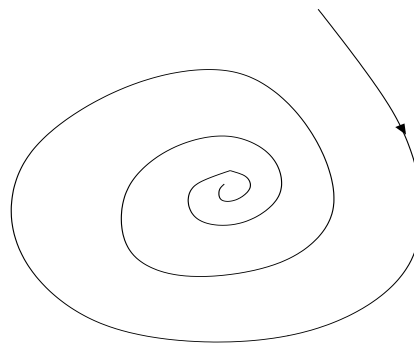

Index = +1

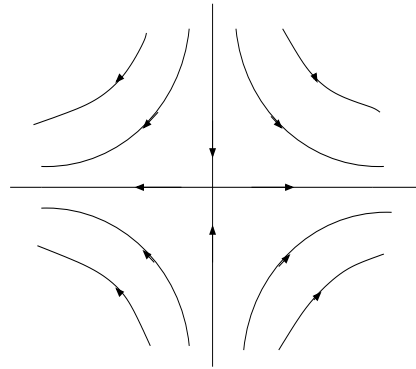

Index = -1

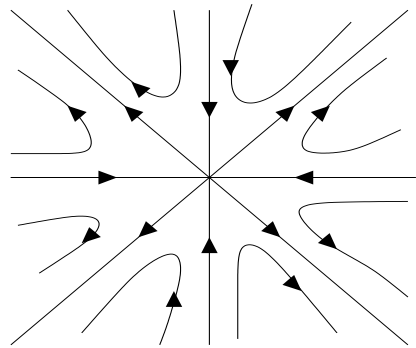

index= -2

Theorem 14.0.2 (Poincaré–Hopf). *Let M be a closed, oriented manifold. Then for every vector field with isolated zeroes the sum of all the indices is independent of the vector field. The value is the Euler characteristic of M and is denoted $\chi(M)$.*

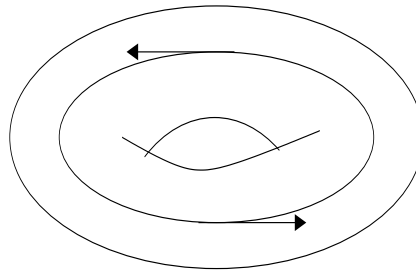

$$\chi(T^2) = 0$$

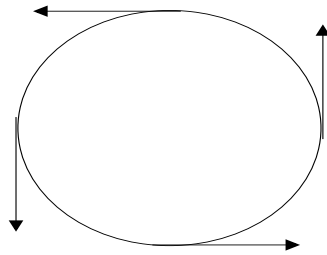

$$\chi(S^1) = 0$$

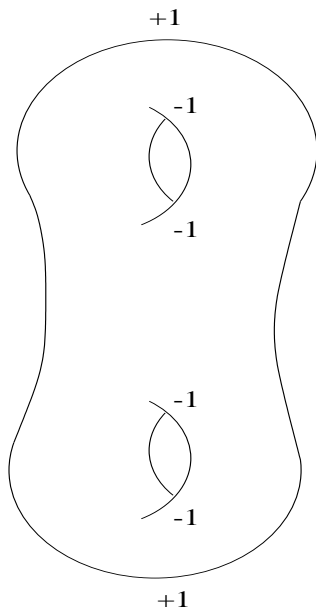

$$\chi(\Sigma_2) = -2$$

In general $\chi(\Sigma_g) = 2 - 2g$.

Definition 14.0.3. Let $f: M \rightarrow \mathbb{R}$ be a smooth function. Then $df_x: T_x(M) \rightarrow \mathbb{R}$ is a linear functional. The gradient vector field of f is the vector v such that $df_x(w) = \langle v, w \rangle$. We denote v by $\text{grad}_x(f)$.

Example 14.0.7. Let $f: \mathbb{R}^n \rightarrow \mathbb{R}$ be a smooth function. Then $\text{grad}(f) = \left(\frac{\partial f}{\partial x_1}, \dots, \frac{\partial f}{\partial x_n} \right)$.

Definition 14.0.4. Two maps $f, g: X \rightarrow Y$ are said to be *isotopic* if, and only if, there is a homotopy $F: X \times [0, 1] \rightarrow Y$ between f and g such that every $F_t: X \rightarrow Y$ is a diffeomorphism.

Lemma 14.0.2. *Every orientation preserving diffeomorphism $f: \mathbb{R}^m \longrightarrow \mathbb{R}^m$, is isotopic to the identity.*

Proof. Without loss of generality we can assume $f(0) = 0$. Now define $F: \mathbb{R}^m \times [0, 1] \longrightarrow \mathbb{R}^m$ by

$$F(x, t) = \begin{cases} \frac{f(tx)}{t}, & t > 0, \\ df_0(x), & t = 0. \end{cases}$$

It is clear that F is a diffeomorphism for each t . Now we need to argue that F is smooth. We can write f as $f(x) = x_1g_1(x) + x_2g_2(x) + \cdots + x_mg_m(x)$. Hence

$$\frac{f(tx)}{t} = \frac{x_1g_1(tx) + x_2g_2(tx) + \cdots + x_mg_m(tx)}{t},$$

which is smooth. Hence F is an isotopy. We have a relationship between f and a orientation preserving linear isomorphism $df_0: \mathbb{R}^m \longrightarrow \mathbb{R}^m$, but df_0 and I are in the same component of $Gl_m(\mathbb{R})$. \square

Corollary 14.0.1. *The space $\text{Diff}(\mathbb{R}^n)$ of orientation preserving diffeomorphisms of \mathbb{R}^n is contractible.*

Lemma 14.0.3. *Let $f: U \longrightarrow U' \subseteq \mathbb{R}^m$ be a diffeomorphism, v a vector field on U and v' a vector field on U' with $v'(f(x)) = df_x(v(x))$. If $z \in U$ is an isolated zero of v , then $z' = f(z)$ is an isolated zero of v' , and $\text{Ind}_z(v) = \text{Ind}_{z'}(v')$.*

Proof. Without loss of generality we can assume that U is convex, $z = 0$ and $f(z) = 0$. First assume that f is orientation preserving. Now define $f_t: U \longrightarrow f_t(U)$ by

$$f_t(x) = \begin{cases} \frac{f(tx)}{t} & , t > 0 \\ df_0(x) & t = 0. \end{cases}$$

It is clear that $f_t: U \longrightarrow f_t(U)$ is a diffeomorphism for each t . We now define a vector field v_t on $f_t(U)$ by $v_t(f_t(x)) = d(f_t)(v(x))$. Obviously $v_1 = v'$ Now define $\bar{v}_t: S_\epsilon \longrightarrow S^{n-1}$ by $x \rightarrow \frac{v_t(x)}{\|v_t(x)\|}$.

Claim: There exists an $\epsilon > 0$ such that $f_t(U)$ contains the ϵ -ball around zero, for all $t \in [0, 1]$.

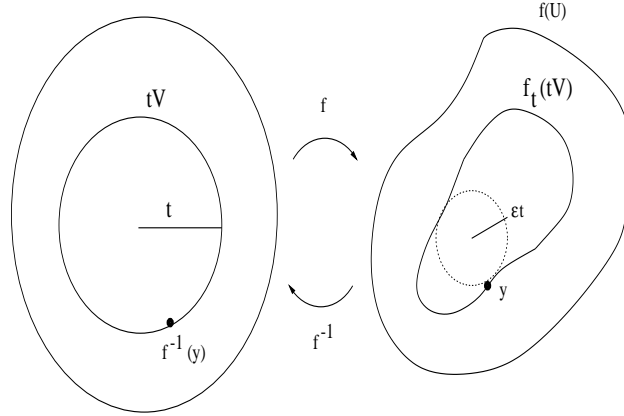

If no such ϵ exists, then there exists a $y \in f(U) - f_t(tV)$, with $\|y\| < 3t$ and $\|f^{-1}(y)\| = t$. But this violates the fact that f^{-1} is locally Lipschitz. So $\deg \bar{v}_t$ is constant, for all $t \in [0, 1]$. Therefore $\text{Ind}_{z'}(v') = \text{Ind}_0(v_1) = \text{Ind}_0(v_0)$. Since $df_0: \mathbb{R}^m \rightarrow \mathbb{R}^m$ is the same component as the identity in $GL_m(\mathbb{R})$, we can replace v_0 (which is obtained from v by transporting via df_0) by v (which is obtained from v by transporting via the identity). Hence $\text{Ind}_0(v_0) = \text{Ind}_0(v)$.

It now suffices to prove the lemma when $f = \rho$, a reflection. The matrix of ρ is given by

$$\begin{pmatrix} -1 & & & & \\ & 1 & & & \\ & & 1 & & \\ & & & \ddots & \\ & & & & 1 \end{pmatrix}.$$

Now $v'(\rho(x)) = d\rho(v(x))$, but $d\rho = \rho$. Hence $v'(\rho(x)) = \rho(v(x))$, which implies $v' = \rho \circ v \circ \rho^{-1}$. We then have $\bar{v}' = \bar{\rho} \bar{v} \bar{\rho}^{-1}$, which implies $\deg(\bar{v}') = \deg(\bar{v})$: because $\deg(\bar{\rho}) = -1$. \square

Corollary 14.0.2. *If df_0 is an isomorphism, and v is defined in a neighbourhood of zero by $v(x) = f(x)$, then $\text{Ind}_0(v) = \text{sign}(\det(df_0))$.*

Definition 14.0.5. Let v be a vector field on M . If $z \in M$ is an isolated zero, then we define the index of v at z to be

$$\text{Ind}_z(v) := \text{Ind}'_z(v'),$$

where v' is the vector field on $\phi(U)$ induced by the chart $\phi: U \rightarrow \phi(U)$, with $z \in U$ and $\phi(z) = z'$.

Lemma 14.0.4 (Hopf Lemma). *Let $X \subset \mathbb{R}^n$ be a m -dimensional compact manifold, and let $g: \partial X \rightarrow S^{n-1}$ be the Gauss map (that is $g(x) = n(x)$, the outward normal at x). Suppose v is a vector field on X which is outward pointing along ∂X ($v(x) \cdot g(x) > 0$). If v has isolated zeroes, then the sum of all the indices equals the degree of the Gauss map.*

Proof. First remove a small ball B_i around each zero of v .

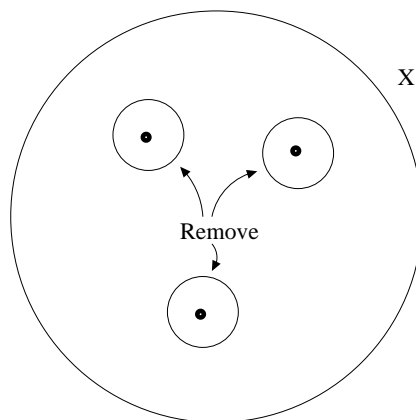

Now define $\bar{v}: X - \cup B_i \rightarrow S^{m-1}$ to be the function $x \rightarrow \frac{v(x)}{\|v(x)\|}$. By the boundary theorem $\deg(\bar{v}|_{\partial(X - \cup B_i)}) = 0$, which implies

$$\deg(g) - \sum_i \deg(\bar{v}_i: \partial B_i \rightarrow S^{m-1}) = 0,$$

because ∂B_i has the opposite orientation to X determined by outward normal convention vector orientation on X . \square

Theorem 14.0.3. *Let $M \subset \mathbb{R}^n$ be a closed manifold, and let v be a vector field on M with isolated zeros. Then the sum of all the indices equals the degree of the Gauss map on the ϵ -neighbourhood of M .*

Proof. Extend v to a vector field w on $N(\epsilon)$ by $w(x) = x - r(x) + v(r(x))$. If $x \in \partial N_\epsilon$ then $w(x) \cdot (x - r(x)) = \|x - r(x)\|^2 > 0$.

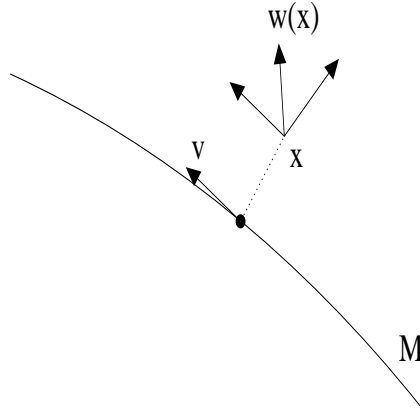

So w is outward pointing. We can now apply the Hopf lemma, which implies that the degree of the Gauss map for $N(\epsilon)$ is the sum of all the indices of w . Notice that the zeros of w and v are the same (and $w = v$ on M). Let z be a zero, then $dw_z(h) = dv_z(h)$ if $h \in T_z(M)$: because $w = v$ on M . Also, $dw_z(h) = h$ if $h \in T_z(M)^\perp$: because $w = id + \text{constant}$ on normal disk. Therefore dw_z is the matrix:

$$\begin{pmatrix} dv_z & 0 \\ 0 & I \end{pmatrix}.$$

Hence $\text{sign}(\det(dw_z)) = \text{sign}(\det(dv_z))$. So the sum of the indices are the same. \square

Proposition 14.0.2. *Let M be a closed, connected oriented manifold, and*

$$f: M \longrightarrow \mathbb{R}$$

a Morse function. Then $\text{grad}(f)$ is a vector field with nondegenerate isolated zeros and the index at a critical point of Morse index λ is $(-1)^\lambda$. If f has C_λ critical points of index λ , then $\chi(M) = C_0 - C_1 + C_2 - \dots$

This enables us to define the Euler characteristic of a closed manifold.

Definition 14.0.6. Let M be a closed manifold, and $f: M \longrightarrow \mathbb{R}$ be a Morse function. Then the Euler characteristic of M is defined to be

$$\chi(M) = C_0 - C_1 + C_2 - \dots,$$

where C_λ is the number of critical points of index λ .

Example 14.0.8. By considering the Morse function $f: S^n \rightarrow \mathbb{R}$ given by $f(x_0, \dots, x_n) = x_n$, we have the following result:

$$\chi(S^n) = \begin{cases} 0 & \text{if } n \text{ is odd,} \\ 2 & \text{if } n \text{ is even.} \end{cases}$$

Example 14.0.9. Suppose we have a Morse function $f: \mathbb{R}P^n \rightarrow \mathbb{R}$ this then induces a Morse function $f': S^n \rightarrow \mathbb{R}$, which has twice the number of critical points. If $x \in S^n$ is a critical point of index λ , then $\pi(x)$ is a critical point of f of index λ .

$$\begin{array}{ccc} S^n & & \\ \downarrow \pi & & \\ \mathbb{R}P^n & \xrightarrow{f(\text{morse})} & \mathbb{R} \end{array}$$

Hence

$$\chi(\mathbb{R}P^n) = \frac{1}{2}\chi(S^n) = \begin{cases} 0 & \text{if } n \text{ is odd,} \\ 1 & \text{if } n \text{ is even.} \end{cases}$$

Proposition 14.0.3. *The Euler characteristic of an odd dimensional closed manifold M is zero.*

Proof. Let $f: M \rightarrow \mathbb{R}$ be a Morse function. Then $-f: M \rightarrow \mathbb{R}$ is also a Morse function. Now if $p \in M$ is a critical point of f with index λ , then p is a critical point of $-f$ with index $n - \lambda$. Therefore

$$\chi(M) = \sum (-1)^\lambda C_\lambda = \sum (-1)^{n-\lambda} C_\lambda.$$

The two sums differ by a multiple of -1 . Therefore $\chi(M) = 0$. □

14.1 Algebraic Curves

Fix an integer $d > 0$ and consider the equation

$$x^d + y^d + z^d = 0.$$

This defines a certain set \tilde{C} in \mathbb{C}^3 . Notice that this set is invariant under scaling by $\lambda \in \mathbb{C} - \{0\}$. Thus \tilde{C} determines a subset $C \subset \mathbb{C}P^2$, known as an *algebraic curve* (of degree d).

1. Show that C is a submanifold of $\mathbb{C}P^2$ of dimension 2.

2. Show that C is connected.

We would like to compute the genus g of C . Recalling the formula $\chi(C) = 2 - 2g$, the strategy is to compute $\chi(C)$ using the Poincaré–Hopf. It will be convenient to work in the chart $z = 1$ of $\mathbb{C}P^2$. The complement of this chart is the set where $z = 0$ (a copy of $\mathbb{C}P^1 = S^2$).

3. Show that C and $\{z = 0\}$ intersect transversely in d points p_1, \dots, p_d . More generally, show that $\{x^d + y^d + tz^d\}$ is a submanifold for any $t \neq 0$ and that it intersects $\{z = 0\}$ transversely in the *same* d points.

Now consider the map $f: \mathbb{C}^2 \rightarrow \mathbb{C}$ given by $f(z, y) = x^d + y^d$.

4. Show that 0 is the only critical point of f . Also, show that $f^{-1}(0)$ is the union of d lines (i.e., planes!) through 0.
5. Define a vector field $v: \mathbb{C}^2 \rightarrow \mathbb{C}^2$ by $v(x, y) = (-y^{d-1}, x^{d-1})$. Show that v is tangent to the level sets of f at all points (except 0, where $f^{-1}(0)$ is not a manifold).

We are now in good shape. We have a vector field on $f^{-1}(-1)$ that does not have any zeroes! We only need to figure out the indices at the d points of $C = f^{-1}(-1)$. To get a better feeling about v at these points, let us first consider the simpler case of one of the lines $L \cong \mathbb{C}$ in $f^{-1}(0)$.

6. Show that v has only one zero on L , namely at 0, and compute its index.
7. When a point is added to L it becomes diffeomorphic to $\mathbb{C}P^1$. Which point? If v could be extended to $\mathbb{C}P^1$ what would its index have to be at the added point? Use Poincaré–Hopf and the fact that $\chi(S^2) = 2$.

Unfortunately, v does not extend (continuously) to the added point. It "blows up", i.e., the norms of nearby vectors go to infinity. It behaves like the function $z \rightarrow \frac{1}{z^m}$ near 0.

The good news is that we can talk about the index of a vector field v at a singular point where v is perhaps not even defined at p . (but is defined and nonzero at all other points of some neighbourhood of p). The definition is exactly the same as before.

8. Using the technology of bump functions show that there is another vector field v' that agrees with v outside a neighbourhood of p , it is a scalar multiple of v at all points other than p , it is defined and 0 at p , and $\text{Ind}_p(v') = \text{Ind}_p(v)$. Deduce the Poincaré–Hopf theorem holds for these more general singular vector fields.

9. Show that the index of v at p_i on $\{x^d + y^d + tz^d = 0\}$ is independent of t and it equals the index of v at p_i on the appropriate $\mathbb{C}P^1$ in $\{x^d + y^d = 0\}$. Hint: Use the fact that homotopic maps have equal degrees. You will need to provide a continuously varying collection of circles, one for each t , used to compute the index. You do not have to give a formula for these circles, just an argument that they exist (use the inverse function theorem).
10. Use the Poincaré–Hopf theorem to express $\chi(C)$ in terms of d . Compute the genus.

With luck, you got

$$g = \frac{(d-1)(d-2)}{2}.$$

Exercises

1. Let f and g be Morse functions on the closed manifolds M and N . Show that the function $h: M \times N \rightarrow \mathbb{R}$ given by

$$h(p, q) = f(p) + g(q)$$

is a Morse function. Derive the product formula for the Euler characteristics

$$\chi(M \times N) = \chi(M)\chi(N).$$

2. Let $f: X \rightarrow Y$ be a smooth map of smooth, compact, connected oriented manifolds of the same dimension, and suppose that f is everywhere a submersion.

(a) Prove that *either* for all $x \in X$, df_x preserves orientation *or*, for all $x \in X$, df_x reverses orientation.

(b) Prove that

$$\chi(X) = |\deg(f)|\chi(Y).$$

15 Group Actions and Lie Groups

Definition 15.0.1. Let G be a group and X a set. We say G acts on X if we have a map

$$\begin{aligned} G \times X &\longrightarrow X \\ (g, x) &\longmapsto g \cdot x \end{aligned}$$

such that the following hold:

$$(1) 1 \cdot x = x \text{ for all } x \in X.$$

$$(2) (g_1 \cdot g_2) \cdot x = g_1 \cdot (g_2 \cdot x).$$

We are going to look at the cases where X and G are both manifolds, and the group action is smooth (that just means that the map above is smooth).

Example 15.0.1. The trivial group action is given by $(g, x) \rightarrow x$ for all $g \in G, x \in X$.

Example 15.0.2. The group $Gl_n(\mathbb{R})$ acts on \mathbb{R}^n in the following way:

$$A \cdot x \rightarrow Ax.$$

This action is smooth since the map $Gl_n(\mathbb{R}) \times \mathbb{R}^n \rightarrow \mathbb{R}^n$ is just given by polynomials in the entries of $A \in Gl_n(\mathbb{R})$ and $x \in \mathbb{R}^n$.

15.1 Complex Projective Space

Example 15.1.1. S^1 acts on S^{2n+1} in the following way:

$$t(z_0, z_1, \dots, z_n) = (tz_0, tz_1, \dots, tz_n).$$

Complex Projective Space as a set, is the set of orbits under this group action:

$$(z_0, z_1, \dots, z_n) \sim (tz_0, tz_1, \dots, tz_n).$$

Homogeneous coordinates: Denote $[z_0 : z_1 : \dots : z_n]$ to be the equivalence class of (z_0, z_1, \dots, z_n) . We can cover $\mathbb{C}P^n$ by open sets

$$U_i = \{[z_0 : z_1 : \dots : z_n] : z_i \neq 0\}.$$

Now define $\phi_i: U_i \rightarrow \mathbb{C}^n$ by

$$\phi_i([z_0 : z_1 : \dots : z_n]) = \left(\frac{z_0}{z_i}, \dots, \frac{z_{i-1}}{z_i}, \frac{z_{i+1}}{z_i}, \dots, \frac{z_n}{z_i} \right).$$

The reader can verify that the transition functions are smooth (they are actually analytic). Hence $\mathbb{C}P^n$ is a complex manifold. We have a map $\pi: S^{2n+1} \rightarrow \mathbb{C}P^n$ defined by

$$\pi(z_0, z_1, \dots, z_n) = [z_0 : z_1 : \dots : z_n].$$

For the case $n = 1$, we have the famous *Hopf map*. Notice that the preimage of a point in $\mathbb{C}P^n$ is S^1 .

Now to calculate $\chi(\mathbb{C}P^n)$.

We have an action of S^1 on $\mathbb{C}P^n$ given by

$$t \cdot [z_0 : z_1 : \dots : z_n] = [z_0 : tz_1 : \dots : t^n z_n].$$

This action is well-defined and smooth. We shall consider the open set U_0 . Let V be the vector field on $\mathbb{C}P^n$ which is the velocity at $t = 1$. So if $w \in \mathbb{C}P^n$ there exists a map $S^1 \rightarrow \mathbb{C}P^n$ given by $t \rightarrow t \cdot w$. We now calculate in U_0 , which is diffeomorphic to \mathbb{C}^n . The action is $t \cdot (z_1, z_2, \dots, z_n) = (tz_1, t^2 z_2, \dots, t^n z_n)$. If $n = 1$, then the orbits under this action are concentric circles except the origin, which is a fixed point of this action. We have

$$\left. \frac{d}{dt}(tz_1, t^2 z_2, \dots, t^n z_n) \right|_{t=1} = (z_1, 2z_2, 3z_3, \dots, nz_n) \neq 0 \quad \text{except at zero.}$$

The index of this vector field can be found by looking at the sign of the determinant of the following matrix:

$$\begin{pmatrix} 1 & & & & \\ & 2 & & & \\ & & 3 & & \\ & & & \ddots & \\ & & & & n \end{pmatrix}.$$

The determinant of this matrix is positive, so $\text{Ind}_0(v) = +1$, zero corresponds to the point $[1 : 0 : \dots : 0] \in \mathbb{C}P^n$.

We now calculate in the chart $U_1 \cong \mathbb{C}^n = \{(z_0, z_2, \dots, z_n)\}$. Now S^1 acts on U_1 in the following way:

$$\begin{aligned} t[z_0 : 1 : z_2 : \dots : z_n] &= [z_0 : t : t^2 z_2 : \dots : t^n z_n] \\ &= [z_0 t^{-1} : 1 : t z_2 : \dots : t^{n-1} z_n]. \end{aligned}$$

Hence $t(z_0, z_2, \dots, z_n) = (z_0 t^{-1}, tz_2, \dots, t^{n-1} z_n)$. Therefore

$$\left. \frac{d}{dt}(z_0 t^{-1}, tz_2, \dots, t^{n-1} z_n) \right|_{t=1} = (-z_0, z_2, \dots, (n-1)z_n).$$

This tells us that $[0 : 1 : \dots : 0]$ is the only zero. The index at this point can be found by computing the sign of the determinant of the following matrix:

$$\begin{pmatrix} -1 & & & & & \\ & 1 & & & & \\ & & 2 & & & \\ & & & \ddots & & \\ & & & & \ddots & \\ & & & & & n-1 \end{pmatrix}.$$

The determinant of this matrix is positive since we are in \mathbb{C} . Repeating the same process in each chart we obtain: $\chi(\mathbb{C}P^n) = n + 1$.

Example 15.1.2. The Euler characteristic of S^2 is 2, since $S^2 \cong \mathbb{C}P^1$.

Theorem 15.1.1. *Let M be a closed and connected manifold. Then M has a nowhere vanishing vector field if, and only if, the Euler characteristic is zero.*

Example 15.1.3. Let A be an element of $O(n)$. We know that $T_I(O(n))$ is the set of anti-symmetric matrices and that $T_A(O(n)) = \{B \in M_{n \times n} : BA^T + AB^T = 0\}$. Now pick some nonzero element $B \in T_I(O(n))$, then the matrix AB is in $T_A(O(n))$. This allows us to construct a vector field on $O(n)$ with no zeros. The vector field $X: O(n) \rightarrow T(O(n))$ is given by $X(A) = (A, AB)$. Therefore the Euler characteristic of $O(n)$ is zero.

We shall show later that all compact Lie groups have zero Euler characteristic.

Exercises

1. Which closed orientable surfaces have trivial tangent bundle.
2. Suppose that G is a connected topological space, which is also a group, and X is a discrete topological space. Show that any continuous action of G on X has to be the trivial action.
3. Let G be a topological space, which is also a group. Then G is said to be a topological group if the map

$$\begin{aligned} G \times G &\longrightarrow G \\ (g, h) &\longrightarrow gh^{-1} \end{aligned}$$

is continuous. Let H be a discrete normal subgroup of a topological group G . Show that H is contained in the centre of G .

4. Let c_0, \dots, c_n be distinct real numbers. Define $f: \mathbb{C}P^n \rightarrow \mathbb{R}$ by

$$f([z_0 : \dots : z_n]) = \sum_{i=0}^n c_i |z_i|^2.$$

Show that f is a Morse function. Hint: First work in the following coordinate system $U_0 = \{[z_0 : \dots : z_n] : z_0 \neq 0\}$ and set $|z_0| \frac{z_j}{z_0} = x_j + iy_j$. What is f in this coordinate neighbourhood U_0 . Now work in the other coordinate neighbourhoods U_i .

5. \mathbb{Z}_2 acts on $S^1 \times S^1$ in the following way:

$$1 \cdot (x, y) \rightarrow (x, y), \quad -1 \cdot (x, y) \rightarrow (y, x)$$

We use the notation $S^1 \times S^1 / \mathbb{Z}_2$ to mean $S^1 \times S^1 / \sim$ where two points are equivalent if they lie in the same orbit. What manifold is $S^1 \times S^1 / \mathbb{Z}_2$?

15.2 Lie Groups

Definition 15.2.1. Let G be a group. We say G is a *Lie group*, if it is a smooth manifold and the following group operations are smooth maps:

(1) The map $G \times G \rightarrow G$ given $(g, h) \rightarrow gh$,

(2) The map $G \rightarrow G$ given by $g \rightarrow g^{-1}$.

Example 15.2.1. \mathbb{R}^n under the group operation of addition is a Lie group.

Lemma 15.2.1. *Let G be a group and a manifold. If the multiplication map given by*

$$(g, h) \rightarrow gh$$

is smooth, then G is a Lie group.

Example 15.2.2. If we give the group \mathbb{Z} the discrete topology, then it becomes a zero dimensional manifold. Hence \mathbb{Z} is a Lie group. Moreover, any finite group or countable group with the discrete topology is a zero dimensional Lie group.

Example 15.2.3. $Gl_n(\mathbb{R})$, as well as $0(n)$ and $Sl_n(\mathbb{R})$, under the group operation of matrix multiplication are Lie groups.

Example 15.2.4. We can identify S^1 with the set of complex numbers of unit length, that is $S^1 = \{z \in \mathbb{C}: |z| = 1\}$. We can then define a group operation on S^1 by defining the operation to be multiplication of complex numbers. You can check that this operation is smooth. Hence S^1 is a Lie Group, under this operation.

Lemma 15.2.2. *Let G_1 and G_2 both be Lie groups. Then $G_1 \times G_2$ is a Lie group.*

Example 15.2.5. The preceding lemma shows that $T^n = S^1 \times \dots \times S^1$ is a Lie Group.

Example 15.2.6. The *quaternion algebra* is the real vector space with basis $\{1, i, j, k\}$ with multiplication defined by the following rules:

$$i^2 = j^2 = k^2 = -1, \quad ij = k, \quad jk = i, \quad ki = j.$$

This algebra is non-commutative since $ji = -k$. It is associative, however. One can check that the quaternions form a division algebra. Thus the elements of norm 1 form a multiplicative subgroup whose elements comprise of the unit sphere. The group operations are smooth, hence S^3 is a Lie group, called the group of unit quaternions.

It is a fact that the only spheres of positive dimension that are Lie groups are S^1 and S^3 .

Example 15.2.7. The *Heisenberg group* H consists of the matrices

$$\begin{pmatrix} 1 & x & z \\ 0 & 1 & y \\ 0 & 0 & 1 \end{pmatrix},$$

where $x, y, z \in \mathbb{R}$. H is clearly diffeomorphic to \mathbb{R}^3 and you can check that the group multiplication is also smooth. Hence H is a lie group.

Definition 15.2.2. Let $f: G_1 \rightarrow G_2$ be a map between two Lie groups. Then f is a homomorphism (of Lie groups) if f is both a homomorphism of groups and smooth.

Example 15.2.8. The map $\det: Gl_n(\mathbb{R}) \rightarrow \mathbb{R}$ given by $A \rightarrow \det(A)$ is a homomorphism of Lie groups.

Example 15.2.9. The map $p: \mathbb{R} \rightarrow S^1$ given by $p(t) = e^{2\pi it}$ is a homomorphism of Lie groups.

Theorem 15.2.1. *Any closed and connected Lie group G of positive dimension has Euler characteristic zero.*

Proof. Let v be a nonzero element of $T_e(G)$. The map $g: G \rightarrow G$ given by $h \rightarrow gh$ is a diffeomorphism, hence the map $dg_e: T_e(G) \rightarrow T_g(G)$ is an isomorphism. Therefore the vector $dg_e(v)$ is a nonzero vector of $T_g(G)$. The vector field $X: G \rightarrow TG$ given by $X(g) = (g, dg_e(v))$ is thus a nonzero vector field. \square

Exercises

1. Show that $Gl_n(\mathbb{R})$ is a Lie group.
2. Show that the tangent bundle of a Lie group can be made into a Lie group.
3. Show that the torus is the only closed, connected orientable surface which is a Lie group.
4. Show that even dimensional spheres cannot be Lie groups, except for S^0 .
5. Show that all Lie groups are parallelizable, and hence orientable.
6. Show that the fundamental group of a Lie group is abelian, actually the fundamental group of a topological group is abelian.
7. Let Γ be a group. Suppose Γ' is a group obtained from γ by adding one more generator x and a relation r . Also, assume that the exponent sum of the powers of x occurring in r is one. Suppose that γ admits a faithful representation into a compact, connected Lie group, that is, a injective homomorphism

$$\rho: \gamma \rightarrow G.$$

Then the inclusion map $\Gamma \rightarrow \Gamma'$ is injective. (Hint: Let

$$r = \gamma_1 x^{k_1} \gamma_2 x^{k_2} \dots \gamma_m x^{k_m},$$

where $k_1 + \dots + k_m = 1$. Now define a map $f: G \rightarrow G$ by $f(h) = \gamma_1 h^{k_1} \gamma_2 h^{k_2} \dots \gamma_m h^{k_m}$. Show that f is homotopic to the identity. Now finish off the proof.

8. Show that every nonconstant polynomial over the quaternions has a root.

Definition 15.2.3. A (Lie) subgroup H of a Lie group G will mean any subgroup which is a submanifold and is a Lie group with its smooth structure as an (immersed) submanifold.

15.3 Fibre Bundles

Definition 15.3.1. Let E, B and F be topological spaces and $\pi: E \rightarrow B$ a continuous map. We say $\pi: E \rightarrow B$ is a *fibre bundle* if it satisfies the following condition: For each point $b \in B$ there is an open neighborhood U_b and a homeomorphism

$$h: U_b \times F \rightarrow \pi^{-1}(U_b)$$

such that the $\pi \circ h = \text{proj}$. We also denote this fibre bundle by

$$F \rightarrow E \rightarrow B$$

If F is a discrete space, then the fibre bundle is a covering space. We are only going to be interested in the case where all the spaces are smooth manifolds (possibly with boundary).

Example 15.3.1. The standard example is the product fibre bundle, that is, $E = F \times B$ and the map π is just projection onto B .

Example 15.3.2. Let E be the Möbius band, B the circle and $F = [0, 1]$.

Example 15.3.3. Let E be the Klein bottle, $B = S^1$ and $F = S^1$.

Example 15.3.4. S_g is used to denote a surface of genus g . Let E be obtained by taking $S_g \times I$ and glueing $S_g \times \{0\}$ to $S_g \times \{1\}$ via orientation preserving map. Then E is a orientable 3-manifold which fibres over the circle.

Lemma 15.3.1. Let G be a Lie group with H and K closed subgroups of G with $K \subset H$. Then we have a fibre bundle $\pi: G/K \rightarrow G/H$, where π is the quotient map. The fibres may be identified with the coset H/K .

Example 15.3.5. Consider the Lie group $G = SO(3)$ and the closed subgroups $H = SO(2)$ and $K = \{1\}$. Then we have the fibre bundle

$$S^1 = SO(2) \rightarrow SO(3) \rightarrow S^2 = SO(3)/SO(2)$$

Theorem 15.3.1. Let $p: E \rightarrow B$ be a surjective submersion between closed manifolds. Then $p: E \rightarrow B$ is a fibre bundle.

Proof. Let $b \in B$, then $p^{-1}(b)$ is a closed submanifold of E . Let N be an ϵ -neighbourhood of M , and choose U_b so that $p^{-1}(U_b) \subset N$. The map $h: U_b \times p^{-1}(b) \rightarrow p^{-1}(U_b)$ is given by $h(b_1, x) = r_{b_1}^{-1}(x)$, where the map $r_{b_1}: p^{-1}(b_1) \rightarrow p^{-1}(b)$ is the closest point retraction. \square

15.4 Actions of Lie Groups

Definition 15.4.1. Let a group G act on a set X . The *orbit* of $x \in X$ is $Gx := \{gx : g \in G\}$. If $Gx = x$, then x is fixed point of G . The action is said to be *transitive* if $Gx = X$ for some $x \in X$.

Example 15.4.1. We saw earlier that $Gl_n(\mathbb{R})$ acts on \mathbb{R}^n . The origin is a fixed point of this action and $Gl_n(\mathbb{R})$ acts transitively on $\mathbb{R}^n - \{0\}$. For suppose $x = (x_1, x_2, \dots, x_n) \neq 0$, then we can choose a basis $\{f_1, f_2, \dots, f_n\}$ such that $x = f_1$. Now we can find a linear map taking the standard basis $\{e_1, e_2, \dots, e_n\}$ to the basis $\{f_1, f_2, \dots, f_n\}$. If we let A be the corresponding matrix of this linear map then $Ae_1 = f_1 = x$. Therefore every element $x \neq 0$ is in the orbit of e_1 .

Example 15.4.2. The group $O(n)$ is a subgroup of $Gl_n(\mathbb{R})$ so restricting the action of $Gl_n(\mathbb{R})$ on \mathbb{R}^n to $O(n)$ we get an action of $O(n)$ on \mathbb{R}^n . The orbits are concentric spheres with the origin as a fixed point.

Definition 15.4.2. Let G be a group acting on a set X , and let $x \in X$. The *isotropy* group of x , denoted G_x , is defined to be $G_x := \{g \in G : gx = x\}$. The group G is said to act *freely* on X if $gx = x$ implies $g = 1$.

Example 15.4.3. The group $O(2)$ acts on S^1 by rotations. An action of $O(2)$ on $\mathbb{R}P^1$ is given by $A \cdot [x] \rightarrow [Ax]$. The isotropy subgroup of $[1 : 0]$ consists of the two matrices

$$\begin{pmatrix} 1 & 0 \\ 0 & 1 \end{pmatrix} \quad \text{and} \quad \begin{pmatrix} -1 & 0 \\ 0 & -1 \end{pmatrix}.$$

Hence the isotropy subgroup of the point $[1 : 0]$ is isomorphic to \mathbb{Z}_2 .

15.5 Discrete Group Actions

Definition 15.5.1. A *discrete group* is a group with the discrete topology.

Example 15.5.1. Any finite group is a discrete group.

Example 15.5.2. The group \mathbb{Z}^n with the subspace topology of \mathbb{R}^n is a discrete group.

Definition 15.5.2. A discrete group Γ is said to act *properly discontinuously* on a manifold M if the action is smooth and satisfies the following two conditions:

(1) Each $x \in M$ has a neighbourhood U such that the set $\{\gamma \in \Gamma: \gamma U \cap U \neq \emptyset\}$ is finite.

(2) If $x, y \in M$ are not in the same orbit, then there are neighbourhoods U, V of x, y such that $U \cap \Gamma V = \emptyset$.

Example 15.5.3. The group \mathbb{Z}_2 acts on S^n by sending 1 to the identity map and -1 to the antipodal map. One can check that this action is free and properly discontinuous. The quotient space under this action is none other than $\mathbb{R}P^n$.

Definition 15.5.3. Let $\pi: \tilde{M} \rightarrow M$ be a smooth mapping between manifolds of the same dimension. Then \tilde{M} is said to be a covering manifold with covering map π if π is onto, \tilde{M} is connected and if each $p \in M$ has a connected neighbourhood U such that $\pi^{-1}(U) = \cup U_i$, a union of open components U_i , with the property that π restricted to each U_i is a diffeomorphism onto U . The U are called *admissible* neighbourhoods and π is called the covering mapping.

Example 15.5.4. The map $\pi: \mathbb{R} \rightarrow S^1$ given by $t \rightarrow e^{2\pi it}$ is a covering map, hence \mathbb{R} is a covering manifold of S^1 .

Example 15.5.5. The map $\pi: S^n \rightarrow \mathbb{R}P^n$ given by $x \rightarrow [x]$ is a covering map, hence S^n is a covering manifold of $\mathbb{R}P^n$.

Theorem 15.5.1. *Let M be a manifold. Then there exists a simply-connected manifold \tilde{M} which covers M . \tilde{M} is called the universal cover.*

Given an action of a group Γ on a manifold M we can define an equivalence relation on M in the following way: Two elements are equivalent if they lie in the same orbit. We can then form the quotient space, which we denote M/Γ . This space is given the quotient topology.

Example 15.5.6. We saw earlier that $O(n)$ acts on \mathbb{R}^n and the orbits are concentric spheres with the origin a fixed point. Therefore $\mathbb{R}^n/O(n)$ is homeomorphic to $\{x \in \mathbb{R}: x \geq 0\}$.

The natural question that arises is: Given a group action of a group Γ on a manifold M what conditions are needed for M/Γ to be a manifold.

Theorem 15.5.2. *Let Γ be a discrete group which acts freely and properly discontinuously on a manifold M . Then there is a unique smooth structure on M/G such that the quotient map $\pi: M \rightarrow M/G$ is a covering map.*

Proposition 15.5.1. *The group \mathbb{Z}_2 is the only nontrivial group that can freely on even dimensional spheres*

Proof. Let G be a group which acts freely on S^{2n} . Then each nontrivial element of G gives rise to a homeomorphism on S^{2n} , hence the degree of this homeomorphism must be $(-1)^{2n+1} = -1$. The degree function is a homomorphism from G to \mathbb{Z}_2 and by the previous sentence it is injective. Therefore $G = \mathbb{Z}_2$ if G is a nontrivial group. \square

Example 15.5.7. The group \mathbb{Z}^n acts on \mathbb{R}^n in the obvious way and the quotient space is the n -dimensional torus T^n .

Example 15.5.8. The manifold \mathbb{R}^n is a covering manifold of T^n and the covering map is $x \rightarrow [x]$.

Theorem 15.5.3. *Any discrete subgroup Γ of a Lie group G acts freely and properly discontinuously on G by left translation.*

Example 15.5.9. The group \mathbb{Z} is a discrete subgroup of \mathbb{R} and it acts freely and properly discontinuously on \mathbb{R} by left translations and the quotient space is S^1 .

Corollary 15.5.1. *If Γ is a discrete subgroup of a Lie group G , then G/Γ is a smooth manifold and the quotient map $\pi: G \rightarrow G/\Gamma$ is smooth.*

Exercises

1. Let H be a nontrivial discrete subgroup of \mathbb{R}^n , show that H is isomorphic to \mathbb{Z}^m for some $m \leq n$.

15.6 Lie Groups as Riemannian Manifolds

It would be nice to have Riemannian metrics on Lie groups for which left and right multiplication are isometries. If we look for metrics that so that left multiplication are isometries then this is easy to do.

Theorem 15.6.1. *Let G be a Lie group with identity e . Pick any inner product $\langle \cdot, \cdot \rangle_e$ on the tangent space $T_e G$. Define*

$$g(U, V)_x = \langle U, V \rangle_x := \langle (L_{x^{-1}})_* U, (L_{x^{-1}})_* V \rangle_e \quad (*)$$

This defines a left-invariant metric on G , and every left-invariant metric has this property.

Definition 15.6.1. A vector field U is left-invariant if, and only if, $(L_x)_* U = U$ for all $x \in G$.

16 The Pontryagin Construction

Definition 16.0.2. Two closed submanifolds N and N' of a closed manifold M are *cobordant* if $N \times [0, \epsilon) \cup N' \times (1 - \epsilon, 1]$ can be extended to a neat submanifold X of $M \times [0, 1]$.

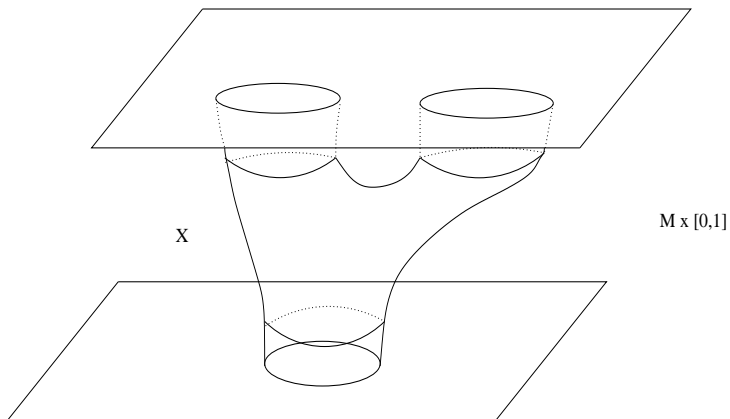

Definition 16.0.3 (h-Cobordism). An *h-cobordism* is a cobordism between two manifolds M_1 and M_2 such that the neat submanifold X is simply-connected and the inclusion maps $M_1 \rightarrow X$ and $M_2 \rightarrow X$ are homotopy equivalences.

Theorem 16.0.2 (h-Cobordism Theorem). *If X is a simply-connected, compact manifold with two boundary components M_1 and M_2 such that the inclusion of each is a homotopy equivalence, then X is diffeomorphic to the product $M_1 \times [0, 1]$ if $\dim(M_1) \geq 5$.*

Definition 16.0.4. A *framing* of $N \subset M$ is a trivialisation of the normal bundle of N , i.e., it is a tuple of smooth vector fields $\phi = (\phi_1, \dots, \phi_p)$ ($p = \text{codim}(N)$) along N such that every point of N forms a basis of the normal space.

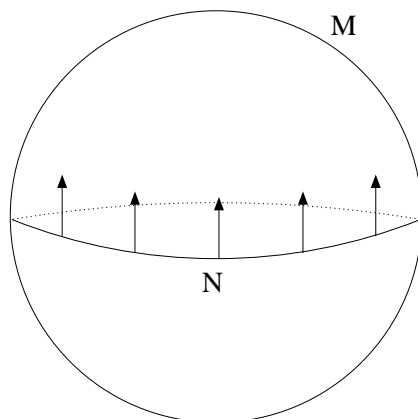

Definition 16.0.5. A *framed manifold* is a pair (N, ϕ) , where $N \subset M$ and ϕ is a framing of N .

Definition 16.0.6. Two framed manifolds (N, ϕ) and (N', ϕ') (N and N' are both submanifolds of a manifold M) are framed cobordant if there exists cobordisms $X \subset M \times [0, 1]$ between N and N' and there also exists a framing of X that extends ϕ and ϕ' .

Notice this gives us an equivalence relation.

Example 16.0.1. Let $M = T^2$, then the two framed manifolds as indicated below are framed cobordant.

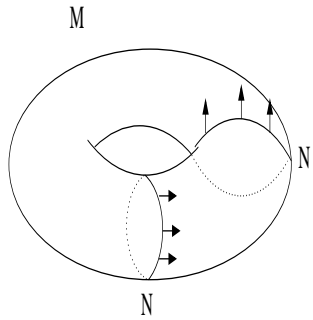

Suppose $f: M \rightarrow S^p$ is a smooth map with $y \in S^p$ a regular value and β is a positive basis of $T_y(S^p)$. If $x \in f^{-1}(y)$, then df_x maps $N_x(f^{-1}(y), M)$ isomorphically onto $T_y(S^p)$. This gives us a framing of $f^{-1}(y)$, which we denote $f^*(\beta)$.

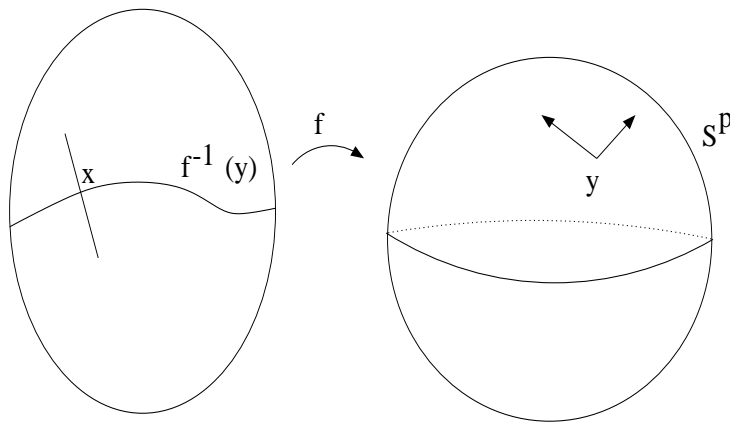

Definition 16.0.7. The pair $(f^{-1}(y), f^*(\beta))$ is called the Pontryagin framed manifold associated with f .

Lemma 16.0.1. Suppose β' is another positively oriented basis for $T_y(S^p)$. Then $(f^{-1}(y), f^*(\beta'))$ is framed cobordant to $(f^{-1}(y), f^*(\beta))$.

Proof. The space of positively oriented bases of $T_y(S^p)$ is path-connected. Thus, a path joining β to β' determines a framed cobordism between the two pairs $(f^{-1}(y), f^*(\beta))$ and $(f^{-1}(y), f^*(\beta'))$. \square

Hence, instead of writing $(f^{-1}(y), f^*(\beta))$ we shall just write $f^{-1}(y)$.

Lemma 16.0.2. *If y is a regular value of f , and z is sufficiently close to y , then $f^{-1}(z)$ is framed cobordant to $f^{-1}(y)$.*

Proof. The set of critical values is compact. So we choose a neighbourhood N of y that contains no critical values. Let $z \in N$. Then a path from z to y that stays in N defines a framed cobordism between $f^{-1}(z)$ and $f^{-1}(y)$. \square

Lemma 16.0.3. *If f and g are smoothly homotopic and y is a regular value for both f and g , then $f^{-1}(y)$ is framed cobordant to $g^{-1}(y)$.*

Proof. Let $H: M \times I \rightarrow S^p$ be a homotopy between f and g . We choose a regular value z of H sufficiently close to y . Then $H^{-1}(z)$ provides a framed cobordism between $f^{-1}(z)$ and $g^{-1}(z)$, and hence between $f^{-1}(y)$ and $g^{-1}(y)$. \square

Lemma 16.0.4. *If y and z are regular values for $f: M \rightarrow S^p$, then $f^{-1}(y)$ and $f^{-1}(z)$ are framed cobordant.*

Proof. Let $r_1: S^p \rightarrow S^p$ be a diffeomorphism such that $r_1(z) = y$ and r_1 is isotopic to the identity. Then f is isotopic to $r_1 \circ f$ and

$$(r_1 \circ f)^{-1}(y) = f^{-1}(r_1^{-1}(y)) = f^{-1}(z).$$

Therefore by the previous lemma we have the result. \square

Lemma 16.0.5. *Any framed submanifold of codimension p in M is framed cobordant to a Pontryagin framed submanifold for some mapping $f: M \rightarrow S^p$.*

Lemma 16.0.6. *Let $f: M \rightarrow S^p$ and $g: M \rightarrow S^p$ be two smooth maps, and let $y \in S^p$ be a regular value for both f and g . If $f^{-1}(y)$ and $g^{-1}(y)$ are framed cobordant, then f and g are smoothly homotopic.*

Theorem 16.0.3. *The Pontryagin construction is a bijection*

$$\left\{ \begin{array}{l} \text{Homotopy classes of smooth} \\ \text{maps } M \rightarrow S^p \end{array} \right\} \leftrightarrow \left\{ \begin{array}{l} \text{framed cobordism classes of framed} \\ \text{submanifolds of } M \text{ with } \text{codim} = p \end{array} \right\}$$

Examples:

Example 16.0.2. If $\dim M < p$, then the right hand side consists of the empty set. Hence the left hand side has only constants, i.e., every map $f: M \rightarrow S^p$ is null-homotopic.

Example 16.0.3. If $\dim M = p$, and M is also connected and oriented, then the right hand side is $\{\text{signed points in } M\}/\text{signed cobordism}$. The isomorphism in this case is given by the degree.

Example 16.0.4. We have $[S^2, S^1] \rightarrow \{\emptyset\}$. So every map $S^2 \rightarrow S^1$ is null-homotopic.

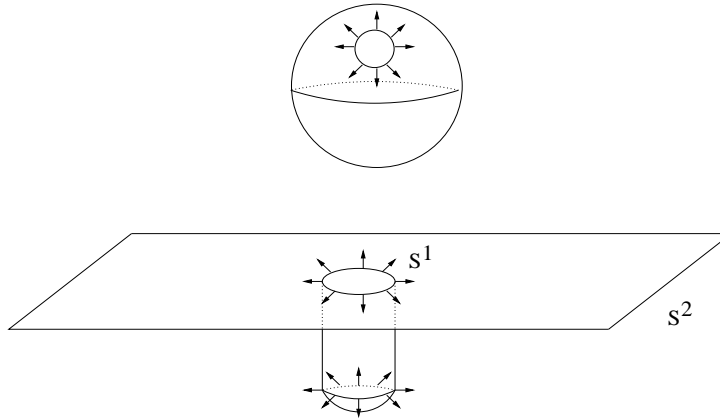

Example 16.0.5. We have $[S^3, S^2] \cong \mathbb{Z}$.

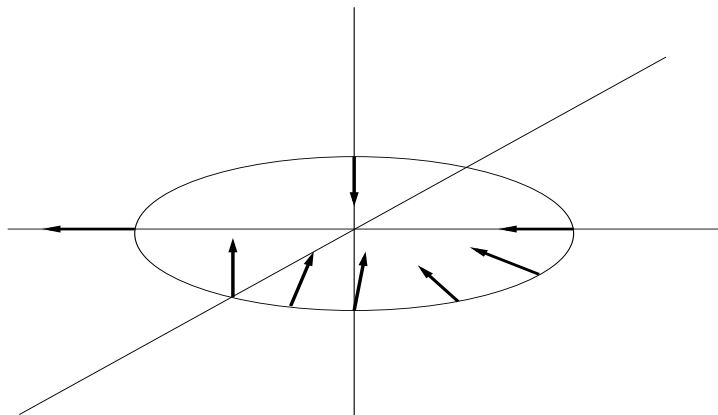

Example 16.0.6. For a genus g surface Σ_g we have $H^1(\Sigma_g; \mathbb{Z}) = \mathbb{Z}^{2g}$. As an example when $g = 2$, we have $H^1(\Sigma_2; \mathbb{Z}) = \mathbb{Z}^4$ and the geometric generators are drawn below

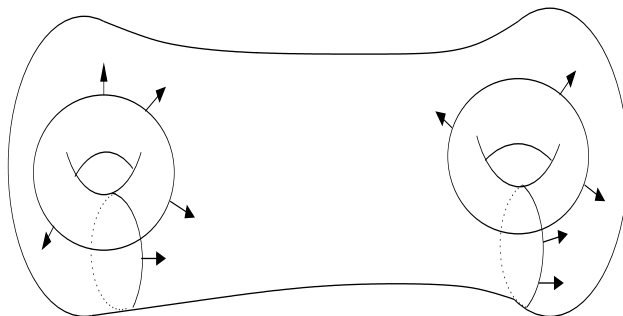

When $p = 1$, $[M, S^1] \cong H^1(M; \mathbb{Z})$ is always an abelian group. The sum of two framed manifolds is the union if disjoint. If they are not disjoint, then we have to do surgery.

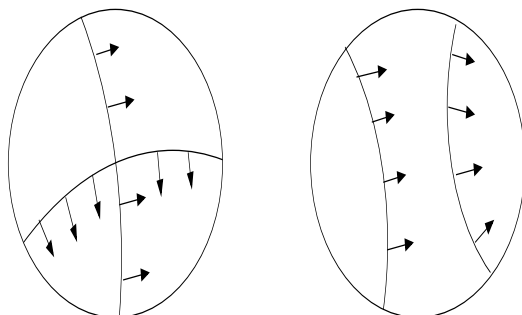

$[\Sigma_2, S^2] \cong \mathbb{Z}$ and the isomorphism is given by the degree map. The generator for $[\Sigma_2, S^2]$ is shown below.

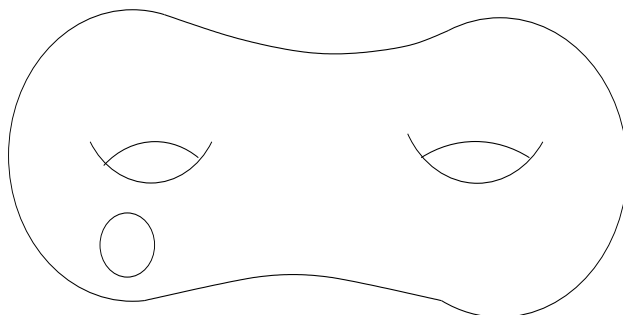

The complement of the disc is mapped to a single point on S^2 . This collapses the boundary to a point, which gives us the sphere.

Exercise

1. Show that for a map $f: S^{2n} \rightarrow S^{2n}$ there exists an $x \in S^{2n}$ such that $f(x) = x$ or $f(x) = -x$. Hence deduce that every map $f: \mathbb{R}P^{2n} \rightarrow \mathbb{R}P^{2n}$ has a fixed point. Construct a map $f: \mathbb{R}P^{2n+1} \rightarrow \mathbb{R}P^{2n+1}$ without fixed points by constructing a linear map $\mathbb{R}^{2n} \rightarrow \mathbb{R}^{2n}$ without eigenvectors.

17 Surgery

We shall motivate the study of surgery with the following example:

Example 17.0.7. Consider the following curve on the torus

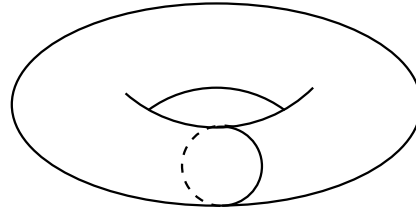

What we would like to do is to kill this element of π_1 . The annular neighbourhood of this curve gives us an embedding of $S^1 \times D^1$ into T^2 . If we remove the interior of this annular neighbourhood we obtain a cylinder with boundary $S^1 \times S^0$. Notice that $\partial S^1 \times D^2 = S^1 \times \partial D^2 = S^0 \times S^1$. Now we glue in $D^2 \times S^0$ along the corresponding boundary.

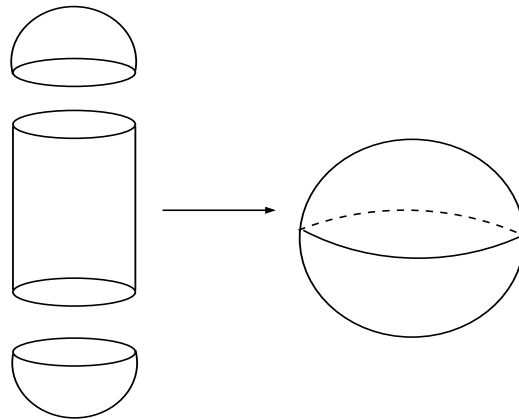

Thus we obtain a sphere. So we killed the homotopy class of the loop.

Definition 17.0.8. Given a differentiable manifold W of dimension $n = p + q + 1$ and a smooth, orientation preserving embedding

$$f: S^p \times D^{q+1} \rightarrow W,$$

let $\chi(W, f)$ denote the quotient manifold obtained from the disjoint sum

$$(W - f(S^p \times 0) + D^{p+1} \times S^q)$$

by identifying $f(u, \theta v)$ with $(\theta u, v)$ for each $u \in S^p, v \in S^q, 0 < \theta \leq 1$. Thus $\chi(W, f)$ is an orientable smooth manifold. If W' denotes any manifold which is diffeomorphic to $\chi(W, f)$, under an orientation preserving diffeomorphism, then we say that W' is obtained from W by surgery of type $(p + 1, q + 1)$.

Given a sequence W_1, \dots, W_r of manifolds such that each W_{i+1} can be obtained from W_i by a surgery we shall say that W_1 is χ -equivalent to W_r .

Theorem 17.0.4. *Two manifolds are χ -equivalent if, and only if, they lie in the same cobordism class.*

Corollary 17.0.1. *The Stiefel–Whitney numbers, Pontrjagin number, and index of a compact manifold are invariant under surgery.*

Definition 17.0.9. An imbedding $f: S^p \times D^{n-p} \rightarrow W$ represents the homotopy class $\lambda \in \pi_p(W, w_0)$ if $\lambda = f_*(i)$, where i is the generator for the infinite cyclic group $\pi_p(S^p \times D^{n-p}, x_0)$.

Suppose that λ is represented by such an imbedding. Suppose further that $n \geq 2p + 2$. Let $W' = \chi(W, f)$.

Lemma 17.0.7. *Under the above conditions we have $\pi_i(W') \cong \pi_i(W)$ for $i < p$ and $\pi_p(W')$ is isomorphic to $\pi_p(W)$ modulo a subgroup which contains λ .*

The natural question that remains is: When is a homotopy class λ represented by an imbedding. Let $g: S^p \rightarrow W$ be a map in the homotopy class of λ , and let TW denote the tangent bundle of W .

Lemma 17.0.8. *Assume that $n \geq 2p + 1$. Then there exists an imbedding $S^p \times D^{n-p} \rightarrow W$ which represents λ if, and only if, the pull-back bundle $g^*(TW)$ is trivial.*

Definition 17.0.10 (Dehn Surgery). Let M be a smooth 3-manifold, and let K be an embedded knot in M . The tubular neighbourhood T of K is diffeomorphic to a solid torus. We now remove the interior of T from M . The resulting manifold M' is a manifold with boundary a torus. Let ϕ be a diffeomorphism of the torus. Now glue a solid torus to the boundary of M' via ϕ . This process is called *Dehn surgery*

Example 17.0.8. Let $M = S^3$, and let K be the trivial knot in S^3 . Then Dehn surgery produces the 3-manifold $S^1 \times S^2$.

Theorem 17.0.5. *Every closed 3-manifold can be obtained from S^3 by Dehn surgery around finitely many knots.*

18 Integration on Manifolds

18.1 Multilinear Algebra and Tensor products

Let V be a finite dimensional vector space over the reals, and let $p \geq 1$ be an integer. A p -tensor is a multilinear map $T: V^p \rightarrow \mathbb{R}$. We denote $T^p(V^*)$ to be the vector space of all p -tensors. Notice that if $p = 1$, then $T^1(V^*)$ is just the dual space.

Definition 18.1.1. Let T be a p -tensor, and let S be a q -tensor. We define a $p + q$ -tensor $T \otimes S$ by

$$T \otimes S(v_1, \dots, v_p, v_{p+1}, \dots, v_{p+q}) := T(v_1, \dots, v_p)S(v_{p+1}, \dots, v_{p+q}).$$

The tensor product has the following properties:

- (1) $(T \otimes S) \otimes R = T \otimes (S \otimes R)$,
- (2) $T \otimes (S_1 + S_2) = T \otimes S_1 + T \otimes S_2$,
- (3) $(T_1 + T_2) \otimes S = T_1 \otimes S + T_2 \otimes S$.

The first property tell us that the tensor product is associative, the second and third properties tell us the tensor product is distributive. In general $T \otimes S \neq S \otimes T$.

Theorem 18.1.1. Suppose $\{\phi_1, \dots, \phi_k\}$ is a basis of V^* . Then $B = \{\phi_{i_1} \otimes \dots \otimes \phi_{i_p} : i_1, \dots, i_p \in \{1, 2, \dots, k\}\}$ is a basis of $T^p(V^*)$. In particular, $\dim T^p(V^*) = k^p$.

Proof. Let e_1, \dots, e_k be the dual basis of V^* , i.e., $\phi_i(e_j) = \delta_{ij}$. Then $\phi_{i_1} \otimes \dots \otimes \phi_{i_p}(e_{i_1}, \dots, e_{i_p}) = 1$. The value of all other elements of B on $(e_{i_1}, \dots, e_{i_p})$ zero. Therefore the elements in B are linearly independent. Let $T \in T^p(V^*)$, and let $S \in T^p(V^*)$ be the tensor

$$S = \sum_{(i_1, \dots, i_p)} T(e_{i_1}, \dots, e_{i_p}) \phi_{i_1} \otimes \dots \otimes \phi_{i_p}.$$

Now $S(e_{i_1}, \dots, e_{i_p}) = T(e_{i_1}, \dots, e_{i_p})$, hence they must be equal. Therefore elements in B span $T^p(V^*)$. \square

Definition 18.1.2. A p -tensor T is said to be *alternating* if

$$T(v_1, \dots, v_i, \dots, v_j, \dots, v_p) = -T(v_1, \dots, v_j, \dots, v_i, \dots, v_p).$$

Definition 18.1.3. If $\pi \in S_p$ then we define $T^\pi \in T^p(V^*)$ to be

$$T^\pi(v_1, v_2, \dots, v_p) := T(v_{\pi(1)}, v_{\pi(2)}, \dots, v_{\pi(p)}).$$

Then T is alternating if, and only if, $T^\pi = (-1)^\pi T$. We denote the space of all alternating p -tensors by $\bigwedge^p(V^*) \subseteq T^p(V^*)$.

Definition 18.1.4. For $T \in T^p(V^*)$ define $\text{Alt}(T) \in \bigwedge^p(V^*)$ by

$$\text{Alt}(T)(v_1, v_2, \dots, v_p) := \frac{1}{p!} \sum_{\pi \in S_p} (-1)^\pi T^\pi(v_1, v_2, \dots, v_p).$$

Example 18.1.1. The dot product in \mathbb{R}^n is a example of an non-alternating 2-tensor.

Example 18.1.2. If T is symmetric, then

$$\text{Alt}(T)(v_1, v_2) = \frac{1}{2}(T(v_1, v_2) - T(v_2, v_1)) = 0.$$

Definition 18.1.5. Let $T \in T^p(V^*)$ and $S \in T^q(V^*)$. The *wedge product* $T \wedge S$ is defined to be $\text{Alt}(T \otimes S)$.

Lemma 18.1.1. If $\text{Alt}(T) = 0$, then $T \wedge S = -S \wedge T = 0$.

Theorem 18.1.2. The wedge product is associative, that is, $(T \wedge S) \wedge R = T \wedge (S \wedge R)$.

Proof. The idea is to show that both sides of the equation are equal to $\text{Alt}(T \otimes S \otimes R)$. Consider $(T \wedge S) \wedge R - \text{Alt}(T \otimes S \otimes R)$. This by definition is equal to $\text{Alt}((T \wedge S) \otimes R) - \text{Alt}(T \otimes S \otimes R)$, which is equal to $\text{Alt}((T \wedge S - T \otimes S) \otimes R)$. This is then 0 by the previous lemma. \square

Example 18.1.3. Let ϕ and ψ be in $\Lambda^1(V^*) = V^*$. Then,

$$\phi \wedge \psi = \frac{1}{2}(\phi \otimes \psi - \psi \otimes \phi).$$

Therefore $\phi \wedge \phi = 0$ and $\psi \wedge \phi = -\phi \wedge \psi$.

Theorem 18.1.3. If $\{\phi_1, \dots, \phi_k\}$ is a basis of V^* , then $\{\phi_{i_1} \wedge \phi_{i_2} \wedge \dots \wedge \phi_{i_p} : 1 \leq i_1 < i_2 < \dots < i_p \leq k\}$ is a basis of $\Lambda^p(V^*)$. In particular, the dimension of $\Lambda^p(V^*)$ is $\binom{k}{p}$. Hence, $\Lambda^p(V^*) = 0$ if $p > \dim V$ and $\dim \Lambda^p(V^*) = 1$ if $k = \dim V$.

Proof. First show it is a spanning set. Let $T \in \Lambda^p(V^*) \subseteq T^p(V^*)$, then

$$T = \sum_{I=(i_1, \dots, i_p)} a_I \phi_{i_1} \otimes \phi_{i_2} \otimes \cdots \otimes \phi_{i_p}.$$

Since T is alternating we get

$$\begin{aligned} T &= \sum a_I \text{Alt}(\phi_{i_1} \otimes \phi_{i_2} \otimes \cdots \otimes \phi_{i_p}) \\ &= \sum a_I \phi_{i_1} \wedge \phi_{i_2} \wedge \cdots \wedge \phi_{i_p}. \end{aligned}$$

Now to check to linear independence. We have $\phi_{i_1} \wedge \cdots \wedge \phi_{i_p}(e_{i_1}, \dots, e_{i_p}) = 1/p!$. The value of all other elements on $(e_{i_1}, \dots, e_{i_p})$ is zero. \square

The space $T^0(V^*) = \mathbb{R}$ is just the set of constant functions on \mathbb{R} . The space $T^*(V^*) = \bigoplus_{p \geq 0} T^p(V^*)$ is an algebra with a unit under the operation \otimes and $1 \in T^0(V^*)$ is the unit. Also, $T^0(V^*) = \Lambda^0(V^*) = \mathbb{R}$.

Example 18.1.4. Let V be a three dimensional vector space over \mathbb{R} , and let ϕ_1, ϕ_2 and ϕ_3 be a basis for the dual space. Then $\Lambda^2(V^*)$ is generated by $\phi_1 \wedge \phi_2, \phi_1 \wedge \phi_3$ and $\phi_2 \wedge \phi_3$.

Corollary 18.1.1. If $T \in \Lambda^p(V^*)$ and $S \in \Lambda^q(V^*)$, then $T \wedge S = (-1)^{pq} S \wedge T$.

Proof. It suffices to prove this when T and S are basis elements. But for wedge products of 1-tensors we already know this. \square

The Exterior Algebra

$$\Lambda(V^*) := \bigoplus_{p=0}^{\dim V} \Lambda^p(V^*)$$

is an graded commutative algebra under the wedge product operation.

Let A be a linear map between vector spaces V and W . Then there is an induced map between the dual spaces. The map $A^*: W^* \rightarrow V^*$ is defined to be $A^*(\phi)(v) := \phi(Av)$. We also have a map between the space of all p -tensors. The map $A^*: T^p(W^*) \rightarrow T^p(V^*)$ is defined to be $A^*T(v_1, v_2, \dots, v_p) := T(Av_1, \dots, Av_p)$. This map commutes with the tensor product and also with Alt .

$$\begin{aligned}
A^*(T \otimes S) &= A^*T \otimes A^*S \\
Alt(A^*T) &= A^*(AltT) \\
A^*(T \wedge S) &= A^*(T) \wedge A^*(S)
\end{aligned}$$

The map A^* is an algebra homomorphism $\wedge(W^*) \rightarrow \wedge(V^*)$. It is contravariant, i.e., $(BA)^* = A^*B^*$.

Theorem 18.1.4 (Determinant Theorem). *Let V be a k -dimensional vector space over \mathbb{R} and $A: V \rightarrow V$ a linear map. Then $A^*: \wedge^k(V^*) \rightarrow \wedge^k(V^*)$ is just multiplication by $\det A$.*

Proof. Choose a basis of V , i.e., identify V with \mathbb{R}^k . Then

$$\begin{aligned}
A^*(\det)(e_1, \dots, e_k) &= \det(Ae_1, \dots, Ae_k) \\
&= \det A \\
&= \det A \det(e_1, \dots, e_k).
\end{aligned}$$

Hence $A^*(\det) = \det A \det$. □

18.2 Forms

Definition 18.2.1. A p -form on a manifold X is a function ω that assigns to each point $x \in X$ an alternating p -tensor.

We have the following pointwise operations on forms: addition, scalar product, product with functions and the wedge product.

Example 18.2.1. A 0-form on a manifold is smooth map $f: M \rightarrow \mathbb{R}$.

Example 18.2.2. If $f: X \rightarrow \mathbb{R}$ is a smooth function, then the map $df: X \rightarrow T^*X$ given by $df(x)(v) = df_x(v)$ is a 1-form since $df(x) \in \Lambda^1(T_x X)^*$.

Let $x_i: \mathbb{R}^n \rightarrow \mathbb{R}$ be the projection to the i -th coordinate. Then dx_i is a one form on \mathbb{R}^n . Moreover, $dx_i(x)(\zeta_1, \dots, \zeta_n) = \zeta_i$.

Lemma 18.2.1. *The 1-forms dx_1, \dots, dx_n make up a basis of $\Lambda^1((\mathbb{R}^n)^*)$ at every point.*

Proposition 18.2.1. *If ω is any p -form on any set $U \subseteq \mathbb{R}^n$, then*

$$\omega(x) = \sum_I a_I(x) dx_I,$$

where I ranges over all multi index $i_1 < i_2 < \dots < i_p$, $dx_I = dx_{i_1} \wedge dx_{i_2} \wedge \dots \wedge dx_{i_p}$ and $a_I: U \rightarrow \mathbb{R}$ are functions.

Definition 18.2.2. We say ω is a differentiable p -form if each a_I is a smooth function.

Example 18.2.3. Let $\phi: U \rightarrow \mathbb{R}$ be a smooth map. Then $d\phi = \sum_{i=1}^n \frac{\partial \phi}{\partial x_i} dx_i$ is differentiable.

Operations:

(1) Vector space operations: If ω and η are both p -forms, then $\omega + \eta$ is also a p -form. If $f: U \rightarrow \mathbb{R}$ is a smooth map, then $f\omega$ is also a p -form.

(2) If ω is a p -form and η is a q -form, then $\omega \wedge \eta$ is a $p + q$ -form.

Example 18.2.4. Let $\omega = f dx + g dy$ and $\eta = h dx + k dy$ both be one forms in the plane. Then

$$\begin{aligned} \omega \wedge \eta &= (f dx + g dy) \wedge (h dx + k dy) \\ &= f h dx \wedge dx + f k dx \wedge dy + g h dy \wedge dx + g k dy \wedge dy \\ &= (f k - g h) dx \wedge dy. \end{aligned}$$

(3). Let $g: M \rightarrow N$ be smooth map, and let ω be a p -form on N . The idea is to pull-back ω to get a p -form on M . Define $g^*\omega$ by

$$g^*\omega(x)(v_1, \dots, v_p) = \omega(g(x))(dg_x(v_1), \dots, dg_x(v_p)).$$

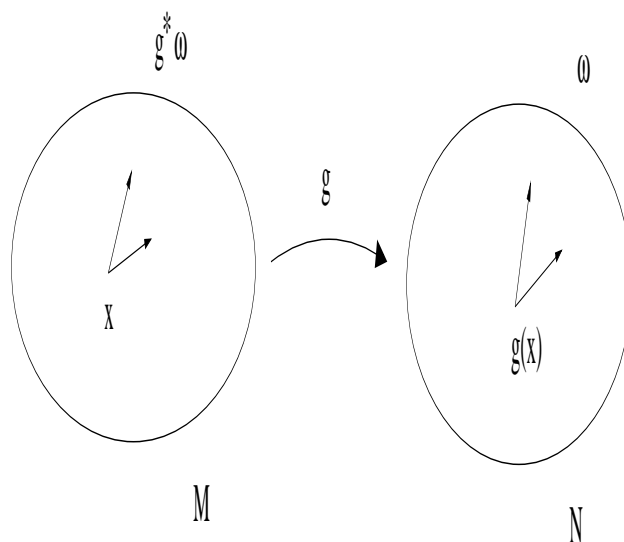

Calculations:

(1). Let $\phi: \mathbb{R}^k \rightarrow \mathbb{R}$ be a smooth map, then $d\phi$ is a one form on \mathbb{R}^k and

$$d\phi = \sum_{i=1}^k \frac{\partial \phi}{\partial x_i} dx_i.$$

(2) Let $g: \mathbb{R}^k \rightarrow \mathbb{R}^l$ be a smooth map and dx_i a one form on \mathbb{R}^l . Now

$$dx_i(dg(e_j)) = \frac{\partial g_i}{\partial x_j}.$$

Hence

$$g^*(dx_i) = \sum_{j=1}^k \frac{\partial g_i}{\partial x_j} dx_j = dg_i.$$

(3) Let $g: M \rightarrow N$ and $\omega = f: N \rightarrow \mathbb{R}$ both be smooth functions. Then $g^*\omega(x) = f(g(x))$, hence $g^*(f) = f \circ g$.

The pull-back commutes with the operations $+$ and \wedge with $g^*(\omega \wedge \eta) = g^*(\omega) \wedge g^*(\eta)$.

(4) Let $\omega = dx_1 \wedge dx_2 \wedge \cdots \wedge dx_k$ be the volume form on \mathbb{R}^k , and let $g: \mathbb{R}^k \rightarrow \mathbb{R}^k$ be smooth. Then

$$g^*(\omega) = (g^*(dx_1) \wedge \cdots \wedge g^*(dx_k)) = dg_1 \wedge \cdots \wedge dg_k.$$

The determinant theorem implies

$$g^*(dx_1 \wedge dx_2 \wedge \cdots \wedge dx_k) = \det(dg)(dx_1 \wedge \cdots \wedge dx_k).$$

Lemma 18.2.2. *Suppose ω is a differentiable p -form on $U \subseteq \mathbb{R}^k$ and $g: V \rightarrow U$ is smooth, then $g^*(\omega)$ is a differentiable p -form.*

Definition 18.2.3. Let ω be a p -form on M . We say ω is differentiable if for every chart $\varphi: U \rightarrow V$, the form $(\varphi^{-1})^*(\omega|_U)$ is a differentiable p -form on V .

The pull-back is contravariant, meaning $(g \circ f)^* = f^* \circ g^*$. The vector space of all differentiable p -forms on a manifold M is denoted by $\Omega^p(M)$.

18.3 Integration

Definition 18.3.1. Let ω be a differentiable k -form on $U \subset \mathbb{R}^k$ (open). Then $\omega = a dx_1 \wedge \cdots \wedge dx_k$, where $a: U \rightarrow \mathbb{R}$ is smooth. If a is integrable in the sense of Riemann, then we define the integral of ω over U to be

$$\int_U \omega := \int_U a dx_1 \dots dx_k.$$

Proposition 18.3.1 (Change of Variables). Let $f: V \rightarrow U$ be an orientation preserving diffeomorphism between open sets in \mathbb{R}^k . Then,

$$\int_U \omega = \int_V f^*(\omega),$$

for any k -form on U .

Proof. Let $\omega = a dx_1 \wedge dx_2 \wedge \cdots \wedge dx_k$, then

$$\begin{aligned} f^*(\omega) &= f^*(a) f^*(dx_1 \wedge dx_2 \wedge \cdots \wedge dx_k) \\ &= (a \circ f)(\det df) dx_1 \wedge dx_2 \wedge \cdots \wedge dx_k. \end{aligned}$$

Hence

$$\int_U a dx_1 \dots dx_k = \int_V (a \circ f)(\det df) dx_1 \dots dx_k.$$

Now calculus says: If $f: V \rightarrow U$ is a diffeomorphism, then

$$\int_U a dx_1 \dots dx_k = \int_V (a \circ f) |\det df| dx_1 \dots dx_k.$$

Hence if f is orientation preserving we have the result and if f is orientation reversing, then

$$\int_U \omega = - \int_V f^*(\omega).$$

□

Definition 18.3.2. Let M^k be an oriented manifold, and let ω be a k -form on M . We define the *support* to be

$$\text{supp}(\omega) := \overline{\{x \in M : \omega(x) \neq 0\}}.$$

If the support of ω is contained in a single oriented chart, say $\phi: U \rightarrow \phi(U) \subseteq \mathbb{R}^k$, then we define the integral of ω to be

$$\int_M \omega = \int_U \omega := \int_{\phi(U)} (\phi^{-1})^*(\omega).$$

Proposition 18.3.2. *The definition above does not depend on the choice of oriented chart.*

Proof. Let (V, ψ) be another oriented chart so that the support of ω is contained in V . Notice then that the support is contained in $U \cap V$. The map $\psi \circ \phi^{-1}: \phi(U \cap V) \rightarrow \psi(U \cap V)$ is an orientation preserving diffeomorphism. Therefore

$$\begin{aligned} \int_{\psi(V)} (\psi^{-1})^*(\omega) &= \int_{\psi(U \cap V)} (\psi^{-1})^*(\omega) \\ &= \int_{\phi(U \cap V)} (\psi \circ \phi^{-1})^*(\psi^{-1})^*(\omega) \\ &= \int_{\phi(U \cap V)} (\phi^{-1})^*(\omega) \\ &= \int_{\phi(U)} (\phi^{-1})^*(\omega). \end{aligned}$$

□

If ω has compact support, let $\{(U_i, \phi_i)\}$ be a finite cover of the support of ω , and let ρ_i be a smooth partition of unity on M such that $\text{supp}(\rho_i)$ is contained in a single chart. Write $\omega = \sum_i \rho_i \omega$. We then define the integral of ω to be

$$\int_M \omega := \sum_j \int_M \rho_j \omega.$$

Proposition 18.3.3. *The definition above is well-defined.*

Proof. Let $\{\tilde{U}_j, \tilde{\phi}_j\}$ be another finite cover of the support of ω , and $\tilde{\rho}_j$ be a partition of unity subordinate to this open cover. Then for each i we have

$$\begin{aligned} \int_M \rho_i \omega &= \int_M \left(\sum_j \tilde{\rho}_j \right) \rho_i \omega \\ &= \sum_j \int_M \tilde{\rho}_j \rho_i \omega. \end{aligned}$$

Now summing over i we have

$$\sum_i \int_M \rho_i \omega = \sum_{i,j} \int_M \tilde{\rho}_j \rho_i \omega.$$

Notice that each term in the last sum is the integral of a compactly supported form which is contained in a single chart. So by the previous proposition each term is well-defined, that is, it does not matter which chart we use to compute it. The same argument starting with

$$\int_M \tilde{\rho}_j \omega,$$

shows that

$$\sum_j \int_M \tilde{\rho}_j \omega = \sum_{i,j} \int \tilde{\rho}_j \rho_i \omega.$$

□

Example 18.3.1. Let M be a zero dimensional manifold, for example \mathbb{Z} . Then ω is a compactly supported 0-form if ω assigns a number for each point with only finitely many nonzero. For example, let ω be the form in the figure below



Then $\int \omega = 3 - 2 + 1 = 2$.

Example 18.3.2. Let $M = \mathbb{R}$, and let $\omega = f(t)dt$, where $f: \mathbb{R} \rightarrow \mathbb{R}$ is a compactly supported smooth function. Then $\int_M \omega = \int_{-\infty}^{\infty} f(t)dt$.

18.4 Exterior derivative

We want a map $d: \Omega^p M \rightarrow \Omega^{p+1} M$ with the following properties:

- (1) d is linear,
- (2) Satisfies the Leibniz rule: $d(\omega \wedge \eta) = d\omega \wedge \eta + (-1)^p \omega \wedge d\eta$,
- (3) Has the cocycle condition, $d \circ d = 0$,
- (4) Agrees with the standard d on 0-forms.

Theorem 18.4.1. *There is a unique operator that satisfies the four conditions.*

Proof. We shall prove this when M is an open subset in \mathbb{R}^k . Let $\omega = \sum_I a_I dx_I$. Then,

$$\begin{aligned} d\omega &= \sum d(a_I dx_I) \quad (\text{by Linearity}) \\ &= \sum_I da_I \wedge dx_I + a_I d(dx_I) \\ &= \sum_I da_I \wedge dx_I. \end{aligned}$$

Let us check that if we define $d\omega$ to be $\sum_I da_I \wedge dx_I$ then this does indeed satisfy the conditions we want.

Let $\omega = f dx_I$ and $\eta = g dx_J$ both be p -forms. Then, $\omega \wedge \eta = f g dx_I \wedge dx_J$ and

$$\begin{aligned} d(\omega \wedge \eta) &= d(fg) \wedge dx_I \wedge dx_J \\ &= (df \cdot g + f \cdot dg) \wedge dx_I \wedge dx_J. \end{aligned}$$

Also,

$$d\omega \wedge \eta = df \wedge dx_I \wedge (g dx_J)$$

and

$$\begin{aligned} \omega \wedge d\eta &= f dx_I \wedge (dg \wedge dx_J) \\ &= (-1)^p (fdg) \wedge dx_I \wedge dx_J. \end{aligned}$$

Let $f: U \rightarrow \mathbb{R}$ be a smooth function. Then

$$df = \sum_{i=1}^k \frac{\partial f}{\partial x_i} dx_i.$$

Hence

$$d(df) = \sum_{i=1}^k \sum_{j=1}^k \frac{\partial^2 f}{\partial x_i \partial x_j} dx_j \wedge dx_i = 0.$$

Since

$$\frac{\partial^2 f}{\partial x_i \partial x_j} dx_j \wedge dx_i = -\frac{\partial^2 f}{\partial x_j \partial x_i} dx_i \wedge dx_j.$$

Thus by property (2) $d(dw) = 0$ for all p -forms. Thus, there is a unique linear operator $d: \Omega^p(U) \rightarrow \Omega^{p+1}(U)$ that satisfies the four conditions. \square

Corollary 18.4.1. *Let $f: V \rightarrow U$ be a diffeomorphism, and let ω be a p -form on U . Then $f^*(d\omega) = d(f^*(\omega))$.*

Proof. Define an operator $D: \Omega^p(V) \longrightarrow \Omega^{p+1}(V)$ by

$$D(\eta) = (f^{-1})^*(d((f^*\eta))).$$

You can check that this function satisfies all four conditions, hence $D = d$. Therefore $f^*(d\eta) = d(f^*(\eta))$ \square

We now extend this to manifolds. Let ω be a p -form on M . Suppose that $x \in M$ is contained in a chart $\varphi: U \longrightarrow V$. Then we define $d\omega$ at x to be

$$d\omega(x) := \varphi^*d(\varphi^{-1})^*(\omega)(x).$$

Here the d on the right hand side of the equation is the exterior derivative in Euclidean space (sorry for the abuse of notation). We leave it to the reader to check that this definition is well-defined.

Theorem 18.4.2. *Let $g: M \longrightarrow N$ be a smooth map, and let ω be a p -form on N . Then $g^*(d\omega) = d(g^*\omega)$.*

18.5 Stoke's theorem

Theorem 18.5.1. *Let M be an n -dimensional manifold possibly with boundary, and let ω a compactly supported $(n-1)$ -form. Then*

$$\int_M d\omega = \int_{\partial M} \omega.$$

Proof. We shall prove this theorem for the case when $M = \mathbb{R}^n$ and $M = H^n$. Let us first do the case when $M = \mathbb{R}^n$. It suffies to prove the theorem for a compactly supported $(n-1)$ -form $\omega = f dx_1 \wedge \cdots \wedge dx_{n-1}$. Since the support of ω is compact there exists an R so that the support of ω is entirely contained in the square $[-R, R] \times \cdots \times [-R, R]$.

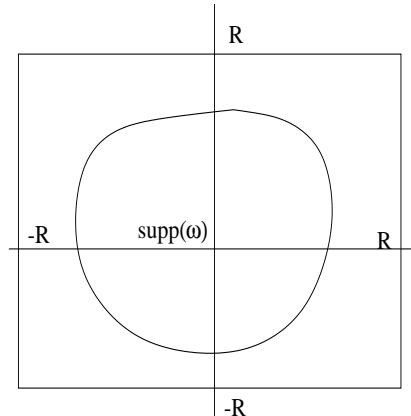

The boundary of \mathbb{R}^n is empty so we have to show that $\int_{\mathbb{R}^n} d\omega = 0$. We have

$$\begin{aligned}
 \int_{\mathbb{R}^n} d\omega &= \int_{\mathbb{R}^n} d(f dx_1 \wedge \cdots \wedge dx_{n-1}) \\
 &= \int_{\mathbb{R}^n} \frac{\partial f}{\partial x_n} dx_1 \wedge \cdots \wedge dx_n \\
 &= \int_{-R}^R \cdots \int_{-R}^R \frac{\partial f}{\partial x_n} dx_1 \cdots dx_n \\
 &= \int_{-R}^R \cdots \int_{-R}^R \frac{\partial f}{\partial x_n} dx_n dx_1 \cdots dx_{n-1} \\
 &= \int_{-R}^R \cdots \int_{-R}^R [f(0, \dots, 0, R) - f(0, \dots, 0, -R)] dx_1 \cdots dx_{n-1} \\
 &= 0.
 \end{aligned}$$

Now for the case when $M = H^n$. Let

$$\omega = \sum_{i=1}^n f_i dx_1 \wedge \cdots \wedge \tilde{dx}_i \wedge \cdots \wedge dx_n,$$

where \tilde{dx}_i means that dx_i is omitted. Now there exists an R so that the support of ω is contained in the rectangle $[-R, R] \times \cdots \times [-R, R] \times [0, R]$.

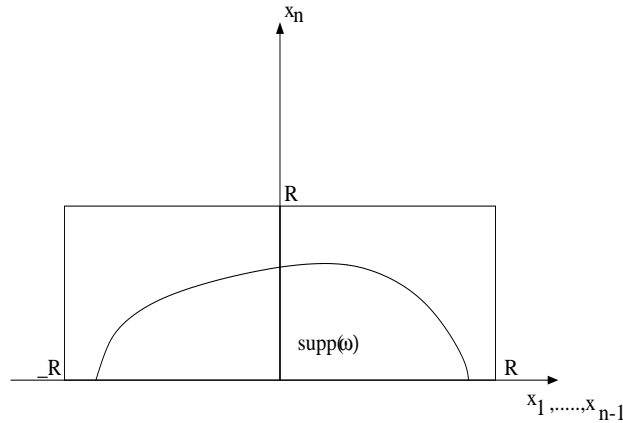

Then

$$\begin{aligned}
\int_{H^n} d\omega &= \int_{H^n} \sum_{i=1}^n d(f_i dx_1 \wedge \cdots \wedge \tilde{dx}_i \wedge \cdots \wedge dx_{n-1}) \\
&= \int_{H^n} \sum_{i=1}^n (-1)^{i-1} \frac{\partial f_i}{\partial x_i} dx_1 \wedge \cdots \wedge dx_n \\
&= \int_0^R \int_{-R}^R \cdots \int_{-R}^R \sum_{i=1}^n (-1)^{i-1} \frac{\partial f_i}{\partial x_i} dx_1 \wedge \cdots \wedge dx_n \\
&= \int_{-R}^R \cdots \int_{-R}^R \int_0^R (-1)^{n-1} \frac{\partial f_n}{\partial x_n} dx_n dx_1 \cdots dx_{n-1} \\
&= (-1)^n \int_{-R}^R \cdots \int_{-R}^R f_n(x_1, \dots, x_{n-1}, 0) dx_1 \cdots dx_{n-1}.
\end{aligned}$$

We have

$$\begin{aligned}
\int_{\partial H^n} \omega &= \int_{\partial H^n} \sum_{i=1}^n f_i dx_1 \wedge \cdots \wedge \tilde{dx}_i \wedge \cdots \wedge dx_{n-1} \\
&= \int_{\partial H^n} f_n(x_1, \dots, x_{n-1}, 0) dx_1 \cdots dx_{n-1} \\
&= (-1)^n \int_{-R}^R \cdots \int_{-R}^R f_n(x_1, \dots, x_{n-1}, 0) dx_1 \cdots dx_{n-1}.
\end{aligned}$$

The last line is due to the fact that the boundary orientation for ∂H^n is $(-1)^n$ times the orientation for \mathbb{R}^{n-1} . \square

Example 18.5.1. Let $M = [a, b] \subset \mathbb{R}$, and let ω be a zero form on M , i.e., ω is a smooth function from M to \mathbb{R} . Then Stoke's theorem in this case is just the fundamental theorem of calculus,

$$\int_a^b \omega' dt = \omega(b) - \omega(a).$$

Example 18.5.2. Let ω be the one form $f dx + g dy$. Then

$$\int_{\partial\Omega} \omega = \int_{\Omega} \left(\frac{\partial g}{\partial x} - \frac{\partial f}{\partial y} \right) dx dy.$$

This is known as Green's theorem.

Example 18.5.3. Let $\omega = xdy$ a 1-form in \mathbb{R}^2 . Then $d\omega = dx \wedge dy$, which is the area form. Hence the area of the region Ω (which is shown below) is

$$\int_{\Omega} d\omega = \int_{\partial\Omega} \omega = 8.$$

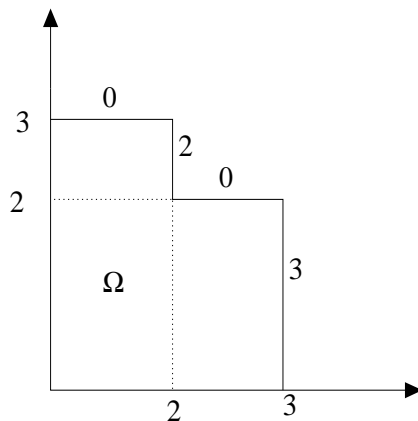

A p -form ω in M assigns a number to every oriented p -submanifold of M by integrating ω over the p -submanifold.

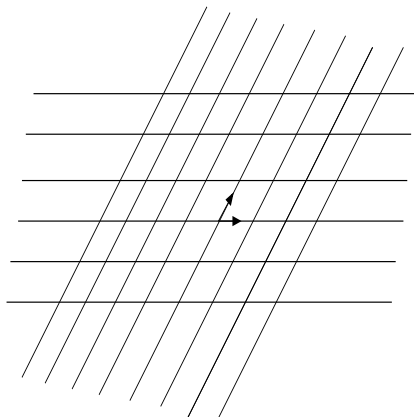

A 1-form in the plane would assign a number to each edge and a 2-form would assign a number to each face.

If ω is a p -form, then $d\omega$ is a $(p+1)$ -form. Let S be a $(p+1)$ submanifold, then by Stoke's theorem we have $\int_S d\omega = \int_{\partial} \omega$.

Exercises

1. Finish the proof of Stoke's theorem, i.e., show that the theorem is true for any manifold. (Hint: First assume that the support of ω is contained in a single chart, and prove that the theorem is true. Then use a partition of unity to show that it is true in general).

2. (a) Prove that the surface

$$S = \{(x, y, z): \frac{x^2}{4} + \frac{(x-y)^2}{12} + (y+z-x)^2 = 10\}$$

is a two-dimensional submanifold of \mathbb{R}^3 .

(b) Let ω be the 2-form on \mathbb{R}^3 given by

$$\omega = (ze^x - e^z)dx \wedge dz + (xe^y - e^x)dy \wedge dz + (ye^z - e^y)dz \wedge dx.$$

Let S be the surface in part (a). Compute $\int_S \omega$.

19 de Rham Cohomology

Let M be a manifold. We then have the following chain complex:

$$0 \rightarrow \Omega^0(M) \xrightarrow{d} \Omega^1(M) \xrightarrow{d} \dots \xrightarrow{d} \Omega^n(M) \rightarrow 0$$

This chain complex is called the *de Rham complex*, which we denote $\Omega^*(M)$.

Definition 19.0.1. The p -th de Rham cohomology group (vector space) is

$$H_{Dr}^p(M) = \ker[d: \Omega^p(M) \rightarrow \Omega^{p+1}(M)] / \text{Im}[d: \Omega^{p-1}(M) \rightarrow \Omega^p(M)]$$

Definition 19.0.2. We say ω is closed if $d\omega = 0$, and ω is exact if there exists η such that $\omega = d\eta$.

Example 19.0.4. Let $M = \mathbb{R}^2 - \{(0, 0)\}$ and

$$\omega = \frac{-x_2}{x_1^2 + x_2^2} dx_1 + \frac{x_1}{x_1^2 + x_2^2} dx_2.$$

It is easy to verify that ω is closed. Does there exist a function $F: M \rightarrow \mathbb{R}$ such that $dF = \omega$? Suppose that F exists, then

$$\frac{\partial F}{\partial x_1} = \frac{-x_2}{x_1^2 + x_2^2} \quad \text{and} \quad \frac{\partial F}{\partial x_2} = \frac{x_1}{x_1^2 + x_2^2}.$$

The first fundamental theorem of calculus tells us that

$$\int_0^{2\pi} \frac{d}{d\theta} F(\cos \theta, \sin \theta) d\theta = F(1, 0) - F(1, 0) = 0.$$

On the other hand the chain rule gives

$$\frac{d}{d\theta} F(\cos \theta, \sin \theta) = \frac{\partial F}{\partial x_1}(-\sin \theta) + \frac{\partial F}{\partial x_2} \cos \theta = 1,$$

which is a contradiction. Hence no such F exists. Therefore ω is not exact.

The last example illustrates the fact that de Rham cohomology detects when there are "holes" in our manifold.

Lemma 19.0.1. *The vector space $H^0(M) := \{\text{closed } 0\text{-forms}\}$ is isomorphic to \mathbb{R}^c , where c is the number of components of M .*

Remark: The functor $H_{D^r}^p$ is a contravariant functor from the category of smooth manifolds and smooth maps to the category of vector spaces and linear maps.

Proposition 19.0.1. *The induced map $f^*: \Omega^p(Y) \longrightarrow \Omega^p(X)$ sends closed forms to closed forms, likewise, sends exact forms to exact forms.*

Proof. Let ω be a closed form on Y . Then $d(f^*\omega) = f^*(d\omega) = f^*0 = 0$. Now suppose that ω is exact. Then $f^*(\omega) = f^*(d\eta) = d(f^*\eta)$. Hence $f^*\omega$ is exact. \square

Lemma 19.0.2 (Poincaré Lemma). *Let X be a manifold, and let $\pi: X \times \mathbb{R} \longrightarrow X$ be the projection map. Let $t \in \mathbb{R}$. Then $\pi^* \circ i_t^* = 1$, where $i_t: X \longrightarrow X \times \mathbb{R}$ is defined by $i_t(x) = (x, t)$.*

Proof. We shall prove the Poincaré lemma for when $X = U$, an open subset of \mathbb{R}^k .

Let ω be a p -form in $U \times \mathbb{R}$, then

$$\omega(x, t) = \sum_I f_I(x, t) dx_I \wedge dt + \sum_J g_J(x, t) dx_J$$

Now define a $(p-1)$ -form by

$$P\omega(x, t) = \sum_I \left[\int_0^t f_I(x, s) ds \right] dx_I.$$

We claim that

$$dP\omega + P d\omega = \omega - \pi^* i_0^* \omega.$$

The p -form ω is closed so $P(d\omega) = 0$. Hence we are done if we can prove the claim.

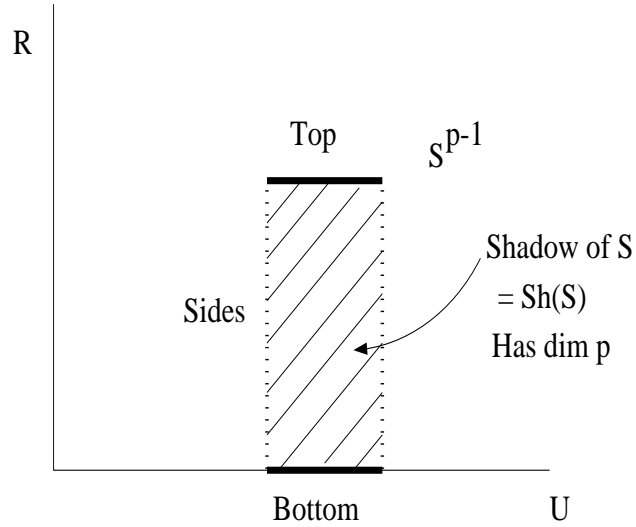

We have

$$\begin{aligned} \int_S P(d\omega) &= \int_{SH(S)} d\omega \\ &= \int_S \omega - \int_S \pi^* i_0^* \omega - \int_{SH(\partial S)} \omega \end{aligned}$$

Also,

$$\begin{aligned} \int_{SH(\partial S)} \omega &= \int_{\partial S} P\omega \\ &= \int_S dP\omega \end{aligned}$$

Therefore our claim is true. □

The next few results are immediate consequences of the Poincaré Lemma.

Theorem 19.0.2. *The de Rham cohomology of \mathbb{R} is given by*

$$H_{Dr}^p(\mathbb{R}) = \begin{cases} \mathbb{R} & \text{if } p = 0, \\ 0 & \text{otherwise.} \end{cases}$$

Proof. For $p = 0$ and $p > 1$ we know this is true. Let $p = 1$. We have to show that every 1-form is exact. Let $\omega = f(x)dx$. Define $g: \mathbb{R} \rightarrow \mathbb{R}$ by

$$g(x) = \int_0^x f(t)dt.$$

It is then clear that $g'(x) = f(x)$. Hence ω is exact. □

Theorem 19.0.3. *The de Rham cohomology of \mathbb{R}^n is given by*

$$H_{Dr}^p(\mathbb{R}^n) = \begin{cases} \mathbb{R} & \text{if } p = 0, \\ 0 & \text{otherwise.} \end{cases}$$

Proof. Proceed by induction on n . □

Proposition 19.0.2. *The functor H_{Dr}^p is a homotopy functor: If $f, g: X \rightarrow Y$ are homotopic, then $f^* = g^*: H_{Dr}^p(Y) \rightarrow H_{Dr}^p(X)$.*

Proof. Since $f \simeq g$ there exists $H: X \times \mathbb{R} \rightarrow Y$, with $f = H \circ i_0$ and $g = H \circ i_1$. Hence $f^* = i_0^* H^*$, but by Poincaré $i_0^* = i_1^*$. So $f^* = i_1^* H^* = g^*$. □

Proposition 19.0.3. *If $f: X \rightarrow Y$ is a homotopy equivalence, then*

$$f^*: H_{Dr}^p(Y) \rightarrow H_{Dr}^p(X)$$

is an isomorphism.

Proof. Let $g: Y \rightarrow X$ be a homotopy inverse, i.e., $gf \simeq 1$ and $fg \simeq 1$. Hence $f^*g^* = 1$ and $g^*f^* = 1$, which implies f^* is an isomorphism. □

Notice this gives us an alternative way of computing de Rham cohomology of \mathbb{R}^n , since \mathbb{R}^n is homotopy equivalent to a point. Since $H_{Dr}^p(\mathbb{R}^3) = 0$ for $p \neq 0$, we recover standard calculus theorems

$$0 \rightarrow \Omega^0(\mathbb{R}^3) \rightarrow \Omega^1(\mathbb{R}^3) \rightarrow \Omega^2(\mathbb{R}^3) \rightarrow \Omega^3(\mathbb{R}^3) \rightarrow 0$$

$$\text{Functions} \xrightarrow{\text{Gradient}} \text{Vector fields} \xrightarrow{\text{Curl}} \text{Vector fields} \xrightarrow{\text{Divergence}} \text{Functions}$$

Suppose ω is a closed p -form on a manifold M , and N is an oriented p -dimensional submanifold such that

$$\int_N \omega \neq 0.$$

Then ω is not exact, for if $\omega = d\eta$, then

$$\int_N \omega = \int_N d\eta = \int_{\partial N} \eta = 0.$$

From now on we shall use the notation $H^p(M)$ instead of $H_{Dr}^p(M)$ to denote the p -th de Rham cohomology group.

Definition 19.0.3. Let M be a n -manifold, then we can define a bilinear, associative and graded-commutative product

$$H^p(M) \times H^q(M) \longrightarrow H^{p+q}(M)$$

by setting $[\omega_1][\omega_2] = [\omega_1 \wedge \omega_2]$. This operation is well-defined since

$$\begin{aligned} (\omega_1 + d\eta_1) \wedge (\omega_2 + d\eta_2) &= \omega_1 \wedge \omega_2 + d\eta_1 \wedge \omega_2 + \omega_1 \wedge d\eta_2 + d\eta_1 \wedge d\eta_2 \\ &= \omega_1 \wedge \omega_2 + d(\eta_1 \wedge \omega_2 + (-1)^p \omega_1 \wedge \eta_2 + \eta_1 \wedge d\eta_2). \end{aligned}$$

This gives us a graded algebra

$$H^*(M) = \bigoplus_{p=0}^n H^p(M),$$

where the multiplication is the operation defined above, we call this algebra the *cohomology algebra*.

Exercises

1. Find the de Rham cohomology of the Möbius band.
2. Show that if γ_0 and γ_1 are homotopic curves and ω is a 1-form, then

$$\int_{\gamma_0} \omega = \int_{\gamma_1} \omega.$$

3. Let ω be a 1-form on a manifold M . Suppose that

$$\int_C \omega = 0$$

for every closed curve C . Show that ω is exact.

4. Show that if a manifold M is simply connected, then $H^1(M) = 0$.

19.1 Mayer-Vietoris Sequence

Definition 19.1.1. A sequence of vector spaces and linear maps

$$\rightarrow V_1 \xrightarrow{f_1} V_2 \xrightarrow{f_2} V_3 \rightarrow$$

is *exact* if $\ker f_{i+1} = \text{Im } f_i$.

Let X be a manifold, and let $X = U \cup V$, with U and V open.

Lemma 19.1.1. *The following sequence is exact*

$$0 \rightarrow \Omega^p(X) \xrightarrow{\alpha} \Omega^p(U) \oplus \Omega^p(V) \xrightarrow{\beta} \Omega^p(U \cap V) \rightarrow 0,$$

where $\alpha(\omega) = (\omega|_U, \omega|_V)$ and $\beta(\omega_1, \omega_2) = \omega_1|_{U \cap V} - \omega_2|_{U \cap V}$.

Proof. We shall only prove β is surjective: this is the only nontrivial part of the proof. Let $\eta \in \Omega^p(U \cup V)$, and let $\{U, V\}$ be an open cover of X . Now let $\{f, 1 - f\}$ be a partition of unity subordinate to this open cover. The form $f\eta$ extends by zero to a form on V and $(1 - f)\eta$ extends by zero to a form on U . \square

Homological algebra

A short exact sequence of chain complexes induces a long exact sequence in cohomology.

$$\begin{array}{ccccccc} & & 0 & & 0 & & \\ & & \downarrow & & \downarrow & & \\ 0 & \longrightarrow & \Omega^0(X) & \longrightarrow & \Omega^1(X) & \longrightarrow & \dots \\ & & \downarrow & & \downarrow & & \\ 0 & \longrightarrow & \Omega^0(U) \oplus \Omega^0(V) & \longrightarrow & \Omega^1(U) \oplus \Omega^1(V) & \longrightarrow & \dots \\ & & \downarrow & & \downarrow & & \\ 0 & \longrightarrow & \Omega^0(U \cap V) & \longrightarrow & \Omega^1(U \cap V) & \longrightarrow & \dots \\ & & \downarrow & & \downarrow & & \\ & & 0 & & 0 & & \end{array}$$

$$\begin{aligned} 0 \rightarrow H^0(X) &\xrightarrow{\alpha_*} H^0(U) \oplus H^0(V) \xrightarrow{\beta_*} H^0(U \cap V) \rightarrow \\ H^1(X) &\rightarrow H^1(U) \oplus H^1(V) \rightarrow H^1(U \cap V) \rightarrow H^2(X) \rightarrow \dots \end{aligned}$$

This long exact sequence is called the Mayer-Vietoris sequence.

Example 19.1.1. Let $X = S^1$. We can cover S^1 with $U = S^1 - (0, 1)$ and $V = S^1 - (0, -1)$. Now both U and V are contractible, hence

$$H^i(U) = H^i(V) = \begin{cases} \mathbb{R} & \text{if } i = 0, \\ 0 & \text{otherwise.} \end{cases}$$

We know that $H^0(S^1) = \mathbb{R}$ and $H^i(S^1) = 0$ if $i > 1$. To find out $H^1(S^1)$ we use the following portion of the Mayer-Vietoris sequence:

$$H^0(U) \oplus H^0(V) \rightarrow H^0(U \cap V) \rightarrow H^1(S^1) \rightarrow H^1(U) \oplus H^1(V)$$

This gives us

$$\mathbb{R} \oplus \mathbb{R} \rightarrow \mathbb{R}^2 \rightarrow H^1(S^1) \rightarrow 0$$

The image of the map from $\mathbb{R} \oplus \mathbb{R}$ to \mathbb{R}^2 is just \mathbb{R} . Hence $H^1(S^1) \cong \mathbb{R}$.

Example 19.1.2. We can use the results we have so far to compute $H^i(S^2)$.

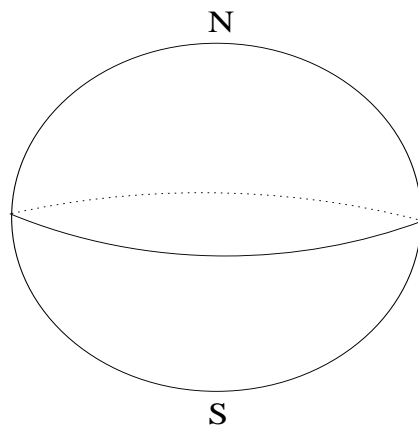

We can cover S^2 by $U = S^2 - \{N\}$ and $V = S^2 - \{S\}$. Then $U \cap V = S^2 - \{N, S\} \simeq S^1$. We now look at the exact sequence

$$H^0(U) \oplus H^0(V) \longrightarrow H^0(U \cap V) \longrightarrow H^1(S^2) \longrightarrow H^1(U) \oplus H^1(V)$$

We know that $H^1(U \cap V) \cong \mathbb{R}$ and $H^1(U) \cong H^1(V) \cong \mathbb{R}$. We then get the following exact sequence:

$$\mathbb{R} \oplus \mathbb{R} \longrightarrow \mathbb{R} \longrightarrow H^1(S^2) \longrightarrow 0$$

In order to find $H^1(S^2)$ we have to find out what the map $\mathbb{R} \oplus \mathbb{R} \longrightarrow \mathbb{R}$ is. The element $(1, 0)$ is mapped to 1. So this map is surjective. This tells us that $H^1(S^2) = 0$. Now to find $H^2(S^2)$. In order to do this we look at the following exact sequence:

$$H^1(U) \oplus H^1(V) \longrightarrow H^1(U \cap V) \longrightarrow H^2(S^2) \longrightarrow H^2(U) \oplus H^2(V)$$

Hence $H^2(S^2) = \mathbb{R}$. Therefore

$$H^i(S^2) = \begin{cases} \mathbb{R} & \text{if } i = 0, 2, \\ 0 & \text{otherwise.} \end{cases}$$

By induction we obtain

$$H^i(S^n) = \begin{cases} \mathbb{R} & \text{if } i = 0, n, \\ 0 & \text{otherwise.} \end{cases}$$

Proposition 19.1.1. *If $n \neq m$, then \mathbb{R}^n and \mathbb{R}^m are not homeomorphic.*

Proof. Let $h: \mathbb{R}^n \rightarrow \mathbb{R}^m$ be a homeomorphism we can assume that $h(0) = 0$. Therefore h induces a homeomorphism between $\mathbb{R}^n - 0$ and $\mathbb{R}^m - 0$, which implies

$$H^p(\mathbb{R}^n - 0) \cong H^p(\mathbb{R}^m - 0)$$

for all p . But $\mathbb{R} = H^{n-1}(\mathbb{R}^n - 0) \neq H^{n-1}(\mathbb{R}^m - 0) = 0$. □

Lemma 19.1.2 (Klee trick). *Let X and Y be compact subsets of \mathbb{R}^n . If X and Y are homeomorphic, then $X \times 0$ and $0 \times Y$ are isotopic.*

Proof. Let $h: X \rightarrow Y$ be a homeomorphism and let Z be the graph of h , that is, $Z = \{(x, h(x)) \in \mathbb{R}^n \times \mathbb{R}^n : x \in X\}$.

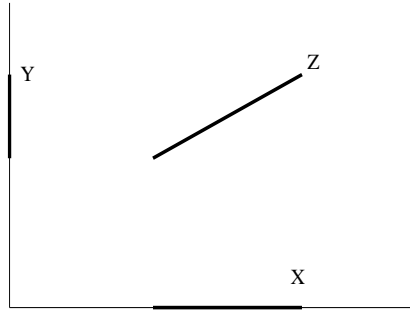

Now let $\tilde{h}: \mathbb{R}^n \rightarrow \mathbb{R}^n$ be a continuous extension, the Tietze extension theorem tells us that one exists. Define $\phi_t: \mathbb{R}^n \times \mathbb{R}^n \rightarrow \mathbb{R}^n \times \mathbb{R}^n$ by $\phi_t(x, y) = (x, y + t\tilde{h}(x))$, then this is an isotopy taking X to Z . Similarly, there exists an isotopy taking Z to Y . □

Lemma 19.1.3. *Let X be a closed subset of \mathbb{R}^n . Then we have the following isomorphisms:*

$$\begin{aligned} H^{p+1}(\mathbb{R}^{n+1} - X \times 0) &\cong H^p(\mathbb{R}^n - X) \quad \text{for } p \geq 1 \\ H^1(\mathbb{R}^{n+1} - X \times 0) &\cong H^0(\mathbb{R}^n - X)/\mathbb{R} \\ H^0(\mathbb{R}^{n+1} - X) &\cong \mathbb{R}. \end{aligned}$$

Proof. Let $A_- = \{(x, t) \in \mathbb{R}^n \times \mathbb{R} : t < d(x, X)\}$ and $A_+ = \{(x, t) \in \mathbb{R}^n \times \mathbb{R} : t > -d(x, X)\}$.

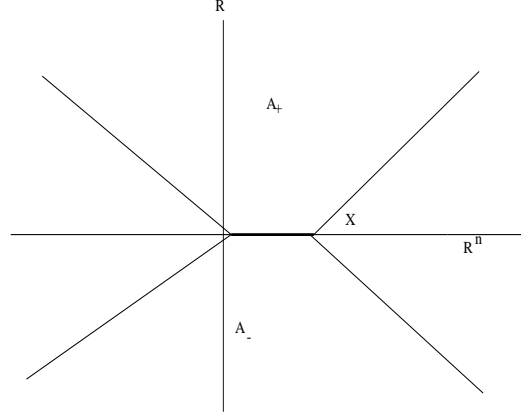

Then $A_- \cap A_+ \simeq \mathbb{R}^n - X$ and $A_- \cup A_+ = \mathbb{R}^{n+1} - X \times 0$. We now use the Mayer-vietoris sequence with these sets. Since A_- and A_+ are both contractible we obtain the first result. Consider the exact sequence

$$0 \rightarrow H^0(\mathbb{R}^{n+1} - X \times 0) \xrightarrow{i^*} H^0(A_-) \oplus H^0(A_+) \xrightarrow{j^*} H^0(\mathbb{R}^n - X) \xrightarrow{\partial^*} H^1(\mathbb{R}^{n+1} - X \times 0) \rightarrow 0$$

Now the image of j^* is isomorphic to \mathbb{R} . Therefore

$$H^1(\mathbb{R}^{n+1} - X \times 0) \cong H^0(\mathbb{R}^n - X)/\mathbb{R}$$

Also, the kernel of j^* is isomorphic to \mathbb{R} , hence $H^0(\mathbb{R}^{n+1} - X \times 0)$ is isomorphic to \mathbb{R} . \square

Theorem 19.1.1. *If $X, Y \subset \mathbb{R}^n$ are compact and homeomorphic then $H^p(\mathbb{R}^n - X) \cong H^p(\mathbb{R}^n - Y)$. In particular, this implies that $\mathbb{R}^n - X$ and $\mathbb{R}^n - Y$ have the same number of components.*

Proof. For $p > 0$

$$H^p(\mathbb{R}^n - X) \cong H^{p+n}(\mathbb{R}^{2n} - X \times 0) \cong H^{p+n}(\mathbb{R}^{2n} - 0 \times Y) \cong H^p(\mathbb{R}^n - Y)$$

and

$$H^0(\mathbb{R}^n - X) \cong H^0(\mathbb{R}^{2n} - X \times 0) \cong H^0(\mathbb{R}^{2n} - 0 \times Y) \cong H^0(\mathbb{R}^n - Y)/\mathbb{R}$$

\square

Theorem 19.1.2 (Invariance of Domain). *Let U be an open set in \mathbb{R}^n , and V a subspace of \mathbb{R}^n . If U is homeomorphic to V , then V is an open set in \mathbb{R}^n .*

Proof. Let $v \in V$. Then $h(v) \in U$. Now let D be a closed ball in \mathbb{R}^n centered at $h(v)$ and contained in U .

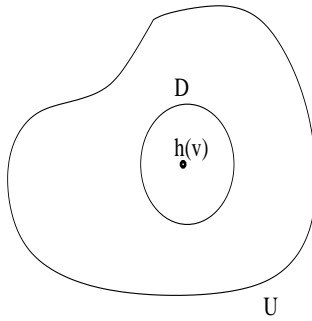

We have

$$H^0(\mathbb{R}^n - h^{-1}(D)) \cong H^0(\mathbb{R}^n - B^n) = \mathbb{R} \quad \text{if } n > 1.$$

Therefore $\mathbb{R}^n - h^{-1}(D)$ is connected. Let $S = \partial D$. Then

$$H^0(\mathbb{R}^n - h^{-1}(S)) \cong H^0(\mathbb{R}^n - S^{n-1}) = \mathbb{R}^2.$$

Hence $\mathbb{R}^n - h^{-1}(S)$ has two components each of which is open. Now $\mathbb{R}^n - h^{-1}(D)$ is open and connected, and $h^{-1}(\text{Int } D)$ is connected. Therefore $h^{-1}(\text{Int } D)$ is open, since $\mathbb{R}^n - h^{-1}(S)$ is the disjoint union of $\mathbb{R}^n - h^{-1}(D)$ and $h^{-1}(\text{Int } D)$. Therefore there is an open neighbourhood around $v \in V$, and hence it is open. \square

Example 19.1.3. We want to show that

$$H^i(\mathbb{C}P^n) = \begin{cases} \mathbb{R} & i = 0, 2, \dots, 2n, \\ 0 & \text{otherwise.} \end{cases}$$

Since $\mathbb{C}P^1 = S^2$ we know the result is true for $n = 1$. Now we proceed by induction. Let $U = \mathbb{C}P^n - \{pt\}$, and let V be a contractible open ball around the point. Then $U \cap V \simeq S^{2n-1}$. We can assume $U = \mathbb{C}P^n - \{[0 : 0 : \dots : 1]\}$. Consider the map $r: U \rightarrow \mathbb{C}P^n$ given by

$$r([z_0 : z_1 : \dots : z_n]) = [z_0 : z_1 : \dots : 0].$$

Now let $i: \mathbb{C}P^{n-1} \rightarrow U$ be the inclusion map. Then $r \circ i = 1$ and $i \circ r: U \rightarrow U$ is homotopic to the identity. The homotopy is given by

$$r_t([z_0 : z_1 : \cdots : z_n]) = [z_0 : z_1 : \cdots : tz_n].$$

Hence U deformation retracts onto $\mathbb{C}P^{n-1}$. Now look at the following part of the Mayer-Vietoris exact sequence:

$$H^{i-1}(U) \oplus H^{i-1}(V) \rightarrow H^{i-1}(U \cap V) \rightarrow H^i(\mathbb{C}P^n) \rightarrow H^i(U) \oplus H^i(V) \rightarrow H^i(U \cap V)$$

If i is not equal to $0, 2n - 1$ or $2n$, then $H^i(\mathbb{C}P^n) \cong H^i(U) \oplus H^i(V) \cong H^i(\mathbb{C}P^{n-1})$. Since $\mathbb{C}P^n$ is connected we know that $H^0(\mathbb{C}P^n) = \mathbb{R}$. If $i = 2n - 1$, then we obtain

$$0 \rightarrow H^i(\mathbb{C}P^n) \rightarrow 0$$

Therefore $H^{2n-1}(\mathbb{C}P^n) = 0$. If $i = 2n$, then we obtain

$$0 \rightarrow \mathbb{R} \rightarrow H^i(\mathbb{C}P^n) \rightarrow 0$$

Therefore $H^{2n}(\mathbb{C}P^n) = \mathbb{R}$.

Example 19.1.4. We shall compute the de Rham cohomology of $\mathbb{R}P^n$. One approach is to use the Mayer-Vietoris sequence with $U = \mathbb{R}P^n - \{\text{pt}\} \simeq \mathbb{R}P^{n-1}$ and V an open ball around $\{\text{pt}\}$. We shall take a different approach however. Let $\pi: S^n \rightarrow \mathbb{R}P^n$ be the quotient map. Now $\pi^*: \Omega^i(\mathbb{R}P^n) \rightarrow \Omega^i(S^n)$ is clearly injective. The image of π^* is the set of forms on S^n such that $a^*\omega = \omega$ (here a is the antipodal map). Since $a^*: \Omega^i(S^n) \rightarrow \Omega^i(S^n)$ has order 2 it breaks up into (± 1) -eigenspaces

$$\Omega^i(S^n) = \Omega_+^i(S^n) \oplus \Omega_-^i(S^n).$$

This decomposes the de Rham complex for S^n into direct sums.

$$\Omega^*(S^n) = \Omega_+^*(S^n) \oplus \Omega_-^*(S^n).$$

Hence $H^i(S^n) \cong H_+^i(S^n) \oplus H_-^i(S^n)$, where $H_\pm^i(S^n)$ is the (± 1) -eigenspace of a^* on $H^i(S^n)$. Therefore $H^i(\mathbb{R}P^n) \cong H_+^i(S^n)$. The map $a^*: H^n(S^n) \rightarrow H^n(S^n)$ is just multiplication by $(-1)^{n+1}$. Hence

$$H^i(\mathbb{R}P^n) = \begin{cases} \mathbb{R} & \text{if } i = 0 \text{ or } i = n \text{ with } n \text{ odd} \\ 0 & \text{otherwise.} \end{cases}$$

Definition 19.1.2. Let M be a closed, orientable n -dimensional manifold. We define a map from $H^n(M)$ to \mathbb{R} by integrating forms: Let $\omega \in \Omega^n(M)$ be a representative of an equivalence class of closed n -forms, then

$$\int_M \omega \in \mathbb{R}$$

Lemma 19.1.4. *The above definition is well-defined.*

Proof. We have to show that if we integrate an exact form we get zero. Let ω be an exact form, that is, $\omega = d\eta$. Then

$$\int_M d\eta = \int_{\partial M} \eta = 0.$$

□

Lemma 19.1.5. *Let ω be a closed k -form on S^k . Then ω is exact if, and only, if*

$$\int_{S^k} \omega = 0.$$

Hence $\int_{S^k} : H^k(S^k) \rightarrow \mathbb{R}$ is an isomorphism.

Proof. Suppose that ω is not exact. Then every closed k -form is cohomologous to some multiple of ω , since $\dim H^k(S^k) = 1$. We can easily construct a closed k -form on S^k which has non-zero integral: Work in a chart $U \cong \mathbb{R}^n$, and let f be a bump function on U such that $\int_{\mathbb{R}^n} f = 1$.

†

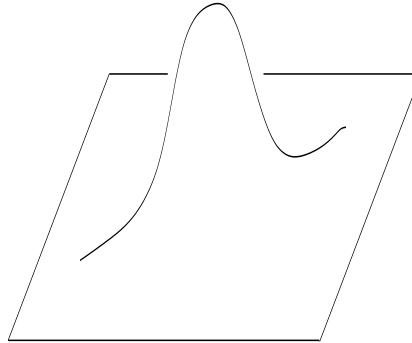

Now let $\omega' = f dx_1 \wedge \cdots \wedge dx_n$. Then $\int_M \omega' = \int_{\mathbb{R}^n} \omega = \int f = 1$. But $1 = \int_{S^k} \omega' = \int_{S^k} c\omega = c \int_{S^k} \omega = 0$, therefore ω is exact. □

Lemma 19.1.6. *Let ω be a compactly supported k -form on \mathbb{R}^k . Then ω is the exterior derivative of a compactly supported $k - 1$ -form if, and only if,*

$$\int_{\mathbb{R}^k} \omega = 0.$$

Proof. We can use stereographic projection to carry ω to a k -form ω on S^k . Now by the previous lemma $\omega' = dv$. Now dv is zero in some contractible neighbourhood U of the north pole N . Let \tilde{v} be a $k - 1$ form which agrees with v in some neighbourhood $V \subset U$ of N and is zero outside. Then $d\tilde{v} = 0$, which implies there exists a $k - 2$ form μ such that $d\mu = \tilde{v}$. Therefore $v = d\mu$ near N . Then $v - d\mu$ is zero near N , so it pulls back to a compactly supported form on \mathbb{R}^k . \square

Theorem 19.1.3. *Let M be a closed, connected orientable n -manifold. Then*

$$\int_M : H^n(M) \longrightarrow \mathbb{R}$$

is an isomorphism.

Proof. Let U be an open set diffeomorphic to \mathbb{R}^n , and let ω be a n -form compactly supported in U with $\int_M \omega = 1$. Now let ω' be a compactly supported k -form in U . Then $\int_M \omega' = c = c \int_M \omega$. Therefore $\int_M \omega' - c\omega = 0$, hence by the previous lemma ω' is cohomologous to a scalar multiple of ω . Now choose open sets U_1, U_2, \dots, U_N covering M , each of which is deformable into U by a smooth isotopy. Now choose a partition of unity subordinate to this cover. Now let μ be a k -form on M , then $\mu = \sum_{i=1}^N \rho_i \mu$. Now $\rho_i \mu$ is a k -form which is cohomologous to some scalar multiple of ω . Hence $\int_M : H^n(M) \longrightarrow \mathbb{R}$ is an isomorphism. \square

Another way to cook up a k -form ω on M such that $\int_M \omega \neq 0$ is the following: Choose a Riemannian metric on M . Let v_1, \dots, v_n be tangent vectors based at $p \in M$ and $\{e_1, \dots, e_n\}$ be a positively oriented orthonormal basis of $T_p M$. Now Define $\omega(v_1, \dots, v_n) =$ determinant of transformation $e_i \rightarrow v_i$. Then $\omega(e_1, \dots, e_n) = 1$ and $\int_M \omega = \text{vol}(M) > 0$. ω is called the volume form.

Theorem 19.1.4. *Let $f : M^n \longrightarrow N^n$ be a smooth map between connected, closed oriented manifolds. Then the induced map $f^* : H^n(N) \longrightarrow H^n(M)$ is*

given by $x \rightarrow \deg(f)x$.

$$\begin{array}{ccc} H^n(M) & \xleftarrow{f^*} & H^n(N) \\ \downarrow f_M & & \downarrow f_N \\ \mathbb{R} & \xleftarrow{x \deg f} & \mathbb{R} \end{array}$$

Proof. Let $y \in N$ be a regular value. Choose an n -form ω supported on V such that $\int_V \omega = 1$.

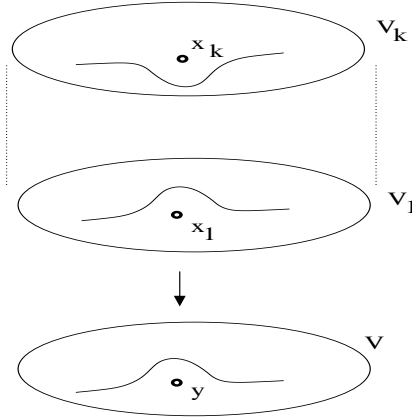

Hence

$$\int_{V_i} f^* \omega = \epsilon_{x_i} = \text{sign}(df_{x_i}).$$

We then obtain the result by adding up all the signs

$$\int_M f^* \omega = \sum_i \int_{V_i} f^* \omega = \sum \epsilon_{x_i} = \deg f.$$

□

Corollary 19.1.1. Let $f: X \rightarrow Y$ and $g: Y \rightarrow Z$ be smooth maps between connected, closed oriented manifolds of the same dimension n . Then

$$\deg(g \circ f) = \deg(f) \deg(g).$$

Proof. Choose $\omega \in \Omega^n(Z)$ so that $\int_Z \omega \neq 0$. Then

$$\begin{aligned}
 \deg(g \circ f) \int_Z \omega &= \int_X (g \circ f)^*(\omega) \\
 &= \int_X f^*(g^*(\omega)) \\
 &= \deg(f) \int_Y g^*(\omega) \\
 &= \deg(f) \deg(g) \int_Z \omega.
 \end{aligned}$$

□

Example 19.1.5. We can cover T^2 with the two open sets U and V such that U and V are both homotopic to S^1 and $U \cap V$ is homotopic to the disjoint union of two circles.

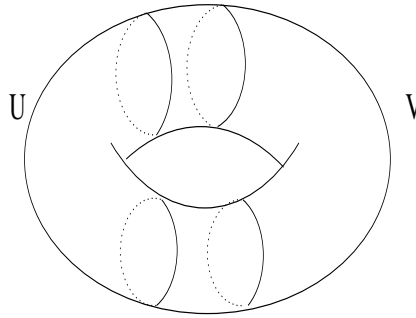

We then have the following Mayer-Vietoris sequence

$$\begin{aligned}
 0 \rightarrow H^0(T^2) \rightarrow H^0(U) \oplus H^0(V) \rightarrow H^0(U \cap V) \rightarrow \\
 H^1(T^2) \rightarrow H^1(U) \oplus H^1(V) \rightarrow H^1(U \cap V) \rightarrow H^2(T^2) \rightarrow 0
 \end{aligned}$$

We know already that $H^0(T^2) = H^2(T^2) = \mathbb{R}$. So all we have to do is find $H^1(T^2)$. The image of the map $H^1(U \cap V) \rightarrow H^2(T^2)$ is isomorphic to \mathbb{R} . Working back we find that the image of the map $H^1(T^2) \rightarrow H^1(U) \oplus H^1(V)$ is isomorphic to \mathbb{R} . The image of the map $H^0(T^2) \rightarrow H^0(U) \oplus H^0(V)$ is isomorphic to \mathbb{R} . Therefore the kernel of the map $H^0(U) \oplus H^0(V) \rightarrow H^0(U \cap V)$ is isomorphic to \mathbb{R} . Working forward we find that the kernel of the map $H^1(T^2) \rightarrow H^1(U) \oplus H^1(V)$ is isomorphic to \mathbb{R} . Therefore $H^1(T^2) = \mathbb{R}^2$.

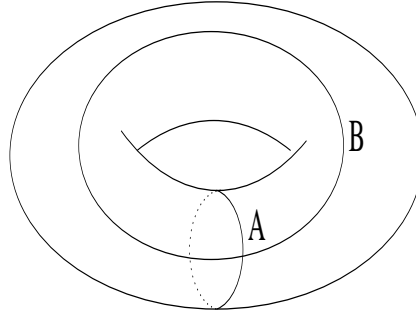

The exercise below illustrates what the generators are for $H^1(T^2)$.

Exercises

1. Let $p_1: S^1 \times S^1 \rightarrow S^1$ and $p_2: S^1 \times S^1 \rightarrow S^1$ be the projection maps onto the first and second factors respectively. Let ω be a generator for $H^1(S^1)$. Show that the 1-forms $p_1^*(\omega)$ and $p_2^*(\omega)$ are linearly independent.
2. We can actually generalise the previous question. Let T^n be the n -torus, and let $p_i: T^n \rightarrow S^1$ be the projection onto the i -th factor. Now define $\omega_i = p_i^*(\omega)$, where ω is a generator for $H^1(S^1)$. Show that the set

$$\{\omega_{i_1} \wedge \cdots \wedge \omega_{i_p} \in H^p(T^n) : 1 \leq i_1 \leq \cdots \leq i_p \leq n\}$$

is linearly independent. Hence

$$\dim H^p(T^n) \geq \binom{n}{p}.$$

3. Show that the function $f: \mathbb{R}^n \rightarrow \mathbb{R}$ given by

$$f(x_1, \dots, x_n) = \sum_{i=1}^n \sin^2(\pi x_i)$$

is a Morse function. Show also that this function induces a Morse function on T^n and that the number of critical points of index λ is $\binom{n}{\lambda}$. There is a result in Morse theory which says that $C_\lambda \geq \dim H^\lambda(M)$, where C_λ denotes the number of critical points of index λ of the Morse function $M \rightarrow \mathbb{R}$. This result is called the Morse inequality. Use the Morse inequality to deduce the fact that

$$\dim H^p(T^n) = \binom{n}{p}.$$

4. Use the two previous exercises to show that the cohomology algebra of T^n is the exterior algebra $\Lambda[\omega_1, \dots, \omega_n]$.

Proposition 19.1.2. *Let M be a closed, oriented n -manifold. Then the Euler characteristic is equal to*

$$\chi(M) = \sum_{i=0}^n (-1)^i \dim H^i(M).$$

Corollary 19.1.2. *The Euler characteristic is a homotopy invariant.*

Proposition 19.1.3. *Let U and V be open sets of a smooth manifold. If U, V and $U \cap V$ have finite dimensional de Rham cohomology, the same is true for $U \cup V$, and*

$$\chi(U \cup V) = \chi(U) + \chi(V) - \chi(U \cap V).$$

Proposition 19.1.4. *Let M be a compact manifold. Then*

$$\chi(2M) = 2\chi(M) - \chi(\partial M).$$

Proof. Let U and V be open sets of $2M$ such that $U \cup V = 2M$, $U \cap V \simeq \partial M$ and $U \simeq V \simeq M$. Using the previous proposition and the fact that the Euler characteristic is a homotopy invariant allows us to deduce the result. \square

Theorem 19.1.5. *Let M be a compact manifold. Then $\chi(\partial M)$ is even.*

Proof. If the dimension of M is even, then ∂M is an odd dimensional closed manifold, therefore $\chi(\partial M) = 0$. If the dimension of M is odd, then $\chi(2M) = 0$ for the same reason as in the previous sentence. Therefore $\chi(\partial M) = 2\chi(M)$. \square

Exercises

1. Prove proposition 38. (Hint: Use the Mayer-Vietoris sequence.)
2. Show that $\mathbb{C}P^{2n}$ and $\mathbb{R}P^{2n}$ cannot be the boundary of a compact manifold. Show, however, that $\mathbb{C}P^{2n+1}$ can be the boundary of a compact manifold.
3. Show that the Euler characteristic of a compact, connected odd dimensional manifold may not be zero.

4. Use a Morse function on $S^m \times S^n$ to show that

$$H^p(S^m \times S^n) = \begin{cases} \mathbb{R} & \text{if } p = 0, n, m, n + m, \\ 0 & \text{otherwise} \end{cases}$$

if $m \neq n$ and

$$H^p(S^n \times S^n) = \begin{cases} \mathbb{R} & \text{if } p = 0, 2n, \\ \mathbb{R}^2 & \text{if } p = n, \\ 0 & \text{otherwise} \end{cases}$$

5. Use the previous exercise to show that any map $f: S^{m+n} \rightarrow S^n \times S^m$ has degree zero.

6. Let Σ_g be a closed orientable surface of genus g . Show that

$$H^p(\Sigma_g) = \begin{cases} \mathbb{R} & \text{if } p = 0, 2, \\ \mathbb{R}^{2g} & \text{if } p = 1, \\ 0 & \text{otherwise.} \end{cases}$$

7. Show that

$$\sum_{p=0}^n (-1)^p \binom{n}{p} = 0.$$

8. Let A be a matrix in $GL_2(\mathbb{Z})$. Show that the induced map $H^1(T^2) \rightarrow H^1(T^2)$ is given by A^* .

9. Show that the map $\tilde{A}: \mathbb{R}^2 \rightarrow \mathbb{R}^2$ given by $(x, y) \rightarrow (x, 1 - y)$ induces a diffeomorphism $A: T^2 \rightarrow T^2$. Now the Klein bottle is defined to be $K^2 = T^2 / \sim$, where $q \sim Aq$. Show that

$$H^p(K^2) = \begin{cases} \mathbb{R} & \text{if } p = 0, 1, \\ 0 & \text{otherwise.} \end{cases}$$

Now deduce that the Klein bottle is not orientable, and hence cannot be embedded in \mathbb{R}^3 .

10. Show that $\mathbb{R}P^{2n}$ does not retract onto $\mathbb{R}P^{2k-1}$, where $k \leq n$.

11. Let C be the curve $S^1 \times \{x_0\} \subset S^1 \times S^1$ on the torus. Show that the Dehn twist (see question 7 on page 119) in C has infinite order. Hint: Show that the induced map in the first cohomology is given by the matrix

$$\begin{pmatrix} 1 & 1 \\ 0 & 1 \end{pmatrix}.$$

12. Show that the volume form for S^{n-1} , where S^{n-1} has the induced Riemannian metric from standard Riemannian metric of \mathbb{R}^n , is

$$\omega = \sum_{i=1}^n (-1)^{i-1} x_i dx_1 \wedge \cdots \wedge \tilde{dx}_i \wedge \cdots \wedge dx_n$$

and that the volume form for D^n is $dx_1 \wedge \cdots \wedge dx_n$. Consider the form

$$\omega = \sum_{i=1}^n (-1)^{i-1} x_i dx_1 \wedge \cdots \wedge \tilde{dx}_i \wedge \cdots \wedge dx_n$$

on D^n . Now

$$\text{Vol}(S^{n-1}) = \int_{S^{n-1}} \omega = \int_{D^n} d\omega = n \text{Vol}(D^n)$$

since $d\omega = n dx_1 \wedge \cdots \wedge dx_n$. Show by induction on m that

$$\text{Vol}(D^{2m}) = \frac{\pi^m}{m!}, \quad \text{Vol}(D^{2m+1}) = \frac{2^{2m+1} m! \pi^m}{(2m+1)!}.$$

Hence deduce that

$$\text{Vol}(S^{2m-1}) = \frac{2\pi^m}{(m-1)!}, \quad \text{Vol}(S^{2m}) = \frac{2^{2m+1} m! \pi^m}{2m!}.$$

19.2 Thom Class

Let X be a manifold and $M \subset X$ a neat submanifold, which is transversely oriented. Then there is a closed k -form $\omega_M \in \Omega^k(X)$ supported in the ϵ -neighbourhood of M with the property that for every closed oriented k -manifold $N \subset X$ such that N is transverse to M we have $\int_N \omega_M = I(N, M)$. Moreover, $[\omega_M]$ depends only on M , it is called the *Thom Class* or the *Poincaré Dual* of M .

Example 19.2.1. Let $X = S^1$ and M be a point. Then, $[\omega_M] \in H^1(S^1) = \mathbb{R}$. Let $N = S^1$, then $\int_N \omega_M = I(N, M) = 1$.

Example 19.2.2. Let X be a closed, connected, oriented manifold. Then $[\omega_{pt}]$ is a basis of $H^n(X) = \mathbb{R}$.

In certain cases one can construct ω_M . For example, If $X = \mathbb{R}^k$ and $M = \{0\}$, then $\omega_M = f dx_1 \wedge \cdots \wedge dx_k$, where f is a bump function. More generally, if the normal bundle of M is trivial, that is the total space is $M \times \mathbb{R}^k$, then ω_M is constructed by pulling back the form $f dx_1 \wedge \cdots \wedge dx_k$ under the map $p: M \times \mathbb{R}^k \rightarrow \mathbb{R}^k$.

Example 19.2.3. Let T^2 be the torus, and let A and B be as in the picture below.

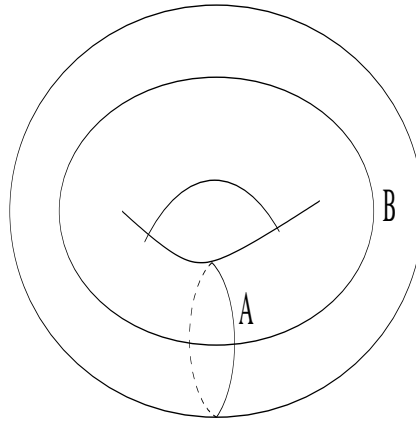

Both ω_A and ω_B are closed one forms which vanish outside of an epsilon neighbourhood of A and B . If we think of T^2 as $\mathbb{R}^2/\mathbb{Z}^2$, then ω_A is given by $\rho(x)dx$ and ω_B is given by $\sigma(y)dy$, where both ρ and σ are bump functions. One can check that

$$\int_B \omega_A = I(B, A) = \pm 1.$$

and

$$\int_B \omega_B = I(B, B) = 0$$

This proves that the forms ω_A and ω_B are linearly independent. Hence they generate $H^1(T^2)$.

Theorem 19.2.1. Suppose $A, B \subset X$ intersect transversely and $C = A \cap B$. Then the wedge product $\omega_A \wedge \omega_B$ represents the Thom class of C .

19.3 Curvature

Let $\Sigma \subseteq \mathbb{R}^{n+1}$ be a connected, closed hypersurface. The interesting case is when $n = 2$.

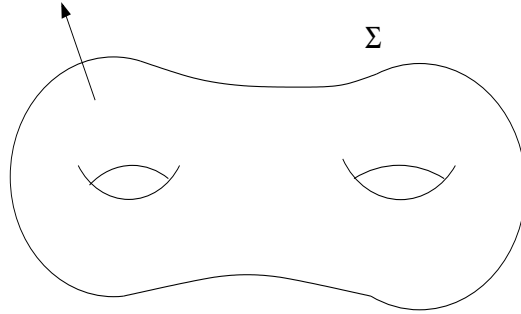

Consider the Gauss map $g: \Sigma \rightarrow S^2$, $g(x) = \text{outward unit normal}$. What is the degree of g ? If $\Sigma = S^2$, then $g = \text{id}$ and the degree of g is one.

Theorem 19.3.1. *We have*

$$\deg(g) = \frac{1}{2}\chi(\Sigma),$$

provided n is even.

Proof. Let N be an ϵ -neighbourhood. Then

$$N \cong \Sigma \times [-\epsilon, \epsilon].$$

Define a vector field on N in the following way: Choose a vector field on Σ and tangent to Σ all of whose zeroes are non-degenerate, then extend to $\Sigma \times [-\epsilon, \epsilon]$ by $V(x, t) = v(x) + tg(x)$.

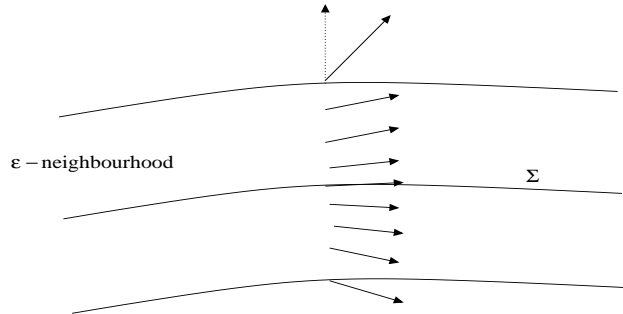

Let U be the union of small balls around the points where V vanishes. Define a Gauss map $G: N - U \rightarrow S^2$ by $(x, t) \rightarrow V(x, t)/\|V(x, t)\|$. Then $\deg(G|_{\Sigma \times \{\epsilon\}}) = \deg(g)$. Now G is homotopic to g on $\Sigma \times \{\epsilon\}$, since the distance between them is less than $\frac{\pi}{2}$. Also, $\deg(G|_{\Sigma \times \{-\epsilon\}}) = \deg(g)$: $G \simeq a \circ g$ on $\Sigma \times \{-\epsilon\}$ (a is the antipodal map, which is orientation reversing,

since n is even) and $\Sigma \times \{-\epsilon\} \cong -\Sigma$. Now $\deg(G|_{\partial U_i}) = \text{ind}_{x_i} V$, where U_i is a neighbourhood of x_i . Hence $\deg(G|_{\partial U_i}) = \text{ind}_{x_i} v$, since

$$dV = \begin{pmatrix} & & & 0 \\ & & & \vdots \\ & dv & & 0 \\ 0 & \dots & 0 & 1 \end{pmatrix}.$$

Therefore $\sum \deg(G|_{\partial U_i}) = \sum_i \text{ind}_{x_i} v = \chi(\Sigma)$. The boundary theorem implies $2 \deg(g) = \chi(\Sigma)$, hence $\deg(g) = \frac{1}{2}\chi(\Sigma)$. \square

Remark: The theorem is false if n is odd, since the Euler characteristic of an odd dimensional manifold is 0.

Definition 19.3.1. The *Gaussian Curvature* of Σ at p is $\det(dg)_p$, and is denoted $\kappa(p)$

Example 19.3.1. Let S_r be a sphere of radius r , that is, the set of points in \mathbb{R}^3 that satisfy the equation $x^2 + y^2 + z^2 = r^2$. The Gauss map $g: S_r \rightarrow S^2$ is given by $g(x, y, z) = \frac{1}{r}(x, y, z)$, which implies that $\det(dg)_p = \frac{1}{r^2}$.

Theorem 19.3.2 (Gauss–Bonnet). *The global curvature is a topological invariant. More precisely, the following formula holds:*

$$\int_{\Sigma} \kappa dA = 2\pi\chi(\Sigma).$$

Proof. Let ω_{S^2} be the area form on S^2 . Then

$$\begin{aligned} \int_{\Sigma} g^*(\omega_{S^2}) &= \int_{S^2} \omega_{S^2} \deg(g) \\ &= 4\pi \frac{1}{2} \chi(\Sigma) \\ &= 2\pi \chi(\Sigma) \end{aligned}$$

The first equality is due to the determinant theorem. \square

20 Duality

Definition 20.0.2. Let A and B both be vector spaces over \mathbb{R} . Then a bilinear pairing $A \times B \rightarrow \mathbb{R}$ is said to be *nonsingular* if the maps $A \rightarrow \text{Hom}(B, \mathbb{R})$ and $B \rightarrow \text{Hom}(A, \mathbb{R})$ are both isomorphisms.

Theorem 20.0.3 (Poincaré Duality). *let M be a closed connected orientable n -manifold. Then the bilinear pairing $H^p(M) \times H^{n-p}(M) \rightarrow \mathbb{R}$ given by*

$$(\omega, \eta) \longrightarrow \int \omega \wedge \eta$$

is nonsingular.

Corollary 20.0.1. *If M is a closed connected orientable n -manifold, then for each basis element of $\omega \in H^p(M)$, there exists an element $\eta \in H^{n-p}(M)$ such that $\omega \wedge \eta$ is the basis element of $H^n(M)$.*

Proof. Since ω is a basis element of $H^p(M)$, there exists a $\phi \in \text{Hom}(H^p(M), \mathbb{R})$ such that $\phi(\omega) = 1$. Now by the nonsingularity of the wedge product pairing, ϕ is realized by taking the wedge product with an element $\eta \in H^{n-p}(M)$ and then integrating over M . So $\omega \wedge \eta$ is the basis element of $H^n(M)$. \square

Theorem 20.0.4. *The cohomology algebra $H^*(\mathbb{C}P^n)$ is a truncated polynomial algebra*

$$H^*(\mathbb{C}P^n) = \mathbb{R}[c]/(c^{n+1}),$$

where c is a non-zero class in degree two, and (c^{n+1}) is the ideal generated by c^{n+1} .

Proof. This is certainly true for $n = 1$. Now we proceed by induction. The inclusion $i: \mathbb{C}P^{n-1} \rightarrow \mathbb{C}P^n$ induces an isomorphism

$$i^*: H^p(\mathbb{C}P^n) \longrightarrow H^p(\mathbb{C}P^{n-1})$$

for $p \leq 2n - 2$. Hence $c^{n-1} \neq 0$ in $H^{2n-2}(\mathbb{C}P^n)$, and the pairing

$$H^2(\mathbb{C}P^n) \times H^{2n-2}(\mathbb{C}P^n) \longrightarrow H^{2n}(\mathbb{C}P^n)$$

implies that $c^n \neq 0$. \square

Exercises

1. Let $f: \mathbb{C}P^{2n} \rightarrow \mathbb{C}P^{2n}$ be a smooth map. Show that the degree of f is non-negative. Exhibit an orientation reversing diffeomorphism $f: \mathbb{C}P^{2n+1} \rightarrow \mathbb{C}P^{2n+1}$.

2. Show that any map $f: \mathbb{C}P^m \rightarrow \mathbb{C}P^n$ induces the zero homomorphism

$$f^*: H^p(\mathbb{C}P^n) \rightarrow H^p(\mathbb{C}P^m)$$

for $p \neq 0$ when $m > n$.

3. Prove that $\pi: S^{2n+1} \rightarrow \mathbb{C}P^n$ is not null-homotopic. (Hint: Suppose that $F: S^{2n+1} \rightarrow \mathbb{C}P^n$ is a homotopy such that F_0 is a constant and $F_1 = \pi$. Define $g: D^{2n+2} \rightarrow \mathbb{C}P^n$ by $g(tz) = F(z, t)$, $z \in S^{2n+1}$, $t \in [0, 1]$. Now define $h: D^{2n+2} \rightarrow \mathbb{C}P^{n+1}$ by

$$h(z_0, z_1, \dots, z_n) = \left[z_0 : z_1 : \dots : z_n : \left(1 - \sum_{j=0}^n |z_j|^2 \right)^{\frac{1}{2}} \right]$$

and observe that h maps the open disc bijectively onto $\mathbb{C}P^{n+1} - \mathbb{C}P^n$. Moreover, h restricted to S^{2n+1} is the composite of π with the inclusion $i: \mathbb{C}P^n \rightarrow \mathbb{C}P^{n+1}$. Now find $f: \mathbb{C}P^{n+1} \rightarrow \mathbb{C}P^n$ so that $f \circ h = g$ and argue that f is continuous. Observe that $f \circ i = id$. Now use the previous exercise.

4. Let $f: M \rightarrow \mathbb{R}$ be a Morse function on a closed, connected orientable n manifold with only 3 critical points. Show that these critical points have index 0, $n/2$ and n . Hence this implies the dimension of the manifold is even.
5. Let $f: M \rightarrow N$ be a map between two closed, connected and oriented manifolds of the same dimension n . Also, suppose that the degree of f is not zero. Prove that the induced map

$$f^*: H^p(N) \rightarrow H^p(M)$$

is injective for all p .

6. Show that non-zero degree maps from Σ_g to Σ_h do not exist if $g < h$.
7. Let M be a closed orientable manifold of dimension n , where $n = 4k+2$. Show using Poincaré duality that $\chi(M)$ is even.
8. Show that

$$\binom{n}{p} = \binom{n}{n-p}.$$

9. Let M be a closed, connected orientable 4-manifold such that its cohomology algebra is additively isomorphic to that of $\mathbb{C}P^2$. Show that the cohomology algebra of M is isomorphic to the cohomology algebra of $\mathbb{C}P^2$.
10. Show that $S^2 \times S^4$ is not homotopy equivalent to $\mathbb{C}P^3$. Hint: Show that their cohomology algebras are not isomorphic.
11. The *Lefschetz number* of a map $f: X \rightarrow X$, where X is a compact manifold, is

$$L(f) = \sum_{i=0}^n (-1)^i \text{tr}(f^*: H^i(X) \rightarrow H^i(X)).$$

Here $\text{tr}(f^*: H^i(X) \rightarrow H^i(X))$ is the trace of the linear map

$$f^*: H^i(X) \rightarrow H^i(X).$$

It is a fact that if the Lefschetz number is non-zero, then f has a fixed point. Show that any map $f: \mathbb{C}P^{2n} \rightarrow \mathbb{C}P^{2n}$ has a fixed point. Also, show that a map $f: \mathbb{C}P^{2n+1} \rightarrow \mathbb{C}P^{2n+1}$ has a fixed point if $f^*(\omega) \neq -\omega$, where ω is the generator of $H^1(\mathbb{C}P^{2n+1})$. Now construct a map $f: \mathbb{C}P^{2n+1} \rightarrow \mathbb{C}P^{2n+1}$ without fixed points.

21 Subbundles and Integral Manifolds

A k -dimensional distribution Δ on M is a k -dimensional subbundle of TM , that is, Δ is a subset of TM which is also a k -dimensional vector bundle with respect to the map $\pi|_{\Delta}: \Delta \rightarrow M$. In other words for each $p \in M$ there exists a neighbourhood U and k vector fields X_1, \dots, X_k such that $X_1(q), \dots, X_k(q)$ are a basis for Δ_q for all $q \in U$. A k -dimensional submanifold N of M is called an integral manifold of Δ if for every $p \in N$ we have

$$i_*(N_p) = \Delta_p \quad \text{where } i: N \rightarrow M \text{ is the inclusion map.}$$

Example 21.0.2. Let $M = \mathbb{R}^3$ and $\Delta = \text{span}(\frac{\partial}{\partial x}, \frac{\partial}{\partial y})$. Then the integral manifolds are the manifolds which are parallel to \mathbb{R}^2 .

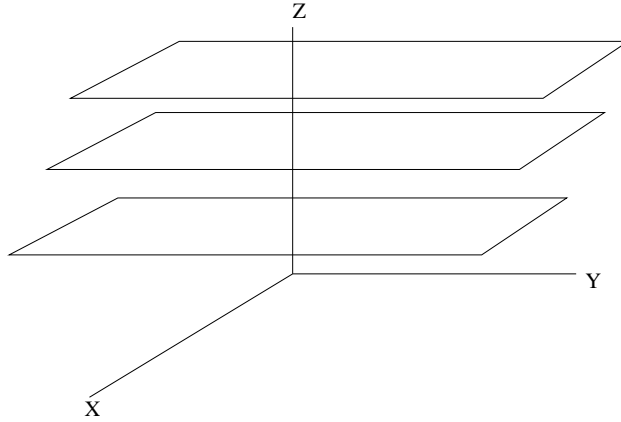

Definition 21.0.3. A distribution Δ is *integrable* if for every $X, Y \in \Delta$ it follows that $[X, Y] \in \Delta$.

Theorem 21.0.5 (Frobenius). *Let Δ be integrable. Then there are integrable manifolds through every point $p \in M$. Moreover, Δ is locally standard, i.e., $\Delta = \text{span}(\frac{\partial}{\partial x_1}, \dots, \frac{\partial}{\partial x_k})$.*

Proof. Define vector fields X_1, \dots, X_k near p such that $X_i \in \Delta$, $\text{Proj}(X_i) = \frac{\partial}{\partial x_i}$ and $\Delta = (X_1, \dots, X_k)$. We shall show that $[X_i, X_j] = 0$. We have $\text{proj}[X_i, X_j] = [\text{proj}(X_i), \text{proj}(X_j)] = [\frac{\partial}{\partial x_i}, \frac{\partial}{\partial x_j}] = 0$. Also, $[X_i, X_j] \in \Delta$ by integrability. Therefore $[X_i, X_j] = 0$, since proj restricted to Δ is one-to-one. Therefore $\{X_1, X_2, \dots, X_k\}$ is standard, which implies Δ is standard. \square

Example 21.0.3. Let $M = \mathbb{R}^3$,

$$X = \frac{\partial}{\partial x} + y \frac{\partial}{\partial z}, \quad Y = \frac{\partial}{\partial y}$$

and $\Delta = \text{span}(X, Y)$. Now

$$[X, Y] = -\frac{\partial}{\partial z} \notin \text{span}(X, Y)$$

Hence this distribution is not integrable.

We shall now give a reformulation of Frobenius using forms. Let $I(\Delta)$ denote the set of all forms ω that vanish on all tuples of vectors in Δ . Then $I(\Delta)$ is an ideal in $\Lambda^*(M)$.

Exercise

1. Show that $I(\Delta)$ is an ideal.

Theorem 21.0.6. Δ is integrable if, and only if, $d(I(\Delta)) \subseteq I(\Delta)$.

The key identity for the proof is: If ω is a one-form, X and Y are vector fields then

$$d\omega(X, Y) = X(\omega(Y)) - Y(\omega(X)) - \omega([X, Y]).$$